

QST

devoted entirely to

amateur radio

december
1935
25 cents

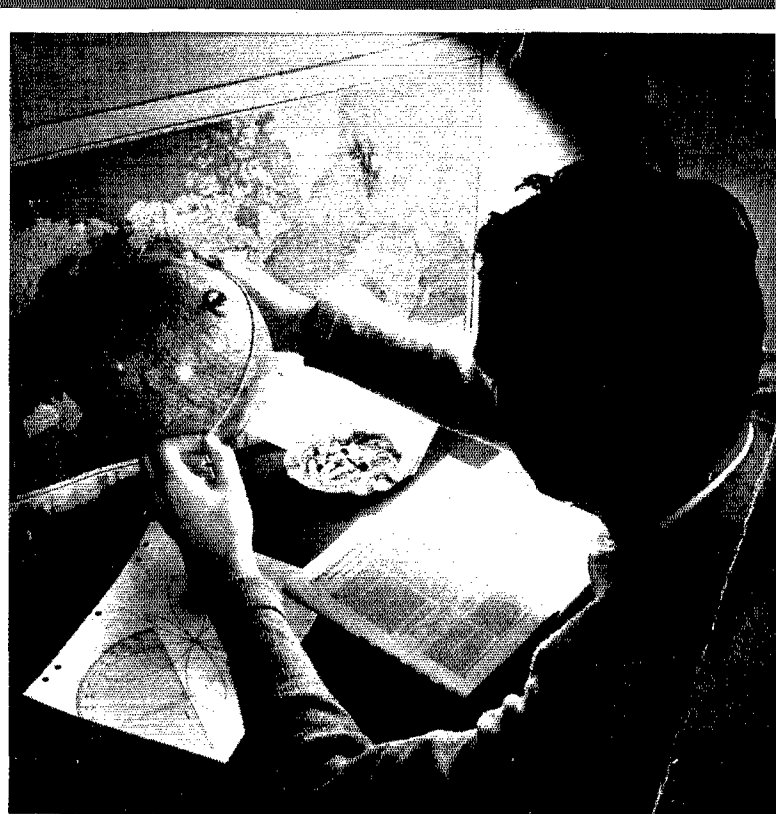

600 A

the Newest COLLINS TRANSMITTER

THE NEW 600A illustrates the technical leadership which keeps Collins transmitters far ahead of imitative competition. Any one of the following Collins developments is of sufficient importance to make the 600A your choice:

- Maximum permissible CW output (700-800 watts) with 200 watts radiophone output.
- New antenna network suited for use with the MULTIBAND ANTENNA.
- New high stability oscillator.
- New precision flush dials.
- Inductive neutralization resulting in increased output.
- Full automatic control and overload protection.
- Rapid frequency shift including provision for ten meter operation.

Price-conscious amateurs will be glad to know that these technical improvements have not been accompanied by an increase in price. Instead, the 600A brings high power into the medium price field.



Constructional data on the Multi-band Antenna and a complete description of the 600A are included in the December Collins Signal. A card will serve to place your name on the mailing list without obligation.

COPYRIGHT C. R. CO. 1935

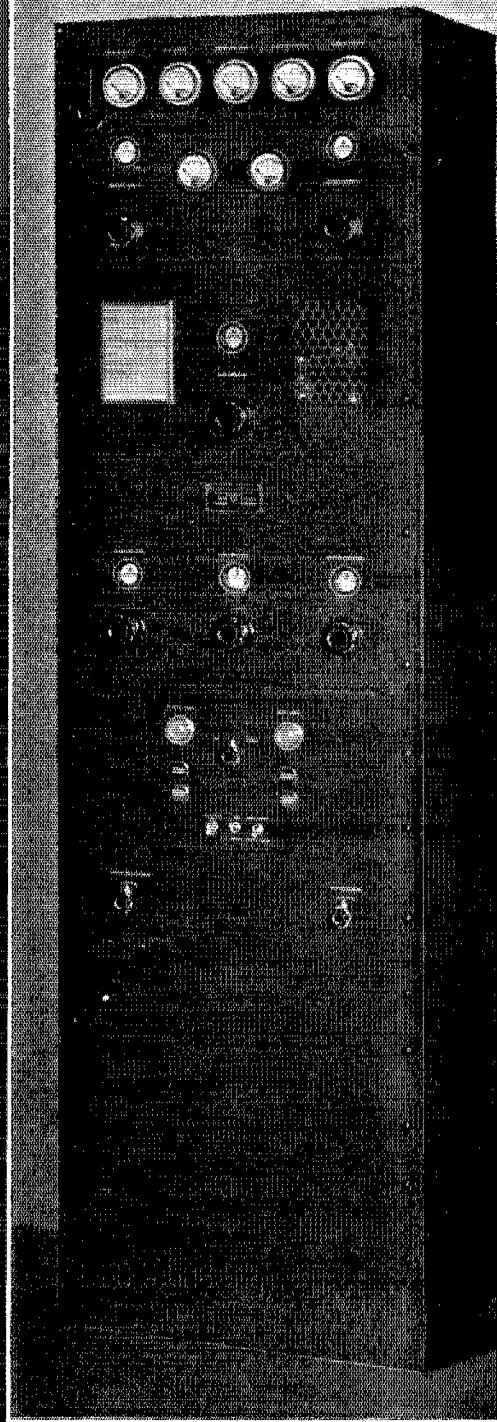

Collins Radio Company

CEDAR RAPIDS

New York
11 West 42nd St.



IOWA, U. S. A.

Mexico City
Edificio "La Nacional"

MARINE *Transmitting Equipment*

FOR ALL PURPOSES

Accent on modernity . . . that's the deluxe MARINE group of transmitters in a phrase. In their striking black cabinets, Marine has compactly incorporated all the latest "wrinkles" in transmitter design—all those "efficiency" features which have caused Marine to assume instant leadership in the field. Why "wish" for a perfect rig? Marine is your answer!

VISUAL OSCILLOSCOPIC MODULATION CONTROL ON MARINE TRANSMITTERS

Marine 140B: 100 Watt Ultra Modern High Frequency Transmitter

- Power Output: Conservatively rated at 100 watts, CW and phone.
- Frequency range: 15,000 to 1,500 K.C.
- Modulation Control: Built in Cathode-Ray Oscilloscope allowing for instantaneous visual modulation. Permits maintenance of 100% modulation control.
- Permanent Neutralization: Changing bands or using different antennas will have absolutely no effect on the neutralization.
- High Fidelity Audio Channel: Speech amplifier has frequency response of 30 to 10,000 cycles, within ± 1.5 db with a gain of 125 db.
- Dimensions: 60" long x 19½" wide x 15" deep.

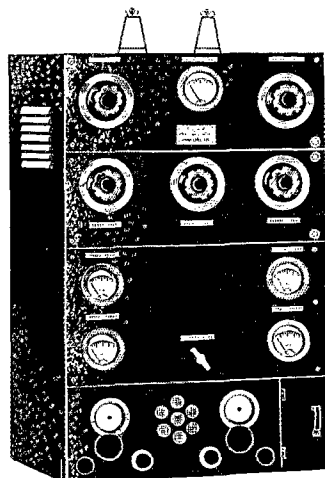
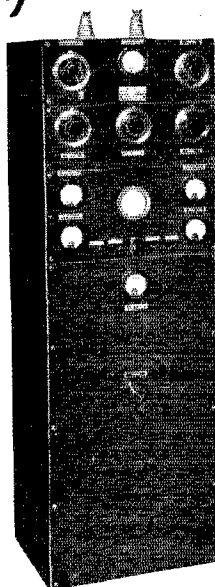

Marine Radio Company manufactures transmitting equipment of all types, for broadcast, commercial, aircraft and police work.

MARINE 750B

The most powerful transmitter permitted by the government for amateur use. 1000 watt phone and CW. This rig is the finest of its type available today.

NOW — A portable 40 watt Phone and CW rig. Built along the MARINE quality standards, the Model 35BP is supplied complete with receiver. Originally designed for airplane work this unit is compact and sufficiently light of weight for one man to carry. Ideal for vacations, hamfests, exhibits and for the business executive on long trips.

Here is the story—short and sweet.

- Class B Modulation
- Three Stages Crystal Buffer Amplifier
- All Band Operation
- Antenna Matching Network
- Receiver 1 stage tuned R.F., Detector, 2 stages audio, Built in Dynamic Speaker
- Nine tube Super-het receiver with built in dynamic speaker optional
- Complete in one cabinet



You are assured of uninterrupted operation with all Marine Radio Apparatus. The Marine Radio iron-clad unconditional-guarantee absolutely protects you.

Illustrated descriptive catalog and photographic literature gladly furnished upon request.

MARINE

General Offices and Plant

124-11 101st AVENUE
RICHMOND HILL, NEW YORK

Radio Company



PATTERSON PR-16

Here she is — fellas! The talk of the air! Orders from all parts of the world, placed by radio enthusiasts, are being filled! Universal confidence in the yearly advancement of the PR Models has again been expressed.

Every desire for improved all-wave reception has been anticipated by Patterson engineers. Every possible improvement over previous PR Models has been made. Every worth-while new development has been incorporated. Complete, absolutely nothing else to buy.

PR-16K Console less crystal \$125.70. With crystal (PR-16CK) \$131.70. Chassis also available.

PR-16 \$95⁷⁰
COMPLETE WITH 16 TUBES AND 12 HEAVY DUTY PATTERSON ENLARGED SPEAKERS WITH CRYSTAL \$10.70

1936
Radio Equipment



THE NEW SUPER SKYRIDER

Nine metal tubes . . . DuoMicro-Vernier Bandspread . . . Iron Core IP's . . . Improved Crystal Circuit . . . Five Bands 7.4 to 550 meters . . . improved sensitivity, selectivity and signal to noise ratio . . . Automatic volume control . . . "Low Boost" control.

Acclaimed as the most popular short wave receiver of 1935, the Hallicrafter's SUPER SKYRIDER left little to be desired. You can't go wrong.

Your cost \$79.50
 With Crystal (Model SX9) \$89.50

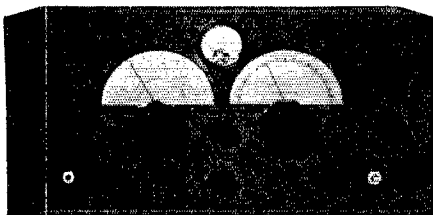

The RME-69 Single Signal Super

A real instrument for the amateur and his communication requirements. The circuit of the RME-69 will give you the type of performance you are looking for. The set is designed to operate as well on controlled carrier as it does on steady signal.

- Six band tuning ● Planetary-vernier dial mechanism ● Full electrical band spread ● Calibrated microvolt R meter tuning
- Built in monitor circuit ● Six volt tubes ● Individual Dial operation ● I.F. transformer with fixed coupling.

The RME-69 Super Receiver, complete with crystal, set of tubes, Rola speaker housed in baffle. Nothing else to buy — \$134.90.

SARGENT MODEL 10

A complete, self-contained Communication Type All-Wave Receiver.

- Covers broadcast band
- Tuning dial calibrated in M.C.
- Adjustable, calibrated band spreader ● Coil switch for wave changing ● Doublet or regular antenna ● Supplied for any operating voltage.

Your cost model 10SA 15-550 meters. \$34.50
 Your cost model 10MA 15-1500 meters. \$39.50

Also available in wavelength ranges from 15 to 17,000 meters.

SARGENT MODEL 20

- One stage pre-selection
- A.V.C. and Manual Volume Control ● Adjustable calibrated band spreader ● Coil switching — no plug-in coils ● Fractional microvolt sensitivity ● Razor edge selectivity.

Your cost model 20SA 15-550 meters. \$59.50

Your cost model 20MA 15-1500 meters. \$67.50

MARINE



You are assured of uninterrupted operation with all Marine Radio Apparatus. An ironclad, unconditional guarantee absolutely protects you. Literature upon request.

Radio Company

General Offices and Plant
 124-11 101st Avenue
 RICHMOND HILL, NEW YORK

QST

Published monthly, as its official organ, by the American Radio Relay League, Inc., at West Hartford, Conn., U. S. A.; Official Organ of the International Amateur Radio Union

devoted entirely to

AMATEUR RADIO

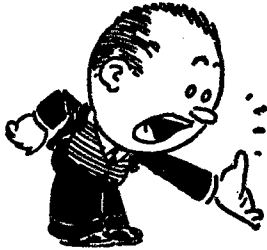

Editorials	9
A.R.R.L. Copying Bee	10
Grunow Competition	10
28-Mc. WAC Accomplished	11
The All-Around 14-Mc. Signal Squirter	M. P. Mims, W5BDB 12
Inexpensive Utility Switchboard Type Racks	C. W. Van Duyne, W3AKT 18
Oscillators Using 14-Mc. Quartz Crystals	J. M. Wolfskill 19
A New Radio Transmission Phenomenon	21
What the League Is Doing	22
Self-Regulating Grid-Bias Supply for Multi-Stage Transmitters	A. W. Friend, W8DSJ 24
Class-B Carrier Control in the Low-Power 'Phone	Henry S. Keen, W2CTK 25
Hamdom	30
A New Receiving System for the Ultra-High Frequencies	Ross A. Hull 31
3500- to 4000-Kc. Transoceanic Tests	38
A.R.R.L. QSL Bureau	39
The Young Squirt's Fourth Epistle to the Old Man	40
Experimenters' Section	
A "FLY-POWER" 'PHONE TRANSMITTER USING A 6A7 — REGENERATIVE AMPLIFICATION AT SIGNAL FREQUENCY — MILLIAMMETER SWITCHING FOR GRID AND PLATE CURRENTS — IMPROVED KEYING-TUBE CIRCUIT — MORE ON SWITCHLESS MONITORING — NOTES ON REGENERATIVE S.S. RECEIVER	41
Amateur Radio Stations	W2CBO, W7BVL, W6GHD 45
Silent Keys	45
With the Affiliated Clubs	46
Calls Heard	47
I.A.R.U. News	49
Operating News	51
Correspondence Department	65
Book Review	72
Kansas State Convention	74
Northwestern Division Convention	76
New Crystal Microphones	78
Mrs. Isabelle W. Moody, W7DHF	82
16th Pacific Division Convention	86
13th Annual Central Division Convention	88
Roanoke Division Convention	90
Standard Frequency Transmissions	94
Missouri State Convention	94
Circulation Statement	98
Power Transformer Design Circular	98
Hamads	115
QST's Index of Advertisers	118

DECEMBER
1935

VOLUME XIX
NUMBER 12

Kenneth B. Warner (Secretary, A.R.R.L.), Editor-in-Chief and Business Manager; Ross A. Hull, Associate Editor; James J. Lamb, Technical Editor; George Grammer, Assistant Technical Editor; Clark C. Rodimon, Managing Editor; David H. Houghton, Circulation Manager; F. Cheyney Beekley, Advertising Manager; Ursula M. Chamberlain, Assistant Advertising Manager.

Editorial and Advertising Offices
38 La Salle Road, West Hartford, Conn.

Subscription rate in United States and Possessions and Canada, \$2.50 per year, postpaid; all other countries, \$3.00 per year, postpaid. Single copies, 25 cents. Foreign remittances should be by international postal or express money order or bank draft negotiable in the U. S. and for an equivalent amount in U. S. funds.

Entered as second-class matter May 29, 1919, at the post office at Hartford, Connecticut, under the Act of March 3, 1879. Acceptance for mailing at special rate of postage provided for in section 1103, Act of October 3, 1917, authorized September 9, 1922. Additional entry at Concord, N. H., authorized February 21, 1929, under the Act of February 28, 1925.

Additional second-class entries to cover sectional editions authorized March 20, 1935

Copyright 1935 by the American Radio Relay League, Inc.
Title registered at United States Patent Office.

We're Overwhelmed—

Here's what they say about the SUPER SKYRIDER—

Marine Radio Co., Richmond Hill, N. Y., says:—
Sure is a honey stop completely sold out even samples stop double our order—

Radio Apparatus Corporation, Newark, N. J., says:—
Our customer's reaction to the appearance resulted in an enthusiasm exceeded only by the performance. We are positive that the Super Skyrider is not only the finest appearing receiver of the season but unquestionably the greatest performer.

Dow Radio Supply Co., Pasadena, Cal., says:—

Just received our order on the new Skyrider, and after a thorough tryout, I am indeed pleased and thrilled at its marvelous performance.

H. Pless Woodward, Statesville, N. C., says:—

I have received the new Skyrider and regard it as the outstanding value in radio today.

Gross Radio, Inc., New York, N. Y., says:—

Just went over your new Super Skyrider and must say I am certainly sold on this job. You seem to have outdone yourself.

Watkins Radio Service, St. Pierre, La.

Received the Super Skyrider today and find it really a masterpiece.



We knew the 1936 Super Skyrider was good, but the avalanche of enthusiastic approval has swept us off our feet. From all parts of the country, from dealers who handle all kinds of receivers and from hams who have used them, we've heard a chorus of unqualified praise and congratulations.

No wonder they're enthusiastic. The Super Skyrider has everything. It's sensitive beyond all practical requirements with its Iron Core I. F. system. The new Metal Tubes eliminate all tube shield noises and increase gain. It's convenient with its modern band changing system—no plug-in coils. A controlled Crystal Filter Circuit gives true one signal selectivity. These are but a few of the exclusive Hallicrafters features that have taken the short wave crowd by storm. You have to see the Super Skyrider to appreciate them all.

In spite of all its advantages and superlative Hallicrafters engineering, the Super Skyrider is extremely moderate in price. You needn't go broke for two years to get this fine short wave receiver. See it today.

McElroy, World's Champion Radio Operator—

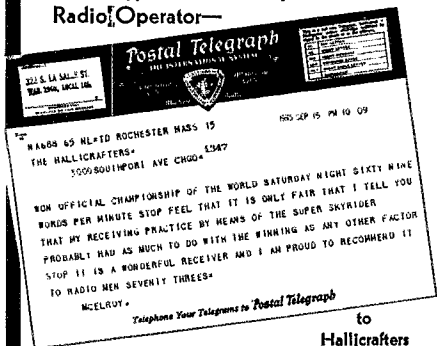

- ★ 9 Metal Tubes—Dovetail perfectly with our efforts to improve signal to noise ratio—eliminate noisy tube shields—reduced inter-electrode capacities and shorter leads afford greater gain.
- ★ Iron Core I. F. system—greatly increased sensitivity and a signal to noise ratio unattainable with an air core system.
- ★ Duo-Micro-Vernier Band Spread—provide improved logging accuracy—provides electrical band spreading and micro-vernier tuning in an exclusive and distinctive dial.
- ★ More efficient Crystal Filter Circuit, controlled by variable knob on front of set gives one signal selectivity—without reducing sensitivity.
- ★ Beat Oscillator with continuous range.
- ★ Modern Band Changing System—any desired bands in the short-wave spectrum with the turn of an exact positive switch—no cumbersome plug-in coils.
- ★ Compact—all completely enclosed in one convenient and efficient cabinet 19 1/4" x 10".

See your dealer today or write for immediate information

the hallicrafters

3001— Southport Avenue, Chicago, Illinois, U. S. A.

Cable Address "LIKEX—New York"

NOW, ON TIME PAYMENTS

the **SUPER SKYRIDER**

the finest short wave receiver we've seen

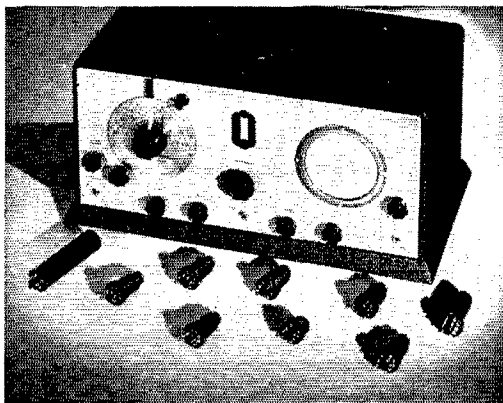

OUR fullest endorsement is behind the amazing new Super Skyrider. We have watched its development, seen it tested, listened to its astonishing performance. Through our close contact with the personnel of the Hallicrafter's organization here in Chicago we are familiar with the skilled engineering that has made this marvelous receiver possible. We can say with authority that the Super Skyrider is today's outstanding short wave receiver.

We like the new Metal Tubes used in the Super Skyrider. They are "right" for short wave receivers with their increased gain and elimination of annoying tube shield noises.

We like the complete arrangement of the Super Skyrider, with *all* the needed equipment in one compact cabinet.

We like the operating convenience provided by this ingenious dial and its handy band switch that does away with all cumbersome plug-in coils.

Above all we like its sensitivity, its ability to get clearly the signal you want.

The Super Skyrider has everything we have always wanted to offer our customers, as complete, as convenient, as efficient a receiver as we have ever seen, priced at only \$79.50 (\$89.50 with crystal filter). Come in and see it today or send in coupon for full details.

MAIL THIS COUPON

HINDS & EDGARTON

19 SO. WELLS STREET
CHICAGO, ILLINOIS

TIME PAYMENTS

Buy your Super Skyrider on Hind & Edgerton's Time Payment Plan — small down payment and easy monthly payments — write at once for details

Gentlemen:

Please send me complete information about the new Hallicrafter Super Skyrider and Hinds & Edgerton time payment plan.

Name _____

Address _____

City _____

OPERATED BY W9APY AND W9WR

GROSS RADIO, INC.

IS HAPPY TO OFFER

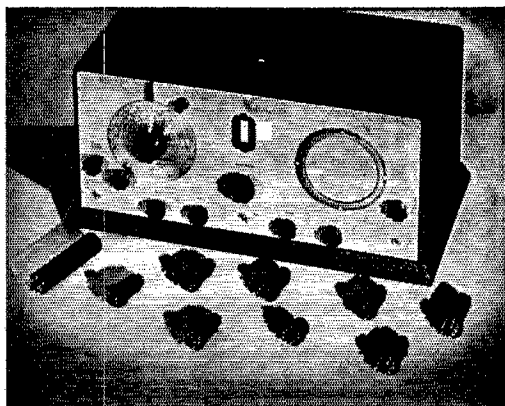

THE HALLICRAFTER SUPER-SKYRIDER

An Outstanding Receiver

Immediate shipment from stock on this and other high grade
amateur equipment

GROSS RADIO, INC., 51 Vesey St., New York City

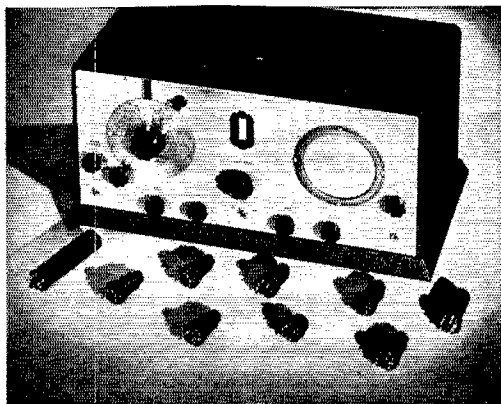

*We recommend the
SUPER SKYRIDER
for its Extreme Sensitivity*

With its Iron Core I.F. system and new high gain Metal Tubes, the Super Sky Rider is years ahead of its field for sensitivity. It's just the thing for the crowded amateurs' bands of today. We heartily endorse this ultra-modern short-wave receiver. Come in to see it or write for literature! List Price \$135.00 — *your price* \$79.50 Net.

THE RADIO SHACK

46 Brattle Street

Boston, Mass.

Lightning Calculators

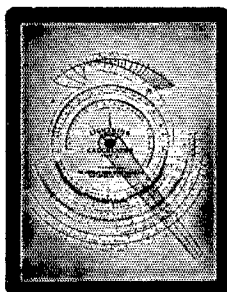

by

A.R.R.L.

THE various LIGHTNING CALCULATORS are ingenious devices for rapid, certain and simple solution of the various mathematical problems which arise in all kinds of radio and allied work. They make it possible to read direct answers without struggling with formulas and computations. They are tremendous time-savers for engineers, servicemen, amateurs and experimenters. They are highly accurate and computations made by them have greater mathematical accuracy than can be measured by ordinary means. Each CALCULATOR has on its reverse side detailed instructions for its use; the greatest mathematical ability required is that of dividing or multiplying simple numbers. You will find LIGHTNING CALCULATORS the most useful gadgets you ever owned.

LIGHTNING RADIO CALCULATOR—Type A (\$1.00) is for solution of problems involving frequency, inductance and capacity, in design of radio frequency circuits from high-powered transmitters to simple receivers. Gives direct reading answers for size of coils and condensers for any frequency or range between 400 kc. and 150 mc.

LIGHTNING OHMS LAW CALCULATOR — Type B (\$1.00). Gives direct reading answers to calculations involving current, resistance, voltage and power with scale for resistance of copper wire and additional supplemental scale for calculating decibel gain or loss. Answers three separate kinds of problems: Finding value of current, voltage, power or resistance, when any two are known; finding resistance or voltage drop in any wire or circuit or resistor; finding decibel gain or loss in amplifiers or circuits. Answers accurate within commercial tolerances.

LIGHTNING WIRE DATA CALCULATOR — Type C (50c). Puts at your fingertips more information on electrical conductors than you could find in a book full of tables: Such as resistance per foot, per mile, per meter, pounds per foot, per ohm, miles per thousand ohms, current carrying capacity, turns per inch, turns per square inch, diameter in mills for all B. & S. and Stubbs gauges, for all kinds of wire such as copper, aluminum, nichrome, manganin, etc.

LIGHTNING DECIBEL CALCULATOR — Type D (50c). Gives direct reading answers in decibel gain or loss in four kinds of problems: When input and output voltages are known; when input and output currents are known; when input and output power are known; when input voltage to the receiver and assumed output level are known.

LIGHTNING PARALLEL RESISTANCE — SERIES CAPACITY CALCULATOR — Type E (50c). Gives direct reading answers for total resistance of two or more resistors connected in parallel; and gives direct reading answers for total capacity of two or more condensers connected in series.

LIGHTNING RESISTANCE CALCULATOR — Type F (50c). Permits measurement of any resistor, from 1 ohm to 1 megohm by use of any voltmeter and any voltage source. Makes an ohm-meter of your voltmeter.

Postpaid from

**AMERICAN RADIO RELAY LEAGUE
WEST HARTFORD, CONNECTICUT**

Section Communications Managers of the A.R.R.L. Communications Department

All appointments in the League's field organization are made by the proper S.C.M., elected by members in each Section listed. Mail your S.C.M. (on the 16th of each month) a postal covering your radio activities for the previous 30 days. Tell him your DX, plans for experimenting, results in 'phone and traffic. He is interested, whether you are an A.R.R.L. member or get your QST at the newsstands; he wants a report from every active ham. If interested and qualified for O.R.S., O.P.S. or other appointments he can tell you about them, too.

Eastern Pennsylvania Maryland-Delaware-District of Columbia	W3EZ W3BAK W3ZY W8DSP W8CUG	ATLANTIC DIVISION James M. Bruning	339 W. Lancaster Ave.	Haverford
Southern New Jersey Western New York Western Pennsylvania		Edgar L. Hudson Arthur L. Kentner Don Farrell C. H. Grossarth	1107 Park Ave. 213 Hickok Ave. 261 N. Balph Ave.	Laurel, Delaware Collingswood Syracuse Bellevue
Illinois Indiana Kentucky Michigan Ohio Wisconsin*	W9WR W9TE W9AUH W8DYH W8CIO W9ATO	CENTRAL DIVISION Fred J. Hinds	6618 West 34th St. 5211 Brookville Rd. Box 177	Berwyn Indianapolis Camp Taylor Detroit Cleveland Milwaukee
North Dakota South Dakota Northern Minnesota* Southern Minnesota	W9OEL W9PFI W9JIE W9DEI	DAKOTA DIVISION Hartwell B. Burner Mike G. Strahon R. C. Harshberger Francis C. Kramer	601 S. Grange Ave. 1200 Fauquier St. W. Bluff St.	Hone Sioux Falls St. Paul, Minnesota St. Charles
Arkansas Louisiana Mississippi Tennessee	W5ABI W5DWW W5CWO W4BBT	DELTA DIVISION H. E. Vette W. J. Wilkinson, Jr. J. H. Weems, Jr. Merrill B. Parker, Jr.	2918 West 15th St. 1523 Laurel St. P. O. Box 244 1912 Oak St.	Little Rock Shreveport State College Chattanooga
Eastern New York N. Y. C. & Long Island Northern New Jersey	W2LU W2AZV W2FOP	HUDSON DIVISION Robert E. Haight E. L. Baunach Charles J. Hammersen	511 South Holmes St. 7823 10th Ave. 92 Claremont Ave.	Scotia Brooklyn Verona
Iowa Kansas Missouri Nebraska	W9LEZ W9FLG W9CJR W9FAM	MIDWEST DIVISION Ihrl D. Boardman O. J. Spettar J. Dewey Mills Samuel C. Wallace	325 Kirkwood Blvd. 305 Western Ave. Box 205 Green St.	Davenport Pepeka Mount Vernon Clarke
Connecticut Maine Eastern Massachusetts Western Massachusetts New Hampshire Rhode Island Vermont	W1CTI W1CDX W1ABG W1BVR W1AVJ W1HRC W1BJP	NEW ENGLAND DIVISION Frederick Ellis, Jr. John W. Singleton Albert N. Giddis Percy C. Noble Robert Byron Clayton C. Gordon Forrest D. Drew	19 Merrill Rd. 73 Allen St. 128 Crawford St. 37 Broad St. 12 Humphrey St. 206 California Ave. 947 E. Main St.	Norwalk Wilton Lowell Westfield Concord Providence Newport
Alaska Idaho Montana Oregon Washington	K7PQ W7NH W7AAT W7AMF W7LD	NORTHWESTERN DIVISION Richard J. Fox Nellie H. Hart O. W. Viers Frank L. Black Niilo E. Koski	Box 301 Box 6 Box 265 1502 McPherson St. 3822 E. Green Lake Way	Ketchikan Twin Falls Red Lodge North Bend Seattle
Hawaii Nevada Santa Clara Valley East Bay San Francisco Sacramento Valley Philippines San Joaquin Valley	K6EWQ W6BIC W6BMW W6JTV W6SG W6DVE KA1XA W6CRF	PACIFIC DIVISION Atlas O. Adams Edward W. Heim Charles J. Camp Harold J. Burchfield Alan D. Whittaker, Jr. Geo. L. Woodington Newton E. Thompson Vernon C. Edgar	21st Infantry Brigade 716 West Sixth St. 318 Hawthorne Ave. 2940 106th Ave. 79 Elinor Ave. 716 Redwood Ave. P. O. Box 849 732 Blackstone Ave.	Schofield Barracks Reno Palo Alto Oakland Mill Valley North Sacramento Manila, P. I. Fresno
North Carolina Virginia West Virginia	W4OG W3BRY W8KKG	ROANOKE DIVISION H. S. Carter Neil E. Henry Dr. Wm. H. Riheldaffer	115 Crafton St. 1017 Knight St.	Winston-Salem Lynchburg Lost Creek
Colorado Utah-Wyoming	W9FA W6GQC	ROCKY MOUNTAIN DIVISION Glen Glascock Arty W. Clark	1171 Detroit St. 260 So. 9th West	Denver Salt Lake City, Utah
Alabama* Eastern Florida Western Florida Georgia-So. Carolina-Cuba- Isle-of-Pines-Porto Rico- Virgin Islands	W4DS W4BCZ W4MS W4CE	SOUTHEASTERN DIVISION J. Wesley Davis Philip A. McMasters Edward J. Collins Bannie L. Stewart	835 Young St. 731 Arlington Ave. 1517 East Brainard St. SC-P53. C.C.C. Camp Lawrence	Selma St. Petersburg Pensacola Effingham, S. C.
Los Angeles Arizona San Diego	W6BPU W6LVG W6EOP	SOUTHWESTERN DIVISION Howell C. Brown C. C. Day Harry A. Ambler	120 N. El Molino Ave. "La Posta Quemada" 4101 Hamilton St.	Pasadena Vail San Diego
Northern Texas Oklahoma Southern Texas New Mexico	W5BII W5CEZ W5ADZ W5CGJ	WEST GULF DIVISION Richard M. Cobb Carter L. Simpson Bradfield A. Beard Joseph M. Eldodt	Box 185 2010 So. 4th St. 2030 Quenby Road	Dodd City Ponca City Houston Chamita
Maritime	VE1DQ	MARITIME DIVISION A. M. Crowell	69 Dublin St.	Halifax, N. S.
Ontario*	VE3JT	ONTARIO DIVISION F. W. Hartley	63 Bellwoods Ave.	Toronto 3
Quebec	VE2EE	QUEBEC DIVISION Stan Comach	780 Brault Ave.	Verdun, P. Q.
Alberta British Columbia*	VE4GD VE5EP	VANALTA DIVISION J. Smalley, Jr. D. R. Vaughn-Smith	611 1st Ave., N. W. 1221 Burnaby St.	Calgary Vancouver
Manitoba Saskatchewan	VE4BG VE4EL	PRAIRIE DIVISION A. J. R. Simpson Wilfred Skaife	71 Thelmo Mansions 2040 McTavish St.	Winnipeg Regina

* Officials appointed to act until the membership of the Section choose permanent S.C.M.'s by nomination and election.

The American Radio Relay League



• **T**HE AMERICAN RADIO RELAY LEAGUE, INC., is a non-commercial association of radio amateurs, bonded for the promotion of interest in amateur radio communication and experimentation, for the relaying of messages by radio, for the advancement of the radio art and of the public welfare, for the representation of the radio amateur in legislative matters, and for the maintenance of fraternalism and a high standard of conduct.

It is an incorporated association without capital stock, chartered under the laws of Connecticut. Its affairs are governed by a Board of Directors, elected every two years by the general membership. The officers are elected or appointed by the Directors. The League is non-commercial and no one commercially engaged in the manufacture, sale or rental of radio apparatus is eligible to membership on its board.

"Of, by and for the amateur," it numbers within its ranks practically every worth-while amateur in the nation and has a history of glorious achievement as the standard-bearer in amateur affairs.

Inquiries regarding membership are solicited. A bona fide interest in amateur radio is the only essential qualification; ownership of a transmitting station and knowledge of the code are not prerequisite. Correspondence should be addressed to the Secretary.

DIRECTORS

<i>President</i>	
HIRAM PERCY MAXIM.....	W1AW Box 216, Hartford, Conn.
<i>Vice-President</i>	
CHARLES H. STEWART.....	W3ZS St. David's, Pa.
<i>Canadian General Manager</i>	
ALEX REID.....	VE2BE 169 Logan Ave., St. Lambert, P. Q.
<i>Atlantic Division</i>	
EUGENE C. WOODRUFF.....	W8CMP 234 W. Fairmount Ave., State College, Pa.
<i>Central Division</i>	
EDWARD A. ROBERTS.....	W8HC 2699 Endicott Rd., Shaker Heights, Cleveland
<i>Dakota Division</i>	
CARL L. JABS.....	W9BVH 1822 James St., St. Paul, Minn.
<i>Delta Division</i>	
M. M. HILL.....	W5EB P. O. Box 14, Natchitoches, La.
<i>Hudson Division</i>	
KENNETH T. HILL.....	W2AHC 115 Willow St., Douglaston, L. I., N. Y.
<i>Midwest Division</i>	
H. W. KERR.....	W9DZW-W9GP Little Sioux, Iowa
<i>New England Division</i>	
G. W. BAILEY.....	W1KH 74 Webster Road, Weston, Mass.
<i>Northwestern Division</i>	
RALPH J. GIBBONS.....	W7KV 3933 N. E. 70th Ave., Portland, Ore.
<i>Pacific Division</i>	
S. G. CULVER.....	W6AN 2962 Russell St., Berkeley, Calif.
<i>Roanoke Division</i>	
H. L. CAVENESS.....	W4DW State College Station, Raleigh, N. C.
<i>Rocky Mountain Division</i>	
RUSSELL J. ANDREWS.....	W9AAB 1867 So. Lafayette St., Denver, Colo.
<i>Southeastern Division</i>	
BENNETT R. ADAMS, JR.....	W4APU 1512 Grove Place, Homewood, Ala.
<i>West Gulf Division</i>	
WAYLAND M. GROVES.....	W5NW c/o Humble Pipe Line Co., Neches, Texas

OFFICERS

<i>President</i>	HIRAM PERCY MAXIM, W1AW Hartford, Connecticut
<i>Vice-President</i>	CHARLES H. STEWART, W3ZS St. David's, Pennsylvania
<i>Secretary</i>	KENNETH B. WARNER, W1EH West Hartford, Connecticut
<i>Treasurer</i>	ARTHUR A. HEBERT, W1ES West Hartford, Connecticut
<i>Communications Mgr.</i> ...	F. EDWARD HANDY, W1BDI West Hartford, Connecticut
<i>General Counsel</i>	PAUL M. SEGAL, W3EEA 1010 Shoreham Building, Washington, D. C.

Address all general correspondence to the executive headquarters at West Hartford, Connecticut



THE EDITOR'S MILL

WE WONDER if we are paying sufficient attention to the language of the F.C.C.'s new Rule 381. This rule has introduced a new concept into amateur regulation. In the early days of radio we used to feel that even if our signals did possess clicks and hum and great breadth and all manner of spurious products, it was nobody else's worry so long as the entire effect fell within an amateur band. The same attitude was observed towards harmonics, and in fact the original partitioning of the high-frequency spectrum into bands roughly an octave apart was not done so much for convenience in doubling from band to band as it was to insure that harmonics would fall in the same service; one of the maxims of allocation engineering in those days was "Every Service Eats Its Own Hash." (One can imagine how far back that was by noting that it was even harmonics which were then most troublesome.)

In the days when it was a struggle to make apparatus perform properly, it was well enough to have this easy-going idea that any calibre of signal was satisfactory if only it stayed within an amateur band. But we have long since outgrown that notion. There are too many of us and our bands are too crowded. Moreover, there is no longer any reasonable excuse for it, so improved are both our apparatus and our technique. This new regulation in effect says that no amateur signal shall now be permitted to cause any interference outside of that narrow group of frequencies which are normally required for the signal and its modulation by either voice or key—the rule applies equally to c.w. stations and 'phone stations. The selfish signal remains our greatest problem, both in c.w. and in 'phone work, and a much greater problem than the interference caused by sheer pressure of numbers, for a single bad signal can wipe out half the band on thousands of tuners. The selfish signal is no longer legal if only it keeps all its whiskers tucked inside the amateur vest. It is now definitely contrary to regulations and it is more important than ever that each amateur make it his concern to see that he has a respectable and decent signal.

The new regulation in so many words prohibits the excessive modulation of 'phone stations—which is probably the most serious form of selfish signal. The seven monitoring stations of the F.C.C. have gone to work on this new job, and already a stream of citations is pouring forth on the little colored slips already so familiar to us for out-of-band-operation or for operating with inadequately-filtered supply. On a recent visit to Washington we had an opportunity to inspect some of these citations as they flowed through the F.C.C. mill. Some of them stated that the station observed had been employing modulation greatly over 100%, that it also had a very bad audio quality, and that its signal was very broad. When it is considered that the monitoring stations at present are making these citations only after two or more observations of the same signal, and that they are concentrating upon the signals that are greatly and palpably overmodulated, and that they cite only after making due allowance for fading effects, it is borne in upon one that these must be terribly bad signals indeed and that there is little room for anyone to object. It is up to the 'phone men, no less than to the c.w. men, to give their signals a shave and trim off the whiskers. It is much easier to do this for the sake of pride in a good signal than it is in response to an F.C.C. citation. At the very least, the latter involves the annoyance of explaining the situation and making a showing of steps taken to correct it. For a second citation for the same offense, the station is put off the air during the desirable operating hours, until tests made with two other amateurs certify to the correcting of the trouble; and for a third offense the station is put off the air altogether until it can arrange for a special test with one of the monitoring stations. This is not the grim hand of an unkindly government. It is a simple police system at work in our own interests. We trust that all 'phone men realize that the compulsory control of overmodulation will produce a farther-reaching improvement in 'phone operating than any other single step that could be taken.

K. B. W.

A.R.R.L. Copying Bee—December 27th



JUST for some good fun, and to give hams opportunity to try their hand at copying some unusual word combinations, figure groups, and simple punctuation, an annual "copying bee" is scheduled. There may be trick words, or even misspelled words, words sent in no particular sequence. The transmissions will be between 50 and 100 words in length. The sending will be by tape at about 20 to 25 words per minute. It will be a test to *copy what you hear*.

Transmissions will be made by high-power amateur stations, all using "automatic" equipment. Stations in each time zone will transmit different text. Great care will be taken to make all messages equally difficult. Intentional errors will be inserted; different errors, different words, different word order. It will be worse than useless to try to correct or compare messages. Possibly no one will make perfect "copy." We urge everybody who knows the code *at all* to take part and *send in whatever they get*. It will be interesting to see how we all fare in the copying bee. A full report will be given in *QST*.

The schedule of transmissions for Friday night, December 27th, is as follows:

Station	Frequency	E.S.T.	C.S.T.	P.S.T.
W1MK (Hartford)	3825/7150 kcs.	9:15 p.m.	8:15 p.m.	6:15 p.m.
W2AYN (New York)	7290 kcs.	9:15 p.m.	8:15 p.m.	6:15 p.m.
W9UZ (Chicago)	7003 kcs.	10:15 p.m.	9:15 p.m.	7:15 p.m.
W9ABU (Chicago)	3546 kcs.	10:15 p.m.	9:15 p.m.	7:15 p.m.
W6ZF (San Francisco)	7053.8 kcs.	11:15 p.m.	10:15 p.m.	8:15 p.m.
W6AM (Long Beach)	3720 kcs.	11:15 p.m.	10:15 p.m.	8:15 p.m.

The rules for taking part in the copying bee are very simple.

(1) Any amateur operator, not having access to the tape or transmission copies and copying wholly by ear is eligible.

(2) Only one copy shall count. Mark the *one* copy which you are submitting as your "best."

(3) It is not necessary to submit more than one copy . . . but please report all the above stations heard.

(4) Send in *original* copies. Re-copying messages invariably introduces errors and detracts from credits.

(5) Copies must be mailed within ten days of December 27th to be counted.

A silver loving cup has been selected as a trophy to be presented to the winner of the copying bee. In addition to the cup, a winner in each A.R.R.L. Section will be selected. Full report will appear in *QST*.

The stations will each send V's with frequent identification by call signal, for at least ten minutes before the scheduled transmission time. All amateurs are requested to note the frequencies listed and endeavor to cooperate by keeping silence on these and closely adjacent channels during the transmission of the copying bee material, which will start at the time indicated. All set? Remember, *copy what you hear*. Even if you get only part of a transmission, *send it in* so we can credit you for what you get. Best luck in the copying bee.

— F. E. H.

Strays

Please!

Every magazine publisher finds the change-of-address problem a difficult one. By necessity wrappers are prepared well in advance of actual date of mailing of each issue. Prompt advice of your new address, giving your old one at the same time, will be appreciated. Thank you!

We stand corrected. The two fellows who have the calls W6GIN and W6FIZ (see page 52, October *QST*) are one and the same person. Not a bad pair of calls for one ham!

----- Grunow Competition

The Grunow ultra-high frequency competition, announced in March, 1935, *QST*, has been declared "no competition" by the judges, under Rule 6.

28-Mc. WAC Accomplished

W3FAR, ZS1H and W7AMX Work All Continents—Other WAC's Rumored

OCTOBER, 1935, will go down in amateur history as a month of unprecedented activity and unusually good DX conditions on ten meters. There were times, in fact, especially on week-ends, when one had to look twice to make sure that the right coils were in the receiver—"ten" sounded just about like "twenty" does when DX is at its best! All the old familiar DX calls were there—and often with louder signals than they ever put across on 14 mc.

At the last minute we managed to squeeze word in November *QST* that ZS1H had worked all continents on 28 mc. Later information indicates that the first man actually to complete WAC was W3FAR, who worked J2CL at 5:40 p.m. E.S.T., October 12th, for his sixth continent—just about nine hours before ZS1H contacted J2HJ for his WAC! W7AMX worked G2PL on the 23rd for his sixth continent, according to a radioed report from G2PL via W2DTB. No other U. S. stations have reported working all continents to date, although many need only one continent. We have been informed indirectly that G2YL, OK1AW, and D4ARR also have worked all continents; no confirmation as yet, however. W8CRA is not sure whether he made it or not, as auto QRM drowned out the J he was calling just when CRA thought he had him hooked!

Toward the end of September signals from South America and Australia were being heard in this country with fair regularity, along with South Africa. About the first week in October a few Europeans started filtering through; their signals rapidly built up to a peak inside a period of a few days. R8 and R9 European sigs were the rule for about two weeks on the East Coast; toward the latter part of the month, however, conditions have taken a drop and although Europeans are still being heard their signals are weaker and fewer stations are getting through. For a time the West Coast fellows seemed to be shut out on the European stuff, but toward the latter part of the month several W6's had snagged G's and D's.

So many American stations have been working Europe and Africa that a complete account of what has been going on would fill several pages. The calls heard lists appended to this screed will

give some idea of the activity that has been taking place.

W3FAR's work was done with a pair of 10's in push-pull, using an input of only 22 watts. Five of the six continents were worked on 'phone as well as c.w., using a pair of 46's as Class-B modulators. The ten-meter band thus lives up to its reputation of giving real DX with low power. The antenna used is an 80-meter Zepp with 33-foot feeders, the flat-top being about 30-feet off the ground. The station is owned by John J. Michaels, transmitter chief at KYW, and is located at North Wales, Pa., about 25 miles northwest of Philadelphia. Michaels is a real old-timer, having got on the air back in 1912 under the call 9MC in

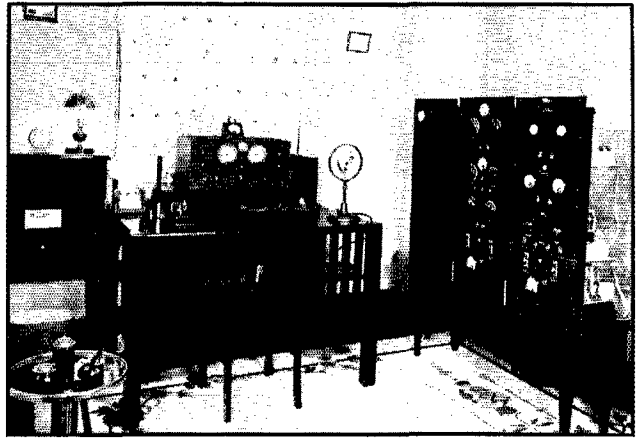

W3FAR—FIRST STATION TO WORK ALL CONTINENTS ON TEN METERS

A crystal-controlled rig using a pair of 10's in push-pull in the final stage. Input runs between 20 and 25 watts on 28 mc., and about 30 watts on 14 mc. WAC also has been made on the latter band. The right-hand relay rack contains the audio equipment and power supplies, using two 56's in the speech amplifier, a 59 driver and pair of 46's Class-B in the modulator. The middle rack houses the r.f. end with its power supplies. The line-up is a 47 crystal oscillator, three 46 doublers, and the 10's. The third rack contains antenna tuning and matching equipment. The receiver is an RME9D with 28-mc. coverage.

Chicago; post-war 9RP, cancelled when KYW was moved from Chicago to Philadelphia. He says North Wales is a ham's paradise for reception (and we won't argue with him on it!).

Most W hams agree that the most consistent DX signal is that from ZS1H, the station of G. A. Shoyer of Rondebosch, near Cape Town, South Africa. ZS1H has been putting R7 to R9 signals into West Hartford practically every day during October, and his reports from other parts of the country are just as consistent. He has worked all

(Continued on page 106)

The All-Around 14-Mc. Signal Squirter

Details of a Compact Remote-Control Directional System for Small Space

By M. P. Mims,* W5BDB

ANTEENNA-ITIS is a disease of very common occurrence among the brethren of the amateur fraternity which is taken seriously all too infrequently. The patient shows high temperatures, wanders around aimlessly looking over each and every extension toward the heavens above—the higher the better. Then, too, he always comes to the aid of another ham who has taken to climbing and tries to help Professor Darwin prove out his theory of relativity—principally to the monkey. Incidentally, we have felt that the appending tail Mr. Monk uses so glibly in swinging through the tree tops might be borrowed occasionally. What a help it could be in stringing sky wires.

Having partially recovered, we hope, from quite an extensive attack of the aforesaid malady, it might be just as well that we jot down a few lines for the aid of these who may feel the onslaught of a similar attack. It caught us all unawares. An idea slipped up on us—the same old idea that worries all of us everywhere; the desire to put a signal where we wanted it when we wanted it was the sum total of the order. Roy Hunt out at W6CNE had just pulled through a very bad spell and survived with what seemed like permanent inoculation. Along with many others we had spent considerable time checking and reporting to Roy on his developments; and so came the final decision to start a few checks going in our own backyard.

Even though we live in the "Wilds of Arkansas," we have only a small amount of space in which to erect the skywire. Multi-wave, "V", diamond, phased elements—all of those were out of the realm of possibility. Anyway, they wouldn't do what we were wanting. The half-wave with its "Q" feed system was doing a good job—in its favorable directions; but we were not able to raise some of the odd spots we hoped we could reach if the antenna could only remain good for the directions it was already working and be made equally as good in the others.

Since the antenna had to be small, there was but one thing to do and that was to use rotation. At the same time we had the usual desire for greater efficiency from the antenna. Since it would be rotated, why not make it as much of a uni-directional system as possible and put our best foot forward in the single lobe? The result was the

selection of a single half-wave radiator backed up by a similar reflector spaced approximately a quarter-wave. Field strength patterns for various combinations of spacing, phasing and number of elements were found in an article by Southworth¹ and proved most useful in our experimentation.

POINTERS ON REFLECTOR SYSTEMS

It is not the intention of this article to cover the theory upon which the system used is based; but it might be well to touch lightly on a few points worthy of consideration. First of all, why use a reflector? Two reasons are more than sufficient to justify the addition to the extra element. First, theory predicts and practice proves a reasonable gain in signal strength in the desired direction as shown in Fig. 1. The increase is theoretically about 2.7 db; or, expressed in terms of power gain, a step-up in effective power of about 75%. In other words, a 120-watt transmitter used in conjunction with this system gives an effective carrier in the desired direction of two hundred watts; or, another example, the ordinary rig using a 100-watt bottle in the final does about the same job as a pair of the same tubes will do on the conventional antenna; and the expense is far less.

The second reason, though far less spectacular, is of even greater importance in the long run, especially should the idea become of rather general use. Fig. 2 gives us a nice key to reduction of interference on our all too narrow and crowded bands, whether 'phone or c.w. Not only is it true in transmission that we concentrate our signal in the desired direction with an increase in strength at that point, but also that we obtain a consequent decrease at other points of the compass. This is an actual plotted response on a receiver as the antenna was rotated through the full circle on a given transmitting station. We find that the incoming signal is received best when off the broadside of the antenna and weakest when off the ends of the array with some reduction when off the reflector. Quite frequently the shifting of the antenna direction so as to reduce an interfering signal only one or two R's has been sufficient to allow us to carry through a 100% QSO which was entirely impossible using an ordinary half-wave doublet a full-wave off ground. In cases where we were contacting a station to the west with strong interference from the north, the two

* P. O. Box 504, Texarkana, Ark.

¹ *Proceedings of I.R.E.*, Sept., 1930.

stations being of equal strength, the QSO was impossible when both were on the air on a regular doublet; while on the "Signal Squirrel" the station to the north was reduced from an R9 down to an R3 or 4, and the desired station to the west was brought in at a slightly higher strength than on the straight antenna.

Thus we find a double use for the Signal Squirrel; first, a concentration of transmitted energy in the desired direction with an average increase of about one R point, and at the same time a decrease of interference produced in other directions; second, a corresponding improvement when the same system is used for receiving, as shown in Fig. 2. Increased signals at both ends with the Signal Squirrel used at only one end really gives added effective selectivity. Results in actual operation over a period of a couple of months indicate that our signals are of appreciably greater strength over about 120 degrees of the circle on transmission, and that about the same thing applies equally to received signals, though the two patterns are quite different in form, which is as it should be. It is further realized that greater gain in transmission as well as receiver selectivity could be obtained by the use of more complex arrays; but once again we come back to the point of practical application. At present we are not able to visualize a satisfactory array of greater gain than this which can be controlled at will with the push of a button or the twist of a crank. Our experience has indicated that the results with the present unit are so far ahead of common practice as to justify the expense and effort required in its construction.

DEVELOPING THE "SQUIRTER"

After much planning, drawing and figuring with materials obtainable on the local markets, it appeared that we could do a pretty good job of the thing; so we started to work building up a rotating element to carry the antenna and reflector. Plenty of work on nice warm June evenings finally brought out a unit that looked pretty good—until we tried to put the elements on the frame. Then things started happening plenty fast. One corner was up and the other down. The spacing good here and hard to hold there. Angles? Boy, we had plenty of them!

After sitting down and blowing off the surplus steam, we decided to stop, look and listen to see what might be done with another plot. Two or three days and nights of heavy drain on the old 66's in the top story produced another scheme. More evenings of hard work in hot weather finally brought the second one to its end—the junk pile.

Need we go through the next two attempts? Four times at bat without even a foul ball to our credit. This desire to put signals where desired was proving a real pain in the neck and a strain on the pocketbook. But we were pig-headed enough to think we had a decent idea basically and to believe we still could yet get the unit we wanted.

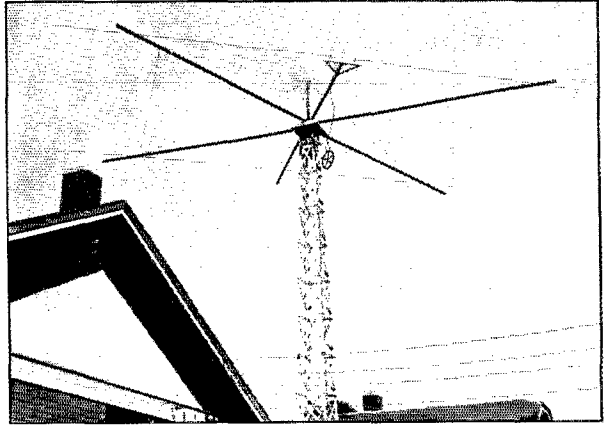

THE ROTATABLE 14-MC. SIGNAL SQUIRTER MOUNTED ON ITS 31-FOOT LATTICE TOWER IS CONTROLLED FROM A CRANK RIGHT AT THE OPERATING POSITION IN THE SHACK. IT NOT ONLY GIVES REAL GAIN IN TRANSMISSION BUT ALSO LESSENS INTERFERENCE CORRESPONDINGLY WHEN USED FOR RECEPTION

Number five checked out pretty well. There were a number of things that had to be corrected and shaped up better, although it was in line with what we were hunting. But it was torn down and its successor, chapter six, was sufficiently decent in appearance to justify its right to sit on top of the thirty-one-foot tower and have its chance to chase a few signals out over the pea patch. So, on a nice warm Sunday morning, three of us put it on top of the tower, ran the twisted-pair feeders in to the shack and coupled it to the transmitter. A CQ was turned loose with the antenna pointing to the north-east. Did we feel good when W9ARK came back with a call and a nice report? Don't ask such foolish questions. While transmitting, "Joe the Bullherder" was outside and still wondering if the thing really was directional. Without warning, he gradually "swang" the unit away from the NE position around toward the west. A standby on the transmission brought forth strenuous complaints that the signal was way down and interference covering us up very badly. A few more checks with this station and the needle on his receiver did the big dip each time the antenna was turned from his direction.

Check after check in the weeks following brought the same results, almost without fail. Occasional checks had us confused at times. Finally, it worked out that transmissions to points within a thousand-mile radius usually brought a report of a rear lobe as well as the front,

though the rear one was quite narrow and weaker. This finally was determined to be a failure of the reflector to cancel out the higher-angle radiation. On these close-in points we also found that the signal off the ends of the assembly was cancelled out to a greater proportion than on contacts over greater distances. This had to be accepted because there was no feasible method of controlling it. Besides, the contacts over short distances are rather rare and so enjoyable when they do come through that we are glad to have the extra chance at the boys close in. Originally, we had planned to put the unit up on the tower and go to work with the field-strength meter and try to have the assembly in good efficient shape before making use of it on the air; but we had had other original ideas that didn't pan out, so to make it unanimous we went ahead and used the rig on the air as it was put up, without final adjustment, for some little time just to see what it would do in the way of working out. The final adjustment tests came later.

THE FINAL ROTATING UNIT

Passing over structural details of the earlier attempts, we will describe the seventh unit as it

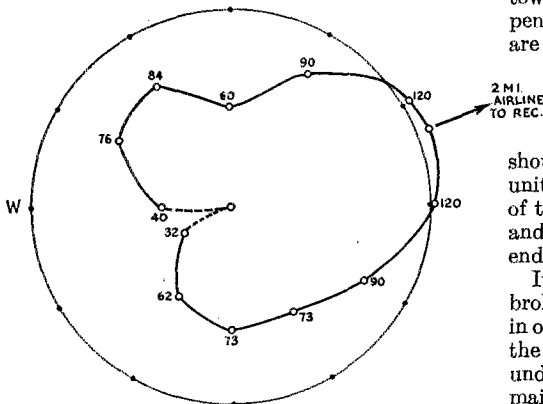

FIG. 1.—FIELD STRENGTH PATTERN FOR COMPLETE ROTATION OF ANTENNA

Measurements made at airport two miles distant airline and well in open using carrier amplitude meter readings of RME9D receiver. All values in times stronger than input required for R1 signal indication, a very short piece of wire being used for antenna on receiver. This pattern is not only close to theoretical but also is quite in line with results of contacts over a period of two months. An R9 signal report off front will drop to R5 off ends and very low off back of assembly at distances greater than 1000 miles.

was rebuilt from the sixth after a couple of months use. The picture and diagrams reproduced herewith will in all probability give the reader a better idea of the method used in building than elaborate attempts to do it with words; but a few points should be called to attention and the picture thus clarified.

As shown in Fig. 3, the center member of the

top structure is the heart of the whole rigging. A base plate of No. 10 gauge sheet iron 20 by 22 inches has a steel tube of 1½-inch diameter welded to it and extending 3½ feet up. Four ¼-inch iron rods are used as braces to maintain the upright tube true and are welded to the tube and base plate. These rods are placed so as not to interfere with the supporting arms for the antenna and reflector. As shown in Fig. 4, these supporting arms are made of 2-inch by 2-inch selected straight-grain yellow pine treated with three good coats of shellac to prevent weathering of the wood and to provide further insulation, three pieces being used on each side, one set for the antenna and the other for the reflector. Guy wires are run from the top of the steel tube, as indicated in the drawings, to support the members. Guy wires are also run as indicated in Fig. 4 to keep the various supporting arms in their relative positions. Suitable bolts and fittings are used to fasten the arms to the base plate at the center. The guy wires from the top of the center member to the six supporting arms for the elements have two-inch take-up turnbuckles in them and all of these turnbuckles are mounted at the top of the assembly where they may be reached from the tower to allow any needed take up or slack compensation with the passing of time. Turnbuckles are likewise provided in the guy wires from the front supporting section to the rear supporting section. These of necessity had to be placed where they could not be adjusted from the center. Hence, this adjustment should be made very carefully before erecting the unit. It will hold in fine shape over a long period of time. The spacing guys used across the front and rear sections are permanently set before the end spacers are adjusted.

It is quite necessary that these guy wires all be broken into lengths of less than one-eighth wave in order that there be no chance of their distorting the pattern and producing spurious lobes at undesired points, as well as detracting from the main frontal lobe. Some fear was felt at first that the center member, being located exactly one-eighth wave back from the antenna, might have some effect on the pattern; but by keeping the dimensions below the lengths that could possibly oscillate at the transmitting frequency, this was entirely eliminated. After the entire unit was up and in operation, careful checks were made with neon bulbs and a thermocouple galvanometer to be sure there were no oscillating guy wires or other metal parts in the entire assembly. Field strength patterns later confirmed our hopes that there was no serious electrical effect from the metal in the field of the antenna.

THE ROTATING MECHANISM

The mechanical strength of the assembly described is quite beyond what we had expected and is really every bit that is needed. Before

proceeding to the actual mounting of the antenna and reflector on the assembly, we will drop back to the center member and see how it is to be held up in the sky and what mechanism is to make it turn—and turn easily. This was a problem which brought about considerable hard thinking and much planning. The first system tried for rotation was a large pulley made of wood and tempered Masonite which had a rope fastened around it for a couple of turns and tied down at the center. The unit was then rotated by the pull on one end of the rope or the other. After discarding numerous types of bearings for the unit to turn on, it was decided to use some special casters having large steel balls in place of the customary wheels. These casters were counter-sunk into the platform which had been made of good strong 2-inch material, well cross-braced and firmly mounted on top of the tower. They furnish a wonderful bearing for the assembly to turn on and offer little resistance to the rotary motion needed. They prove to be all that is desired.

How is the unit kept on top of the tower and not let roll off to one side or the other the first time a bit of pressure is applied or a breeze happens to blow? A hole $1\frac{3}{8}$ inches in diameter was drilled through the center of the top platform before the unit was mounted. After it was on top and in place, a smaller tube was slipped up through the bottom side of the platform into the tube forming the center of the unit. This smaller tube telescoped into the larger one with a nice fit and when fastened down below held the top in position nicely and at the same time allowed free turning.

After the large wooden pulley mounted on the underneath side of the top center structure was found unsuitable as the means of rotation, it was decided that there should be a worm driven gear on the lower end of the smaller tube which serves as an axle for the unit. A concern handling such material was able to furnish the needed unit. We mounted this on a sub-platform down inside the tower about two feet, and fastened the drive tube to the axis tube of the rotating assembly. A nickel-steel bolt through both tubes above the metal base transferred the drive to the unit. This unit is very easy to turn from the worm side of the gear but holds the Signal Squirter in any position very firmly.

The shaft of the worm gear extends outside the tower and a light-weight grooved iron pulley of 12-inch diameter is mounted on it there. A weather-proofed rope belt of small size runs over this pulley and extends to the wall of the shack, along through idling pulleys to a point outside the operating position where another pulley of similar construction to the one on the worm gear shaft but of about 6-inch diameter is mounted on a shaft extending through the wall to the operating position in the station. A crank on the other end

of this shaft provides an easy means of rotating the Signal Squirter while on the air and as desired.

The crank business is very good but the dictates of fancy and a bit of laziness have brought the desire for "push-button" control. This matter is almost solved at the moment and about ready to put into use. Also has come the desire for an

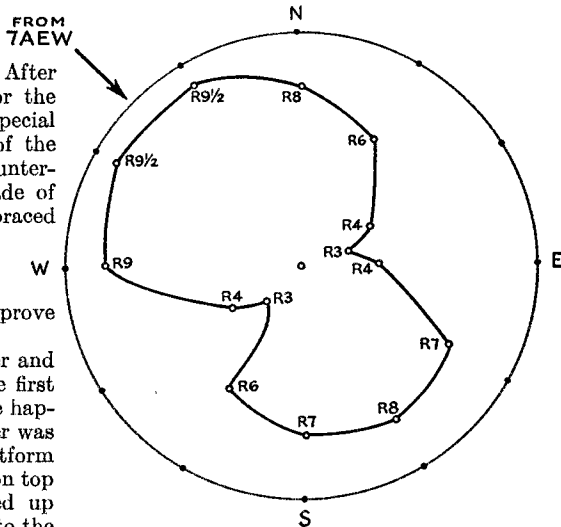

FIG. 2—RECEPTION PATTERN FOR FULL ROTATION OF ANTENNA ON RECEPTION

Signal values plotted relative to signal input to RME9D receiver required for R1 indication. Station observed and time selected for absence of fading and observations repeated for further check. The pattern is representative of usual experience in reception.

indicator in the shack, along with the push-button control, to tell exactly the direction of transmission on a calibrated meter scale. This has been worked out and will be in operation, we expect, at the same time the automatic rotation is installed.

ANTENNA AND REFLECTOR MOUNTING

Now for the actual mounting of the antenna and reflector, and the making of provisions for varying the spacing between the two as well as varying the length of each. All three of these variations are necessary to reach the ultimate in efficiency. The center supporting member indicated in Fig. 4 was cut to a length of 8 feet 3 inches from the center. A cross piece of the same material was mounted underneath to hold it in position. The cross piece was 28 inches in length. Porcelain insulators with a leakage path of better than four inches were mounted at each end of the "T" and served as the center supports for the two halves of the antenna. Similar insulators were mounted on the outside two supporting arms for the antenna side, right in line with the first two, and the distance from the center of the unit to the center of the insulators was 14 feet $4\frac{1}{2}$ inches.

The material used in the antenna in the final version is an aluminum alloy tube $\frac{1}{8}$ -inch in diameter of special design produced for this purpose. Each side of the antenna consists of a 14-foot section of this material with a $3\frac{1}{2}$ -foot section of a smaller tube that just telescopes inside the larger, providing the means of varying antenna length to the desired transmitting frequency. A small clamp is provided which allows a set screw to extend through a hole in the outer tubing, thus placing pressure against the inner tube and giving good contact between the two sections. The antenna is fed with EO1 transmission cable because of its extreme flexibility and ease with which

used in the antenna and reflector together is 12 pounds.

The tubing is mounted on the insulators with aluminum straps about one inch in width and $\frac{1}{16}$ -inch thick, so cut as to place a very firm pressure on the tubing when the mounting nuts are pulled down tight. A single insulator and strap hold the center together, though there is a one-foot section of the smaller tubing telescoped inside the middle joint in the reflector. The insulators used have a sufficiently long leakage path for any power permitted in the amateur hands since they are not located at high voltage points and the shellacked supporting arms are very good

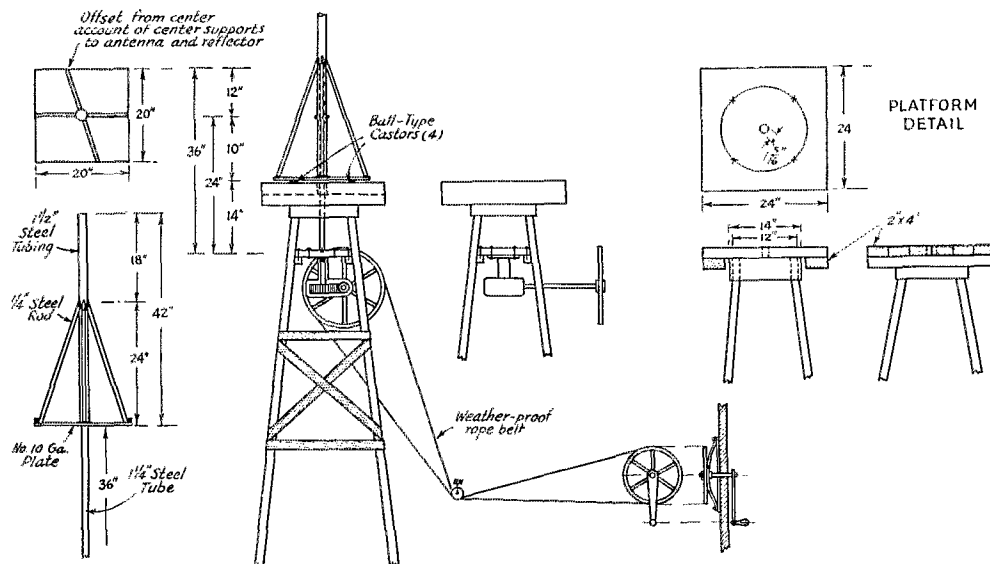

FIG. 3—DETAILS OF THE ROTATING MECHANISM

it may be coupled to any final amplifier. Straight inductive coupling was found desirable at this frequency and satisfactory for all practical purposes.

The reflector was mounted in a similar manner to the antenna, except that the "T" was not used on the center member. This was omitted in order that space variations between the antenna and reflector might be made by moving the insulators supporting the reflector closer to or farther away from the antenna. It was expected that the reflector would be farther back from the center than the antenna, which was desirable to provide a balance of weight since the antenna has the EO1 cable to support over a short distance. The reflector is of the same material as the antenna. This tubing is very light and strong. There is no visible droop in either the antenna or reflector although there are spans of ten feet with no support between points. The weight of the tubing

insulation in themselves. No trace of leakage has been detected to date.

ANTENNA AND REFLECTOR ADJUSTMENT FOR BEST RESULTS

Finally, after using the Signal Squirter on the air for some little time and becoming thoroughly convinced that the thing really did do the work, we went to work with the field-strength measuring equipment and started making final adjustments. There were several factors to be taken into consideration in doing this. First, the spacing between the two halves of the antenna; next, the exact length of the antenna; then, the spacing between the antenna and reflector; and finally, the length of the reflector.

To start with, the length of the antenna was computed and found to be very close to correct. It was finally lopped off about $\frac{1}{2}$ -inch on each side for a bit better efficiency. Of course this

change was easily made by sliding each end section of the antenna into or out of the larger section of tubing, the final adjustment being fastened firmly in place.

ords kept of all adjustments throughout the procedure, but space would hardly be warranted for the recording of all these. The final selection was 33 feet 10½ inches for our frequency of 14,215

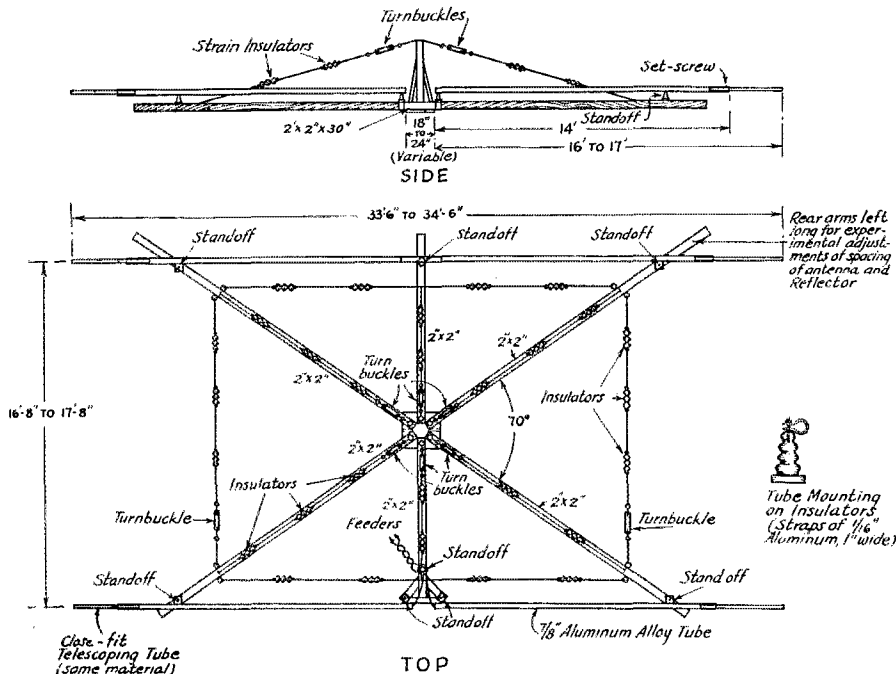

FIG. 4—CONSTRUCTION OF THE TOP ASSEMBLY CARRYING THE ANTENNA AND REFLECTOR

A very critical point was the proper spacing between the two halves of the antenna itself, this adjustment being quite necessary to give the best match to the EO1 cable. This adjustment brought considerable improvement and eliminated a tendency for standing waves to appear on the feeder system. Final adjustment finally settled down at about 22-inch separation between the adjacent ends of the two halves of the antenna.

Next came the location of the reflector back from the antenna. This spacing had been set arbitrarily at 17 feet so that the reflector might be moved back farther or up closer. The checks with the field-strength meter indicated very definitely that the spacing between the elements was important but not so critical as the actual length of the antenna and reflector. It was also found that the spacing between the two elements could be varied over a couple or three inches with little or no effect.

After having found that the reflector seemed to do its best job when at about 16 feet 10 inches instead of the usually recommended spacing of 17 feet 4 inches, we started pruning the reflector length as the final step in adjustment. Field strength measurements had been made and rec-

kc. The adjustments of reflector length were found to be quite effective and produced a noticeable difference as each change was made. In fact, it seemed at this stage of the game that the length of the reflector was fully as important as the antenna length, and that both of these were more important than the actual adjustment of space between the two elements in so far as critical and close adjustments were concerned.

The results as finally obtained in Fig. 1 were quite satisfactory to us and check very closely with reports on actual reception at distances greater than 1000 miles. Since revision of the top section, no changes have been made in the spacing, length of elements or otherwise in the radiating system, although actual operation shows that some further improvement might be possible, since our back radiation is a bit stronger than one might desire, perhaps producing a consequent lack of full concentration out front, which is where we want as much as we can get. A bit of time is needed to complete these measurements and a number of other experiments that might be carried on in development of such a unit.

The effectiveness of the Squirter has been

(Continued on page 104)

Inexpensive Utility Switchboard Type Racks for Amateur Equipment

By C. W. Van Duyne,* W3AKT

AS PERHAPS every amateur knows, there are many types of transmitter construction, ranging from breadboards to something like the new WOR layout, and the type of construction used depends upon the kind of work the transmitter is to do. Recently the author was quite severely bitten by the retransmission bug (i.e., a desire to patch low frequencies out on 56 mc., and *vice versa*); and the transmitter, being housed at the time in a steel kitchen cabinet obtained from a well-known mail-order house, did not adapt itself at all to this sport.

After some cogitation we were convinced that probably no one did more or better patching than the telephone company—so why not adopt their methods? Accordingly, the layout shown in the accompanying sketch and photograph was tried and found to be very satisfactory for both economy and utility. Also, when you slam a plug into a jack the jack stays firmly in place making it unnecessary to follow it around the shack.

Briefly, the switchboard consists of three 19-inch bays. The top and bottom supports and four upright pieces are made of dressed two-by-threes. These, of course, can be of almost any kind of wood provided they are straight, well seasoned and not too hard. The panel should be $\frac{3}{8}$ -inch three-ply ply-wood; that is, thick enough so that equipment may, if necessary, be screwed to the rear without the points of the screws showing up through the front of the panel. The top and bottom cross pieces are secured to the ceiling and floor with three brass screws at the points indi-

cated in Fig. 1. Relatively small wood screws are ample, since practically no weight is supported by these screws—and there is no need to agitate the OW or landlord unnecessarily.

The uprights, spaced 19 inches apart on centers, are secured to the top and bottom pieces by small corner angles. Give the entire framework, when completed, a coat of Moore's "Utilack" dull black paint. Use this paint on the panels also. Two coats will cover up all the grain in the wood and give a very good imitation of slate.

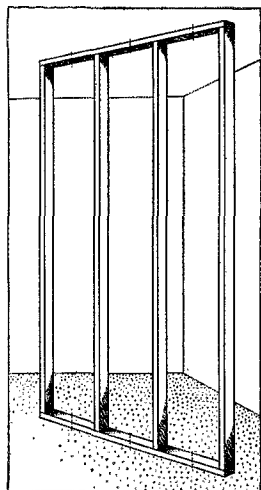
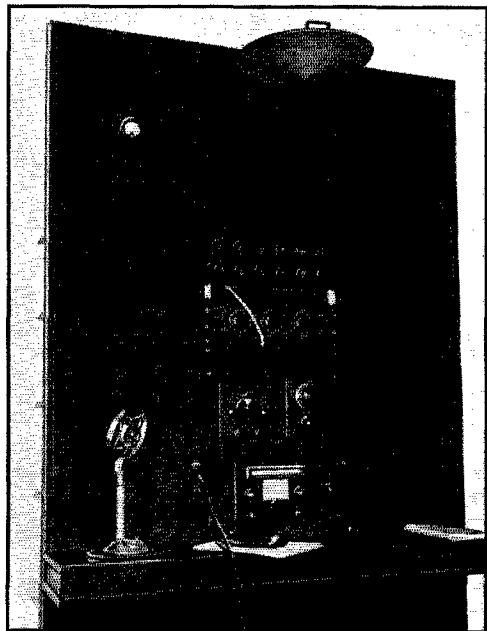

FIG. 1—THE TWO-BY-FOUR RAILS TO CARRY THE PANELS ARE ARRANGED THUS, WITH THE END PIECES FASTENED TO CEILING AND FLOOR SO THAT A PLUG MAY BE SLAMMED INTO A JACK WITHOUT TIPPING THE WHOLE ASSEMBLY



THE RECEIVER AND OTHER STANDARD PIECES OF EQUIPMENT ARE MOUNTED BEHIND CUT-OUTS IN THE PLY-WOOD PANELS, WHILE THE JACK-STRIP PROVIDES PLENTY OF PATCHING CONNECTIONS FOR THAT DESIRABLE FLEXIBILITY

Haywire may prevail in the rear without spoiling the professional front-panel appearance.

The key-shelf was constructed of wood on hand and has a hinged cover which, when closed, covers up call book, station log, patch cords and such, very nicely. The key-shelf at W3AKT is enamelled a very bright red, which is quite effective against the black background.

(Continued on page 104)

* 172 Lake Ave., Boonton, N. J.

Oscillators Using 14-Mc. Quartz Crystals

Circuits for High Output With New Thick-Cut Plates

By J. M. Wolfskill*

THE story of piezo-electric quartz crystals is, in general, well known. While their properties and characteristics can be predicted fairly well from mathematical considerations, there are still many improvements to be made. We have obtained crystals with practically zero temperature coefficient, crystals which are more active piezo-electrically, and crystals which are easier to handle and control insofar as parasitic frequencies are concerned. Very little has been done, however, to obtain crystals having a greater thickness-frequency ratio in order to extend the frequency range in which they can be used for direct control.

There always has been, and probably always will be, that pioneering spirit in the amateur to push onward and upward in frequency, to explore new territory, to discover new phenomena which exist at these higher frequencies. Any work at these higher frequencies, where the transmitter is to be crystal controlled, ordinarily demands considerable additional equipment because of the doubler and amplifier stages required. Reasonable outputs have been obtained at 28 mc. using crystal control with a forty-meter crystal, or even an eighty-meter crystal. However, the additional equipment required for good output is always a handicap and the attendant adjustments are many. Also, for frequencies higher than 30 mc. the outputs become very small. A rather elaborate setup is required for any decent power at 56 mc. using a forty-meter crystal; and even then the control is not what it might be. This has been a handicap for the amateur, and has probably kept many a good man from exploring in this virgin territory.

14-MC. CRYSTALS

Crystals for the 160-, 80-, and 40-meter bands are made in large quantities, and are used by amateurs the world over for transmitter control. A dependable 20-meter crystal has been a long-felt need; but because of their thinness and the difficulties encountered in manufacture, the old cuts held doubtful promise of such a crystal. It was with this in mind that work was begun on the development of a new 20-meter crystal cut. The objective was one which would not be too difficult to manufacture, one with a fairly low temperature coefficient of frequency, and one which would give considerable output when used

in a conventional transmitter. Although tourmaline crystals have been used to some extent for 14- and 28-mc. direct control (and even for 56-mc.), the cost of such crystals is well beyond the reach of most amateurs, and their performance at times erratic. Because of the high cost of the raw tourmaline, as well as the cost of manufacturing, they gave little promise of being a satisfactory crystal for twenty-meter work, from a price standpoint rather than from piezo-electric properties.

From these considerations, development work was continued on the use of quartz to obtain higher frequency crystals. An optimum cut, employing a new operating principle, was discovered which had a considerably higher thickness coefficient than the X-cut. At the same time, the temperature coefficient was reduced to 20 cycles per megacycle per degree Centigrade, which is less than that of the X-cut. This drift is in a positive direction, and although it may seem large when compared to the

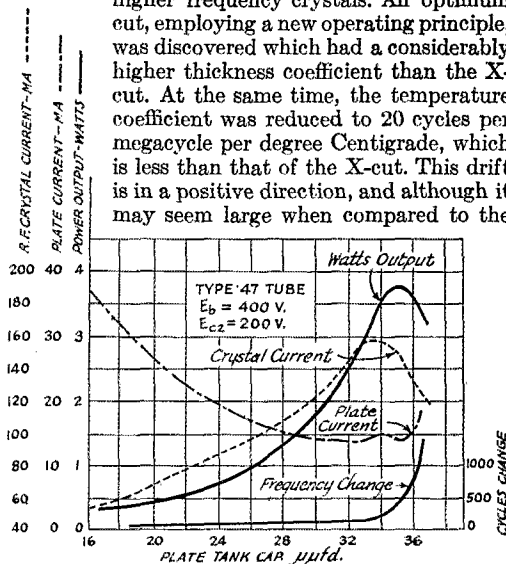

FIG. 1—PERFORMANCE CURVES OF 14-MC. QUARTZ CRYSTAL OSCILLATOR USING TYPE 47 TUBE IN CIRCUIT OF FIG. 2

new low drift crystals, it stabilizes very readily at about 40 or 45 degrees Centigrade, depending on the crystal current and the type of mounting.¹ The fact that a considerable number of amateurs are still using X-cuts of greater drift would seem to indicate that drift of this order is not a serious objection.

Due to the increased thickness, the attendant

¹ It is inadvisable to use the crystal in a mounting not especially designed for it. We are informed that this type crystal is only supplied mounted in a special low-loss holder. —EDITOR.

* Biley Electric Company, Erie, Penna.

ills of previous twenty-meter crystals, such as brush discharge and high r.f. crystal current resulting in fracture, are not present and cause no trouble. The crystal r.f. current may be run up to 200 ma. without danger of fracture, although the operating current should be kept around 150 ma.

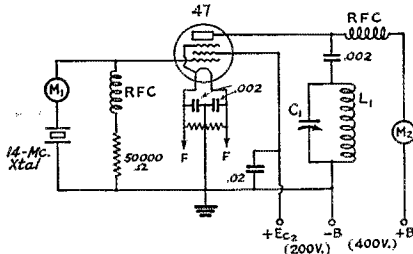

FIG. 2—PENTODE OSCILLATOR CIRCUIT FOR 14-MC. CRYSTALS

L_1 —8 turns No. 12 enameled wire on $1\frac{1}{2}$ -inch diameter form, $1\frac{1}{2}$ -inch length of coil.
 C_1 —100- μ d. variable condenser.
 M_1 —R.f. ammeter (0-500 ma.)
 M_2 —D.c. milliammeter (0-50 ma.).

This fact, together with their face size (approximately 0.7 by 0.9 inch) enables them to handle considerable power. They can be ground to any frequency in the twenty-meter band and, because of their high activity, make excellent oscillators in most of the present-day conventional oscillator circuits.

CIRCUIT BEHAVIOR

These crystals have been tested in various transmitter circuits using doubling schemes to obtain 10- and 5-meter output. In doing this an attempt has been made to adhere to simple circuits and tubes, particularly those with which the amateur is already familiar. At the same time, however, any changes in circuit design which improved the operation of the crystal were noted and these are discussed below.

The operating characteristics of a 14-mc. crystal oscillator using a Type 47 tube are shown in Fig. 1. These curves, although made on a twenty-meter crystal, are also generally representative for crystal oscillator circuits of this type. Notice particularly that maximum output does not occur at maximum crystal current, but slightly beyond that point, a good operating range being between 32 and 35 μ d. on the tank condenser. Also notice the smoothness of the curves, indicating absolutely single frequency response for a large variation in the tank condenser. The total frequency change over the entire range from 12 to 36.5 μ d. for which the crystal oscillated was not over 1500 cycles. This variation will naturally depend to some extent on the L/C ratio in the tank circuit and on the type of tube.² For a given

² For data on the advantages of pentodes over triodes see, "Which Tube for the Crystal Oscillator," by George Grammer, Feb. 1932 *QST*.—EDITOR.

ratio, however, it is a good indicator of the controlling power of the crystal.

CIRCUITS

With an ordinary pentode crystal oscillator circuit as shown in Fig. 2, using a Type 47 tube and a twenty-meter crystal, output of approximately 4 watts is obtained with screen and plate voltages of 200 and 400 volts respectively. This is comparable to the fundamental output of a 40-meter crystal using the same tube and voltages. The same output on 20 meters was obtained using a 2A5 tube; with this tube, however, it was necessary to tie the cathode to the center tap of the heater winding to get maximum output. Other tubes used were the RK-20, RK-23, 59, and 6A6 or 53, the crystal giving good performance and sufficient excitation for all these tubes without excessive crystal current. In these circuits both series and parallel feed was used with no appreciable difference in their operation. A reasonably high L -to- C ratio should be used in the plate tank circuit for maximum power.

Using the RK-20, outputs of 40 watts were obtained direct from one of these 20-meter crystals. Using it as a Tri-tet oscillator, it gave an output of 15 watts at 10 meters (second harmonic).

Excellent results were obtained using a Type 53 or 6A6 tube. This twin-triode type tube is convenient as a crystal oscillator and may be used either as a push-pull oscillator with the crystal

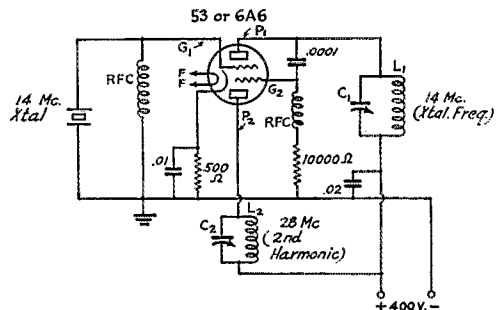

FIG. 3—TWIN-TRIODE DOUBLER CIRCUIT

L_1 and C_1 —Same as Fig. 2.
 L_2 —5 turns No. 12 enameled on $1\frac{1}{2}$ -inch diameter, 1-inch length of coil.
 C_2 —100- μ d. variable.

across the two grids; or as an oscillator-doubler, as shown in Fig. 3. High outputs may be obtained with relatively low plate voltage, its harmonic output being considerably higher with 400-volt plate supply than when using a Tri-tet oscillator with 500-volt supply.³ Several of the 20-meter crystals were used with this twin-triode tube and

³ As originally described in *QST* (June 1933), frequency stability with quite wide variation in circuit constants was considered the prime desirable characteristic of the Tri-tet circuit, with harmonic-generating ability a secondary matter. The twin-triode combinations are considerably less stable with reactance changes in the circuit.—EDITOR.

the circuit shown, and outputs of 2 watts were obtained on 10 meters without regeneration in the second triode section. This circuit is easy to adjust and outputs of 2 watts or more on 10 meters, with twin-triode tube crystal control, is to be heralded as somewhat of an accomplishment. The circuit constants and coil turns are given in Fig. 3 and, because of the simplicity, no difficulty should be

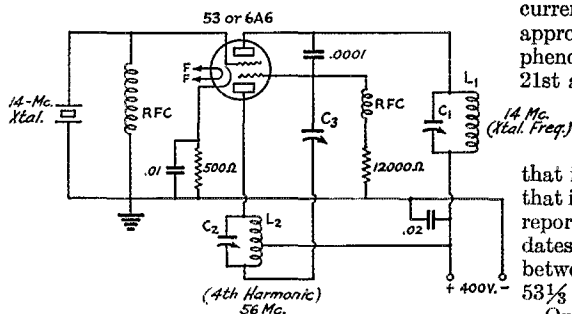

FIG. 4—REGENERATIVE TWIN-TRIODE QUADRUPLER CIRCUIT

L_1 and C_1 —Same as Fig. 2.

L_2 and C_2 —Same as Fig. 3, but center-tapped and tuned to 56 mc.

C_3 —Regeneration control, 25- μ d. midget variable.

experienced in duplicating these results. By using regeneration in the harmonic section of the oscillator, as shown in Fig. 4, this output may be increased on 10 meters, and $\frac{3}{4}$ -watt output may be obtained on 5 meters. Regeneration, however, makes the circuit more difficult of adjustment and is hardly worth using if doubling only is desired. If it is used for quadrupling to 5 meters, the feedback must be carefully controlled, so that the circuit does not oscillate at the frequency determined by the harmonic-tuned triode circuit.

The use of 20-meter crystals should open up to amateurs a new field in which crystal control may be used, and with the 6A6 tube in the circuits described, 56-mc. crystal control is definitely within reach. The development of this type crystal also has significance because it opens up new and greater possibilities of practical 10-meter quartz crystals to control our transmitters.

A New Radio Transmission Phenomenon

DR. J. H. DELLINGER, chief of the radio section of the National Bureau of Standards, has recently called attention to a newly-observed periodic variation in radio transmission of the most remarkable character. The phenomenon consists of the complete wiping out of all high-frequency long-distance radio signals on the illuminated side of the globe for a period of about fifteen minutes, at fairly regular intervals of about fifty-four days, twice the period of rotation of the sun.

This complete drop-out of signals was noted over the illuminated half of the globe (not the night side) on March 20th, May 12th, July 6th and August 30th. It is believed to depend upon some emanation from the sun and its eventual analysis probably will require the study of such cosmic data as solar radiation intensity, terrestrial magnetism, atmospheric ionization, earth currents, aurora, cosmic rays, meteors, etc. The approximate 54-day period indicated that the phenomena might occur again between October 21st and 25th but at the moment of writing no conclusive reports for this period have been received. This may mean that the phenomenon did not occur this time, or

that it was missed because of short duration, or that it occurred on the other hemisphere and the reports have not yet arrived. The bracketing dates are derived from the fact that the interval between the appearances has varied between $53\frac{1}{2}$ and $55\frac{1}{2}$ days.

On May 12, 1935, the French "radio central" receiving station near Paris experienced a sudden fading out of all high-frequency signals, so rapidly that the operators thought the power supply had failed. This wipe-out occurred at 1157 G.T. and signals returned to normal by 1215 G.T. R.C.A.C. at Riverhead and A.T. & T. at Neteong confirmed from their records the experiencing of the same effect at precisely the same time. Other fade-outs of record occurred on March 20th at 0150-0205 G.T., and on July 6th at 1409-1425 G.T. Careful watch was made for a recurrence between August 28th and 30th and it duly put in its appearance on August 30th at 2320-2335 G.T.

It is a little amazing that this phenomenon went so long unobserved. Looking back on it now, there must have been many a time when we sat before perfectly dead tuners, wondering what was the matter, only to find the signals restored before trouble could be located. The first reported instance in A.R.R.L.'s files was received from F. D. Jenkins, W4SB, of Atlanta, under date of November 28, 1934. Mr. Jenkins reported that on this date at 11:10 a.m., C.S.T., signals at the Eastern Air Lines aeronautical station, WEEA, dropped out completely in the middle of a message being transmitted by WEEG, Greensboro, N. C. The entire Eastern Air Lines net from Newark to Miami was dead for thirty minutes on their daytime frequencies of 4122 and 4745 kc.! During the dead period, W4SB tuned over both 80- and 40-meter amateur bands but not a single signal was logged. Broadcast frequencies, however, were normal, WLW and locals being received in Atlanta. At 11:40 a.m. receivers suddenly resumed normal operation. Mr. Jenkins says the fading was the quickest and most complete he ever observed either as an amateur or a professional. The time this was observed was twice $55\frac{1}{2}$ days from the occurrence on March

(Continued on page 29)

What the League is Doing

League Activities, Washington Notes, Board Actions—For Your Information

Election Results

When the nominations in the 1935 director elections were examined by the Executive Committee on November 1st, it was found that three divisions had nominated only their present directors. It is provided in our by-laws that under these circumstances the candidates are declared elected without balloting by the membership. Thus we have to report that Carl L. Jabs, W9BVH, of St. Paul, continues in office for 1936-1937 as the director of the Dakota Division; and similarly S. G. Culver, W6AN of Berkeley, Calif., for the Pacific Division; and Bennett R. Adams, Jr., W4APU, of Homewood, Ala., for the Southeastern Division. In the latter division a nomination was also filed for Sam S. Harben, W4DKZ, of Gainesville, Ga., but was invalid because it bore the signature of only nine members of the Southeastern Division.

By sheer happenstance the same divisions named only one candidate each for alternate director, and these have similarly been declared elected for the 1936-1937 term: Fred W. Young, W9MZN, Mankato, Minn., for the Dakota Division; E. L. McCargar, W6EY, Oakland, Calif., for the Pacific Division; and S. J. Bayne, W4AAQ, Birmingham, for the Southeastern Division. Thus in these divisions there is no balloting this year by the membership.

Fremont F. Purdy, W4AFM, of Kingsport, Tenn., was the only candidate for alternate director of the Delta Division, and has been declared elected to that post for the coming term.

In all the remaining areas having elections this year, there is more than one candidate and the members are now making their choice by ballot. The candidates are:

For Canadian General Manager: J. Leonard Walker, VE3JI; Leonard W. Mitchell, VE3AZ; Alex Reid, VE2BE, the incumbent; Samuel B. Trainer, Jr., VE3GT. There were no nominations for alternate C.G.M.

For Atlantic Division Director: Lawrence D. Geno, W8PE; Eugene C. Woodruff, W8CMP, the incumbent, Gilbert L. Crossley of W8XE was also nominated for director but withdrew his name. For alternate: Ward J. Hinkle, W8FEU; W. Bradley Martin, W3QV; Roy C. Corderman, W3ZD.

For director of the Delta Division: E. Ray Arledge, W5SI; E. H. Treadaway, W5DKR.

For Midwest Division Director: H. W. Kerr, W9DZW-W9GP; Floyd E. Norwine, Jr.,

W9EFC; Frank J. Sadilek, W9APM. For alternate: O. J. Spetter, W9FLG; Phil D. Boardman, W9LEZ.

For Southwestern Division Director: Charles E. Blalack, W6GG; Walter W. Matney, W6EQM. For alternate: William L. Seitz, W6HXU; Phillip S. Snyder, W6UT.

Election results will be broadcast from W1MK throughout the evening of December 20th.

Boundary The F.C.C. has relocated the boundary between its Districts Nos. 11 and 12 in California so as to transfer Inyo County to the 11th Radio District with headquarters at Los Angeles, and the counties of Monterey, Kings and Tulare to the 12th Radio District (San Francisco). Sort of making their line resemble that between our Pacific and Southwestern Divisions.

Portables A number of amateurs have received six-months suspension of operator license at the hands of the F.C.C. for operating under their own calls with portable status at a fixed station not owned by them. In most of the cases the station thus operated was one not yet licensed, the amateurs believing that they could legalize this operation by calling it their portable. The Commission calls this the operation of an unlicensed station, for which heavy penalties are provided. They state that the portable privilege applies only to apparatus which is portable and which in fact is from time to time moved from place to place. Although an amateur does not have to own the apparatus he employs, they point out that the license application form obliges him to make a showing that he possesses control in the case of apparatus not owned by him, and such showing of control has not been made in these cases. In fact, most of the amateurs who have been thus penalized have failed to notify the radio inspector of their intended portable operation, have not signed the portable indication, and have not kept a log. The A.R.R.L. feels that the Commission's rules are not sufficiently clear on this subject, that there are some contradictions, and the League hopes to arrange for an early clarification. In the meantime we suggest that all amateurs confine their operation in portable status to *bona fide* personal portable operation; that is, apparatus which is in fact portable and which is indisputably licensed and under their control.

War News

Ethiopia's lone point-to-point station, ETA, can be heard on this coast handling news and the traffic of war correspondents. At this writing it is coming in well on 7620 kc. in the early evening and on 18,270 kc. during the forenoons. The French station at Djibouti, FZE, also comes in splendidly on 7635 kc. from about 5 p.m. to 8 p.m., E.S.T. The Department of State has a temporary semi-portable station at Addis-Ababa manned by four Navy operators and operating under the call NCO, frequencies unknown to us but to be somewhere in the vicinity of 9 mc. This station will handle only official U. S. government business. All of this is addressed traffic and the secrecy regulations fully apply.

Conferences

The I.A.R.U. has notified the Spanish administration, custodian of such matters under the Madrid treaty, of its intention to participate in the work of the C.C.I.R. The United States does not now expect to call the conferences to prepare its position for the Bucharest C.C.I.R. meeting until after the first of the year. No definite decision has been reached regarding the meetings that will prepare for Cairo, but it is believed that they will not be called until the early autumn of next year.

Cairo Observers

The Cairo Committee of the A.R.R.L. Board is distributing identifying buttons to the observers enrolled in its occupancy surveys. The buttons carry the words "Cairo Observer—For More Frequencies" and are distributed by the group controls and club overseers upon the turning in of reports. Pins only to workers—no drones. Have you got yours yet?

QSL

Mr. Frank P. Barnes, K7DVF, has kindly consented to act as Alaskan QSL manager. His address is Box 297, Wrangell, Alaska. Appointments are yet to be made in K6 and KA.

Ratifications

Hungary and the Dominican Republic are now announced as having ratified the Madrid Convention and its radio regulations, and the same are now in force as between the United States and those countries.

Visiting Members

A good many hundred amateurs visited A.R.R.L. headquarters in West Hartford during the past summer, mostly while touring New England. We averaged at least a half dozen a day during the vacation months. For our part, representatives from headquarters have appeared before amateur gatherings during the two months preceding this writing at the following rather representative list of places: Birmingham, Charleston, S. C., Charlotte, N. C., Chicago, Columbia, S. C., Denver,

Fargo, Greeley, Colo., Haddonfield, N. J., Indianapolis, Joplin, Mo., Kansas City, Lake Bluff, Ill., Memphis, Miami, Missoula, Mont., Minneapolis, Omaha, Pine Bluff, Schenectady, Spokane, Valparaiso, Fla., and Washington. The railroads ought to be paying dividends pretty soon.

Figures

Here are a few statistics that will put your eye out. About 150,000 letters are received annually at A.R.R.L. headquarters. In addition to this there are every year more than 5000 copies of magazines, more than 100,000 QSL cards. A million words of copy are written annually for A.R.R.L. publication, equivalent to more than 15 ordinary books. Our mimeograph ran over 400,000 pages of bulletins and circular letters last year—and the office boy handled it single-handed in addition to his other duties. Last year the League spent \$4.35 per member to create and supply QST. In addition, an average of \$2.78 per member was expended for legislative protection, Washington representation, maintenance of the communications department, field travel, the technical information service and secretarial work. On top of this there were appropriations by the Board for director meetings, the expenses of directors during the year, special committees, international representation and so on. Grand total last year, \$9.06 per member. Many an engineering or technical society has dues of \$10.00 per year and performs not half the services for its members that A.R.R.L. does. The League member pays only its annual dues of \$2.50, the balance being earned by the League through the sale of advertising space and its miscellaneous publications.

Strays

We are sorry to have to say that the listing of Joseph Schwartz, W2CIH, in Silent Keys in July QST, was the result of someone's perverted attempt to be humorous. CIH wishes it to be known that he's very much in the land of the living.

DX

Breathes there a brass-pounder, soul so dead
Who never gave up sleep and bed
That he might work some foreign land,
Whose heart has ne'er within him churned,
As 'round and 'round the dials he turned
To listen o'er the noisy band?
If such there breathes, he'll find it true
No matter how much he calls CQ,
High though his power, mighty his sig,
Complex the circuit, costly the rig,
His chirp will never leave our sod,
For he'll be jinxed by the Radio God
Until he sits a whole night through,
And gets the DX spirit too!
—W3BHB, with apologies to Sir Walter Scott

Self-Regulating Grid-Bias Supply for Multi-Stage Transmitters

By A. W. Friend,* W8DSJ-W8KIU

LATE radio literature has described several methods and devices for attempting to prevent the "soaring grid bias" on power amplifiers using rectifier-filter types of grid bias sources.¹ Why should we prevent this change in grid bias? In some cases it is desirable to maintain perfectly fixed grid bias; but with most ordinary Class-C systems it is only necessary to have complete control over the grid bias at zero and maximum excitation of the amplifier tube. The thing which it is very desirable to prevent is interaction with the changing grid biases of several different stages of an amplifier. The operation of one stage may change the bias applied to another stage sufficiently to cause trouble.

A system which I have developed limits the interaction between the various stages only to that variation caused by the regulation of the rectifier-filter system of the bias voltage supply itself. This regulation can very easily be held within the desirable limits. The system is illustrated by Fig. 1. Each amplifier stage receives its grid bias from a separate anode of a diode rectifier tube connected, as shown, across the bias supply output. By the use of a resistor with two adjustable taps, the minimum and the maximum grid bias can be set to any desired value. When under load, the rectifier-filter system must supply at least the minimum voltage required for the biasing of the grid of the tube which requires the highest grid bias with no excitation applied.

With no excitation applied to a Class-C amplifier, the bias may be adjusted so as to cut off the plate current. Simultaneously with the above condition, the resistance in each -C lead should have a value which will develop the desired maximum grid bias when the maximum grid current is flowing (maximum input condition). This value may be calculated by Ohm's Law:

With no excitation applied to a Class-C amplifier, the bias may be adjusted so as to cut off the plate current. Simultaneously with the above condition, the resistance in each -C lead should have a value which will develop the desired maximum grid bias when the maximum grid current is flowing (maximum input condition). This value may be calculated by Ohm's Law:

$$R = \frac{E_g}{I_g}$$

where E_g = the maximum grid bias voltage desired and I_g = the (d.c.) grid current (in amperes) at full excitation. For instance, if a grid bias of 300 volts (maximum) is desired for a tube which will draw a grid current of 50 milliamperes (0.05 ampere), the resistance to which the bias tap should be set is

$$R = \frac{300}{0.05} = 60000 \text{ ohms}$$

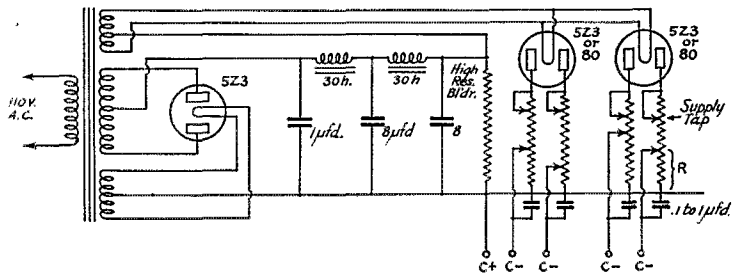

FIG. 1—CIRCUIT ARRANGEMENT OF DIODE "VALVE ACTION" BIAS DIVIDERS FOR MULTI-STAGE TRANSMITTERS
Determination of resistance values is discussed in the text.

The -C tap should first be set to approximately 6000 ohms; and then the supply tap (from the diode plate) should be set so that the bias applied to the grid without excitation will cause cut-off of the plate current. After the excitation has been applied and all current and voltage readings have been checked, any slight changes of adjustment which are found to be necessary may easily be made. After several stages have been connected to the bias supply some slight final adjustments may be found to be necessary in the biasing of the stages connected first.

Two very great advantages of this system are that in case of failure of the bias supply voltage, automatic bias will be effected as long as the amplifier is excited, and (the main advantage) that a low-voltage bias supply will suffice for an amplifier requiring a bias nearly double the voltage of the supply. The diode tubes prevent the bias voltage built up in the grid circuit from "backing up" into the lower voltage supply circuits and possibly breaking down the filter condensers, as well as from acting upon the grids of other tubes.

(Continued on page 84)

* Physics Department, West Virginia University, Morgantown, West Virginia.

¹ Yates, "Automatic Vacuum-Tube Regulation Control," *QST*, Sept., 1934; also, "874 Regulator," Experimenters' Section, same issue; Robinson, "Gaseous Voltage Regulators," *QST*, Jan., 1935; Priest and Olney, "Vacuum-Tube Voltage Regulators," *QST*, July, 1935.—EDITOR.

Class-B Carrier Control in the Low-Power 'Phone

Practical Construction and Adjustment of an Effective 50-Watt Type Transmitter

By Henry S. Keen,* W2CTK

IT MIGHT be said that the purpose of a good 'phone transmitter is not just to put out the theoretically best signal on the air, but to push the most intelligible signal out of the other fellow's loud speaker. The answer is not wholly one of audio quality or fidelity, for the most beautiful 'phone signal e'er breathed on the air can be completely washed out by a couple of nice (?) husky heterodynes, or spurious sidebands from an overmodulated neighbor, and rendered completely null and void. It appears that in addition to yelling for more frequencies, it would behoove us to clean house. The F.C.C. will take care of the overmodulation, so let's get busy on the heterodynes, ourselves.

One answer to the problem is voice-controlled carrier, as introduced some time ago in *QST*.¹ The outfit described herewith, employing the Class-B audio stage for both carrier control and modulation, has been in operation for over five months, and has proved very satisfactory. On direct tests under heavy QRM we have been told that the controlled-carrier signal came through perfectly, under conditions where the constant-carrier signal made no headway at all. Not only will controlled carrier put your signals through the racket much better than constant carrier, but it will give the other fellow a break.

In the outfit described, a pair of old 10's has been run at about 140 watts input (peak). When replaced by new tubes, the plate and grid currents are identical, with either controlled or constant carrier; so the tubes seem to be standing up.

* 1330 East 28th Street, Brooklyn, N. Y.

¹ Fyler, "'Phone Transmission With Voice-Controlled Carrier Power," *QST*, Jan., 1935.

THE R.F. EXCITER

The exciter unit, the circuit of which is shown in Fig. 1, is built on a sheet iron base, 8 by 13 by 3 inches, after the commercial manner. A circle cutter, used with plenty of oil and elbow grease, did for the tube and socket holes. The sockets are all of the usual wafer type. The three midget tuning condensers, C_1 , C_2 and C_4 , were mounted on a strip of hard rubber panel material, two inches wide. Three holes large enough to clear the shafts were then cut in the front face of the base, and the tuning condenser assembly bolted in place under the base. The buffer tuning condenser, C_3 , being a split-stator affair with a grounded shaft, does not have to be mounted on insulating material.

All connections to the exciter are made through a row of plugs mounted in a strip of hard rubber panel material, and fastened on the back face of the base. The corresponding row of jacks is mounted to the frame which is built after the fashion of a book-case. The panels are fastened to the front faces or base boards of each separate unit. The two lower shelves of the frame are devoted to housing the power supplies and the two 45-volt "C" batteries. In the photo of the complete assembly, the panel has been left off the lower "floor" to give a view of the main power supplies.

The oscillator is the old reliable 47 tube. After many different doubler circuits were tried, the one given in Fig. 2 was arrived at, using a 46 tube with excitation applied to one grid and regeneration to the other.² The output of the doubler is considerably boosted by use of the tickler coil, and as only one grid of the 46 is excited, it is unnecessary to tap the oscillator coil. The buffer is

² Keen, "An Effective Power-Type Frequency Multiplier," *QST*, March, 1932.

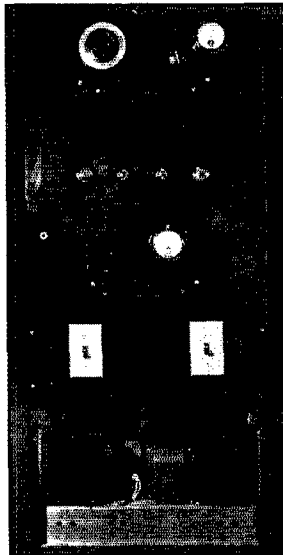

FRONT VIEW OF THE TRANSMITTER WITH LOWER PANEL REMOVED TO SHOW THE HIGH-VOLTAGE POWER SUPPLY

Either controlled-carrier or constant-carrier 'phone transmission can be used by simply flipping a switch, the "top" carrier output being 50 watts or so. A carrier-control power ratio of 20 or more is obtained.

link-coupled to the final amplifier grids, a one-turn link being used. Shields are used over the oscillator and doubler coils, but this is not essential.

transformer to push-pull. There are no tricks needed to get it to working. The second stage is another 53 used this time as a straight push-pull stage, resistance-capacity coupled to the preceding and the following stages. The 45 driver stage is perfectly straightforward. Separate bias is used to avoid loss of plate voltage in a bias dropping resistor. None of the cathode resistors in the first two stages are by-passed.

The Class-B transformers were originally intended for use with 10's in the modulator. It is likely, however, that an input transformer designed to couple to a pair of 46's would be somewhat better for use with Type 841 tubes. The Class-B output transformer is a home-made affair designed to couple a pair of 10's to a 5000-ohm load. Any of the standard transformers on the market designed to do this, with 750 volts or so on the plates, would probably do the trick at least as well.

FINAL AMPLIFIER

The modulated Class-C stage circuit is given in Fig. 2. This unit more or less follows the breadboard style of construction. Since the filaments of the final are over 700 volts positive with respect to ground, it wasn't deemed wise to use any metal base on this stage.

Two Cardwell "Trim-Air" condensers were ganged to make a split-stator grid tuning condenser. A rebuilt Cardwell receiving condenser (already double-spaced) was converted to split stator for the final plate tank. A pair of double-spaced midget condensers attend to the neutralizing. A receiving size r.f. choke is used for the plate feed, since the average value of plate current is not excessive.

POWER SUPPLIES

The speech amplifier power supply is the usual low-power job, a b.c.l. transformer and an 80 rectifier, a 30-henry choke, and a double 8- μ f.d. electrolytic filter condenser being its principal components.

The power supply for the r.f. exciter stages, which is also conventional, consists of a transformer giving 575 volts on each side of the center

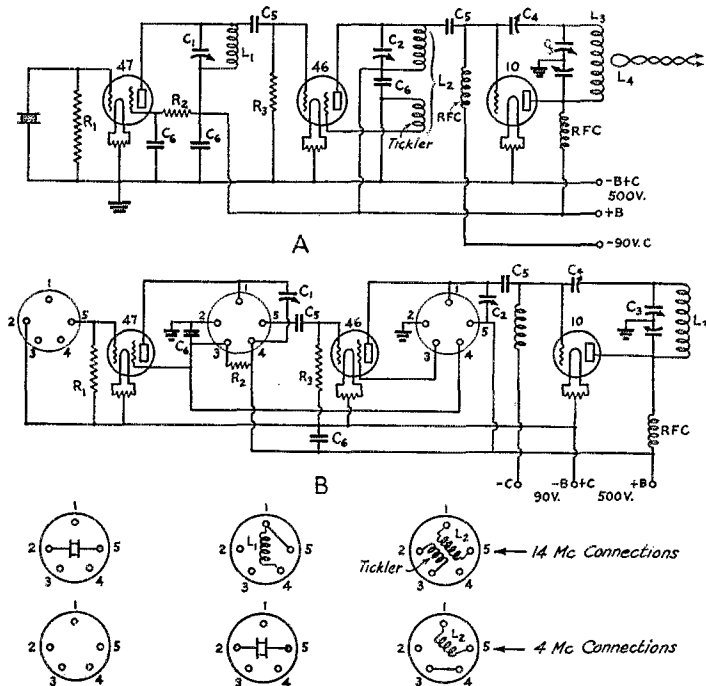

FIG. 1—(A) R. F. EXCITER CIRCUIT AND (B) COIL CONNECTIONS
 L_1, L_2, L_3, L_4 — See coil table
 C_1, C_3 —33 μ f.d. midget variable condensers
 C_2 — Double 35- μ f.d. double-spaced midget
 C_4 — Double-spaced 25- μ f.d. midget
 C_5 — 0.001- μ f.d. mica
 C_6 — 0.002- μ f.d. mica
 R_1 — 25,000-ohm 1-watt
 R_2 — 50,000-ohm 5-watt
 R_3 — 30,000-ohm 1-watt

The oscillator and buffer plate coils are wound on five-prong forms, connected as in Fig. 1-B. Thus, when operation at the crystal frequency is desired, the doubler becomes the oscillator. The crystal is plugged in where the oscillator coil used to be, and the 47 oscillator tube is shifted along to the socket formerly occupied by the 46 doubler. All other changes in the circuit are made by changing the coils.

AUDIO SYSTEM

The audio driver unit is a three-stage affair, ending in a pair of push-pull 45 tubes. The layout is apparent in the photo of the audio system while the circuit is given in Fig. 2. The base is 8 by 10 by 12 inches, and is made of a non-magnetic alloy. The volume control is not mounted on the panel, but on one end of the audio driver base, to facilitate removal of the same for possible repairs or adjustments.

The first stage is a 53 tube used as a phase inverter, to accommodate the single-ended mike

tap, an 83 rectifier tube, a 20-henry choke and two 4- μ fd. electrolytics. These condensers are obtained by hooking the sections of a double 8- μ fd. condenser in series. Condenser input is used to the filter. This feeds the oscillator, multiplier and buffer stages.

The first steps in putting in controlled-carrier are to change over the main power supply to get double the usual voltage. In this case it was easily done, as separate supplies had already been arranged for the modulator and final amplifier. The two main transformers give slightly over 800 volts on each side. Type 82 rectifier tubes have been used for the last six months and there has been, so far, no tube failure. The filaments are kept hot by a separate filament transformer. The filter consists of a double choke and a pair of 1000-volt 8- μ fd. electrolytic condensers in series. Each condenser is shunted with a 40,000-ohm resistor which divides the voltage for each condenser, and acts as a bleeder for the entire pack. The choke is rated around fifteen henries and is not a swinging choke. Hum has never been reported on the carrier, so the filter appears to be adequate.

An alternative to this power pack would be a bridge type, as previously shown by G. W. Fyler.¹

the carrier to "follow" perfectly, but the second harmonic distortion will become excessive.

On the other hand, a large condenser still removes the second harmonic distortion, but the carrier becomes sluggish and won't follow the

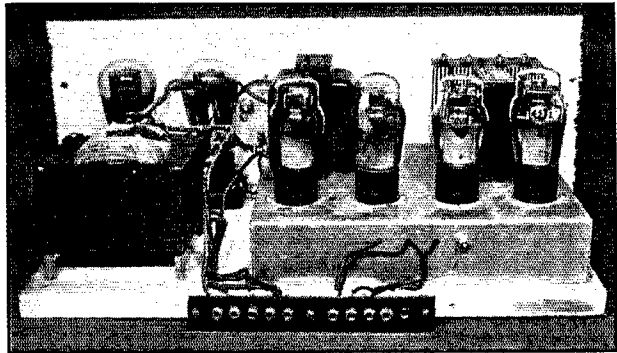

SPEECH AMPLIFIER (RIGHT) AND MODULATOR (LEFT) OF THE AUDIO SYSTEM

speech quickly enough to prevent momentary overmodulation and "mushiness." At this station a 4- μ fd. electrolytic condenser was used for several months, but it was found that substitution of paper condensers cleared up the speech and the amplifier "followed" faster. About 3 μ fd. seems to be the best all-round value for this capacitance.

The control range of Class-C plate current used in this outfit is from 40 ma. to 190 ma. or, in terms of power ratio, over 20 to 1. If a higher ratio of control were attempted it would be necessary to reduce C_s , to allow the final amplifier to "follow" faster. If an extreme ratio were to be used, C_s would have to be very small, so that in order to prevent excessive distortion it would be necessary to filter out or attenuate some of the low voice frequencies by means of a high-pass filter, or similar arrangement. To this end a condenser of 250 μ fd. has been used in the input grid of the first 53 speech amplifier. But if fair fidelity, with good reproduction on the extreme low tones is desired, C_s must be large, and the control ratio will then have to be made smaller to prevent overmodulation.

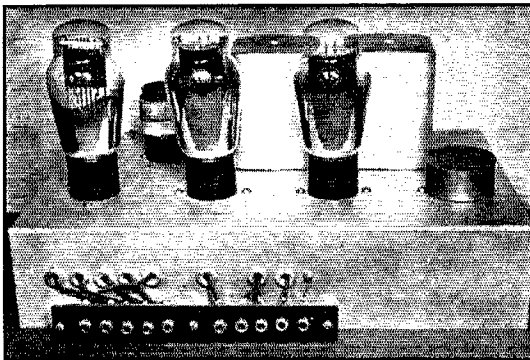

REAR VIEW OF THE R.F. EXCITER UNIT, SHOWING THE CONVENIENT JACK STRIP FOR MAKING CONNECTIONS WHEN THE UNIT IS SLID INTO PLACE

CARRIER-CONTROL RATIO

As is necessary with this controlled-carrier system, the Class-B modulator plate circuits in parallel are connected in series with the Class-C amplifier. In the center tap of any push-pull amplifier operated Class-B a very strong second harmonic is generated. A Class-B audio amplifier is no exception. In order to prevent this second harmonic from series modulating the final amplifier, it must be by-passed out by means of condenser C_s . If this condenser is small it may allow

PREVENTION OF OVERMODULATION

Since it takes 50% as much pure-tone audio power as d.c. input to completely modulate a carrier, the useful efficiency of the modulator should not exceed 50%. This can be accomplished in several ways; first, by shunting the secondary of the Class-B output transformer with a resistor of a proper value. The excess audio power is then dissipated in the resistor. Alternatively, the modulator can be operated into a lowered value

of load impedance. This effectively lowers the efficiency. This modulator operates into a load impedance of about 3700 ohms instead of the 5000 ohms for which the transformer is wound. At

the plate current up to somewhat less than 200 ma.

Note the antenna current. Now get some source of reasonably pure-tone sound to swing

the modulator plate current up to the same value as the final amplifier, and hold it there for a while. Did the antenna current increase over 20% or so? If it did, put the resistor across the secondary of the Class-B transformer to absorb the surplus power. If it's a wire-wound affair with a slide, we can adjust to the best value. Over-modulation is the least efficient method of all to increase signal strength, and the most obnoxious; so keep on the right side of the fence. Now that the modulator is properly loaded, we can cut in the control by opening switch *Sw*.

Accidental overmodulation will now be practically prevented, because it will be next to impossible to drive the plate current over

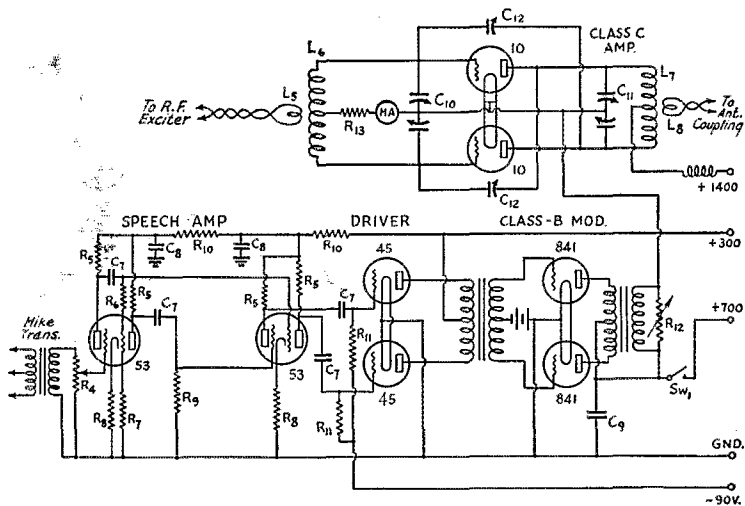

FIG. 2—CIRCUIT OF THE AUDIO SYSTEM AND CLASS-C AMPLIFIER

- L_1, L_6, L_7, L_8 — See coil table
- C_1 — 0.1- μ fd. paper
- C_3 — 1.0- μ fd. paper
- C_9 — 2- to 3- μ fd. 2000-volt (See text)
- C_{10} — Double 35- μ fd. midger
- C_{11} — Split-stator double-spaced, 50- μ fd. per section
- C_{12} — Double-spaced 20- μ fd. midgets
- R_1 — 1-meg. vol. control
- R_8 — 0.1-meg. $\frac{1}{2}$ -watt
- R_6 — 240,000-ohm $\frac{1}{2}$ -watt
- R_7 — 10,000-ohm $\frac{1}{2}$ -watt
- R_8 — 3000-ohm $\frac{1}{2}$ -watt
- R_9 — 250,000-ohm $\frac{1}{2}$ -watt
- R_{10} — 50,000-ohm $\frac{1}{2}$ -watt
- R_{11} — $\frac{1}{2}$ -meg. $\frac{1}{2}$ -watt
- R_{12} — 25,000-ohm 20-watt, variable
- R_{13} — 8000-ohm 15-watt

voice peaks, when the d.c. inputs to the modulator and final amplifier are equal, the carrier should be modulated just 100%.

Close switch *Sw* of Fig. 2, and the outfit will be on constant carrier. The exciter is putting around 30 ma. on the grids, and without the

R. F. COIL DATA

Doubling to 20 from 40-Meter Xtal	Tripling to 20 from 60-Meter Xtal	"Straight" from 75-Meter Xtal
L_1 1 1/4" dia. 15 t. No. 22 e.c.	24 turns	
L_2 1 1/4" dia. 8 t. No. 18 e.c., 5 turn tickler	(Other	1 1/2" dia. 30 t. No. 18
L_3 1 1/4" dia. 16 t. No. 18 e.c.	Coils	
L_4 1-turn link over L_3	Same as for	1-turn link over L_3
L_5 2-turn link over L_6	40-meter	2-turn link over L_6
L_6 1 1/2" dia. 12 t. No. 18 e.c.	Xtal)	1 1/2" dia. 30 t. No. 18
L_7 2" dia. 12 t. No. 12 e.c.		3" dia. 28 t. No. 12
L_8 2-turn link, inside L_7		

antenna coupled the plate current is around 20 ma. So couple the dummy antenna load to bring

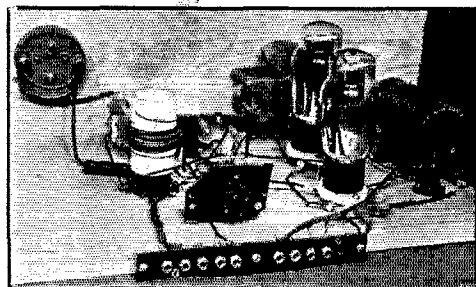

SIMPLE BREAD-BOARD CONSTRUCTION IS USED IN THE CLASS-C AMPLIFIER STAGE, WHICH OPERATES "ALL ABOVE GROUND"

the value to which we adjusted it. The input to the final varies as the square of the plate current, now that the control is in use, and the output of the Class-B modulator will do the same, so over-modulation will be unlikely.

The modulator must use Type 841's or some such high-mu tube. Type 10's will not be as satisfactory. A lower-power version of this outfit could use Type 46's or 59's very nicely, with around half the input, and perhaps 900 volts for

the total plate voltage. The control ratio can be varied by means of the bias to the Class-B modulator, but indications are that about 30-1 is about the best obtainable from the 841 tubes without noticeable distortion.³ It appears that the use of Type 46 tubes would permit a slightly higher ratio to be used.

Another angle to controlled-carrier operation is its advantage with linear amplifiers. When following a controlled-carrier modulated stage,

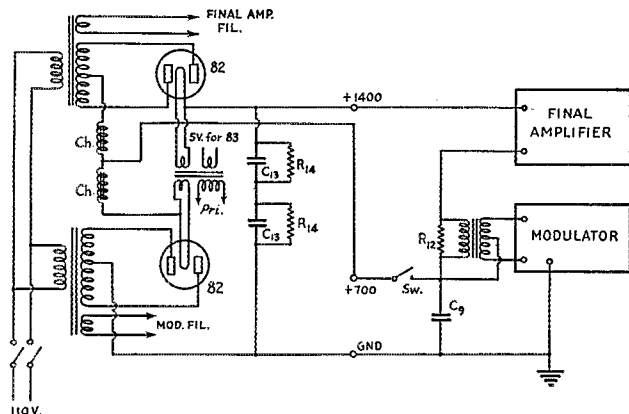

FIG. 3—THE HIGH-VOLTAGE POWER SUPPLY CIRCUIT

C₁₃—8- μ fd. 1000-volt electrolytic
R₁₄—40,000-ohm 20-watt

the linear is no longer tied down by the plate dissipation ratings of the tube. The average efficiency is very much increased, depending to some extent upon the control ratio. In view of the double plate voltage needed, it is doubtful whether this type of carrier control would be economical applied to a very high-power stage. It would probably be more satisfactory to control the carrier at a low level, and follow with a linear amplifier. It looks as though many of the boys will be able to increase their effective power output considerably with little trouble.

I would like to acknowledge the assistance of Mr. George Bird of Brooklyn in the photography in connection with this article.

A New Radio Transmission Phenomenon

(Continued from page 21)

20th, thus confirming the interval between the later occurrences.

Amateur collaboration in further observations on this peculiar fade-out is requested. The next

³ In no case, however, should the modulator be biased beyond cut-off at any input level. The bias should be practically the same as for constant-carrier operation, since the modulator plate voltage with controlled-carrier operation becomes approximately half the total when output is maximum.—Editor.

recurrence of the approximate 54-day period is some time between December 14th and 18th. Although it cannot be foretold in what part of the world it may appear, it will affect daylight high-frequency communication in unmistakable fashion if it occurs. All amateurs are requested to observe carefully, making daytime observations as continuously as practicable, on these dates, and reporting the exact time of any wipe-out noticed, as well as the time signals return, and any other pertinent phenomena. Just drop a letter to the A.R.R.L. Communications Manager at West Hartford. This "Dellinger Effect" is an intriguing thing, and we amateurs can help in its ultimate identification. Two more items:

The sun rotates in about twenty-seven days. Why has the effect been observed only every second solar rotation? It may be merely fortuitous, and it would be desirable to make observations at 27-day intervals. One such mid-period occurs from November 17th to 21st, the next from January 10th to 14th.

Amateurs who conveniently can examine their log for data on possible effects experienced on previous occurrences, are invited to do so. Daylight operation only, of course. It would be particularly helpful to

check on the 27-day mid-period between the 54-day intervals above cited, since no such occurrences are now known and the 54-day period at present seems anomalous.

K. B. W.

Strays

Some apparatus we're curious about (it's all been advertised in ham catalogs):

- the power transformer delivering 600 bolts.
- condenser with plate spacing suitable for low-powdered transmitters.
- an electro dynamite speaker (heavy on the booms!).
- the ultra-short-wave coil form 2 ft. long.
- crystals mounted in modulated Bakelite holders.
- blocking condensers insulated with India rubber mica.
- the receiver in the black-crackled mental case.

Also, we'd like to see some of those car receivers the Boston police are using—according to the newspapers, they use thirty thousand kilowatt high-frequency voltage! To say nothing of the all-mental tubes, mentioned by another paper, which have set W2EBO to wondering if they came as a result of the "Magic Brain!"

H A M D O M

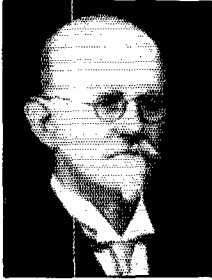

THE mere possession of eight transmitters and more than that number of receivers—even with 600 watts on 4 and 14 mc., 200 watts on 7 mc., and “portable” rigs of 100 watts and 1 kilowatt each—does not make a man a good ham. But Dr. James M. B. Hard, X1G, of Mexico City, has the remaining

qualifying characteristics as well. His early career is striking. He has at various times been interested in ship building, photography (his inventions in this field are still used), histology, bacteriology, and pathology. In 1900 he moved from Orizaba, to Mexico City, a prominent chemist and assayer. Three years later he founded the Hard Chemical Works, one of the largest in the Republic. He started building b.c. and s.w. receivers in 1927, became licensed in 1931. In the succeeding years he has built up a world-wide amateur renown, based both on an outstanding station and an outstanding signal.

ADX man of the highest order and never too busy for traffic is John Stanley Johnson, W4ZH. He started his amateur career in 1930 with the old T.N.T. outfit, has worked 89 countries and is WAC. Fifth in the DX Tests and high man for North Carolina in 1933, he was also a consistent old-time BPL'er. A Mexican Border veteran, graduate of Wake Forest (N. C.) College and the University of North Carolina, W4ZH taught at Cullowhee State Normal and has been at Greensboro High School for the past ten years. He has played semi-pro and pro baseball for Scranton and Rochester and in the Carolina and Virginia Leagues; as high-school baseball coach, he has won two championships and last year grabbed second place. But his biggest thrill is betting some of his DX “Students” he can work more DX on a less “DX’y” band than they—and he usually does it.

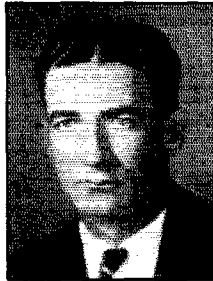

WHEN he has worked 175 countries he will quit and get married. He has 112, now—but don't expect rice prices to boom just yet. He has worked more J's than any other W8, and probably than any other eastern station. His only ambition is greater DX. He has tinkered with radio since 1921; he is now 26. He has no other hobbies. He has many times been found asleep with the cans on and the receiver wide open. He has used the same antenna—an end-fed Hertz—for nine years, but he erected a new 50-foot stick recently. He started with an '01-A Colpitts and B batteries; since then, he has used a '10, '03-A, 852, and now gives a pair of Gammatrons the full kilowatt. His small 8 x 8-foot shack is located almost at the top of a high hill near Cannonsburg, Pa. His name? Surely you've guessed it by now—Frank Lucas, W8CRA, an outstanding DX man if ever there was one.



ROBERT M. SMITH, debonair operator of W9LD and Radiolabs in Kansas City, is a Kansan by birth, education, and inclination. He was born in Ottawa, Kansas, in 1901. Graduating in law from the University of Kansas in 1923, he immediately entered the wholesale dry-goods business. In

1929 he sold out his interest in a large wholesale dry goods firm and entered the radio game. W9LD has been on 20-meter 'phone since the very first authorizations were granted. At present, with a kilowatt to a pair of W. E. 251-A's, high-level modulated with a pair of RCA 851's Class AB, all maintained in an isolated and ideal radio location, his call rings familiarly in most corners of the world. Possessor of a rousing signal, a proficient miniature camera enthusiast, a vice-president of Senders Incorporated, Bob's sole remaining ambition in life is to QRM W6CIN.

A New Receiving System for the Ultra-High Frequencies

Complete Constructional Details of Metal- and Glass-Tube Models

By Ross A. Hull*

In Two Parts—Part II

NOW that we have "shot the works" on the general operating principles and design requirements of the superinfragenerator type of receiver, we may now proceed to talk of purely practical things. For a minute though, we will digress to cover again the basic elements and the terminology used to describe them. The first section of the receiver we will call the first converter. It consists of the pre-selector tube, the first mixer and the first oscillator. The main task of this first converter is to change the signal frequency to what we will term the "low intermediate frequency." The second unit of the receiver—the second converter unit—comprises the selectivity circuits operating on the low intermediate frequency, the second mixer tube and the second oscillator. The purpose of this unit is to change the low intermediate frequency to the "high intermediate frequency." The third section of the receiver we will describe as the superregenerative unit. It consists of the input circuit to the superregenerative final detector, the detector itself, the quench oscillator and the audio frequency amplifier. We reiterate all this simply to keep matters straight. With three detectors, a couple of different intermediate frequencies and miscellaneous oscillators it is just about impossible to describe the system (let alone understand it) without a definite understanding of which detector or oscillator is which.

Our suggestion is that the second and third units of the receiver should be built first. These are the sections in

* Associate Editor, QST.

which unconventional things are done and if the builder is able to get them working satisfactorily he need have no fear about the first converter unit. Fortunately, all the necessary adjustments on the second and third units of the set can be accomplished by using them as a broadcast receiver on the high-frequency end of the broadcast band. By doing this, the various units can be monkeyed with until optimum performance is had even when the test equipment does not include a test oscillator or signal generator. Naturally, it is essential to prepare the mechanical design for the entire set before construction is started.

In both of the receivers to be described, much juggling of shield cans and tubes preceded the decision on layout. The acorn and metal-tube receiver, in particular, was planned for mounting

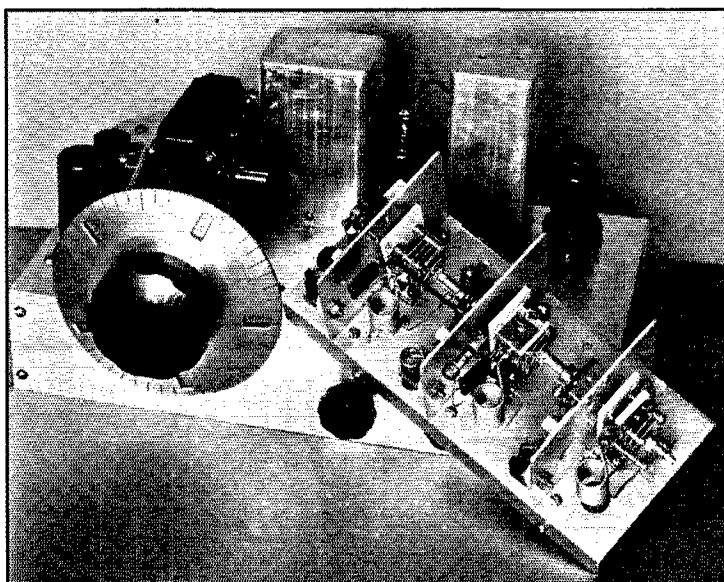

THE TWO UNITS OF THE RECEIVER ASSEMBLY SEPARATED TO ILLUSTRATE THE CONSTRUCTION

The acorn input converter unit is assembled on its own shallow chassis which, in the finished set, is held in position on the main chassis with two long machine screws. In this view the acorn tubes have been removed. The illustration in Part I of this article will be of assistance in following the constructional details. (See November QST.)

on a relay-rack panel, space being allowed for the power pack on the left side of the receiver. This required a quite compact assembly in the receiver itself. Hams unused to cramming much gear in a small space might well expand the dimensions and sacrifice the ability to put the re-

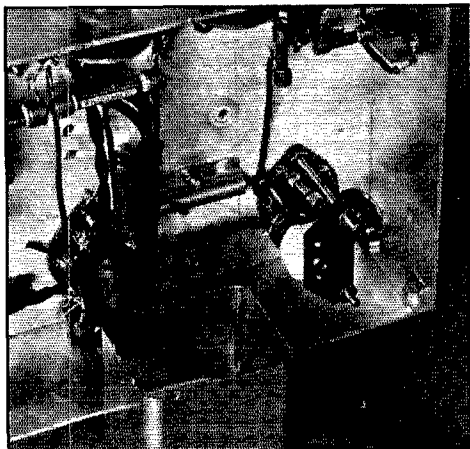

THE SECOND OSCILLATOR ASSEMBLY: A CLOSE-UP VIEW WITH THE SHIELD CAN REMOVED

The tuning inductance, grid leak and grid resistor and plate by-pass condenser are all attached to the tuning condenser itself—the whole assembly being shielded by a can inverted over it.

ceiver and power pack behind a relay-rack panel.

The actual chassis used measures 12 by 6½ by 2¼ inches and is of folded 1/16-inch aluminum. The folding was accomplished by scribing the aluminum deeply at the proposed bend point, then clamping the sheet between two chunks of wood and making the bend by hand. Extra rigidity is obtained by using two similarly-bent end pieces as shown in the under-side view of the receiver.

PLACING COMPONENTS

In the layout of this particular set the first mixer (mounted on the middle partition of the first converter unit) is able to feed directly into the low intermediate frequency transformer mounted immediately behind it. The second oscillator—mounted at the extreme right corner of the set—is reasonably convenient to the second mixer, yet is well removed from the superregenerative detector. Then, the quench oscillator and audio tube are grouped at the left side of the set—the side reserved for placement of the external power pack. Even after a couple of months spent in operating this receiver and studying possible improvements, we can see no very good reason for any substantial departure from this general type of layout. It would be varied somewhat, of course, should an amplifier tube be included at the low intermediate frequency. This design is more

or less built around the National dial, that dial being chosen because it is, without question, the sweetest-working thing we have ever laid hands on (we even enjoy tuning the receiver with the power switched off).

After some reasoning along these lines and some juggling with components, the chassis may be drilled, the various units fixed in place and the set wired.

THE LOW I.F. TRANSFORMER

At the moment of writing, we are unaware of any commercial intermediate-frequency transformer designed for 1500-kc. operation. Hence, it will have to be rebuilt from some existing unit. The transformer in this receiver was originally a Tobe T1 transformer designed for 465 kc. There are three tuned circuits, the inductance element in each case consisting of three pies in series. These pies should be removed from the tubing on which they are mounted. The best scheme, we found, was to cut away the tubing and to unwind it carefully from the inside of the coils. In the final transformer only a single pie is used for each inductance element and these are mounted on a fresh piece of bakelite tube or even wooden dowel. The optimum spacing, as far as we could determine, is about 1½ inches between coils. The selectivity obtained with this three-circuit transformer is sufficient to make most plain modulated oscillators unintelligible.

THE SECOND OSCILLATOR

In the attempt to simplify the harmonic problem in the receiver, the second oscillator was quite fully shielded. The assembly of this oscillator is shown in the close-up view. The tube socket is mounted to the chassis with a pair of threaded brass rods, on the lower end of which is supported a small bakelite piece holding the tuning condenser C_{15} . The coil L_6 together with C_{19} , R_9 and C_{20} are included in this compact assembly. The shield itself is a National Type HRO coil shield cut down to the required height and drilled for attachment to the two threaded rods and for the condenser adjustment screw. The lead from the grid of this oscillator to the 6L7 tube is also shielded with a small piece of folded aluminum. This shield, however, is not essential.

THE SUPERREGENERATIVE CIRCUIT

The large shield can (HRO type) located near the rear center of the receiver contains the coils L_8 and L_7 , the tuning condenser C_{16} and the grid condenser and leak C_{22} and R_{14} . The Hammarlund tuning condenser is mounted on the chassis with its adjustment screw projecting underneath. The coils and other components are mounted directly on this condenser. The shield is then readily inverted over the assembly and secured with the lugs projecting through the chassis.

The grid coil L_7 is a self-supporting type coil while the primary is wound on a piece of half-inch diameter bakelite or R39 tubing. The adjustment of this primary with respect to the grid coil is very important. It will be given treatment later. After adjustment, the primary is wedged into place with a couple of small slivers of bakelite and made secure with a few drops of Duco cement. The tap on L_7 is also very important but the adjustment cannot be made until the unit is placed in operation.

THE FIRST CONVERTER UNIT

The acorn input unit is assembled and wired on its own small chassis. This process actually simplifies construction and wiring and provides greater flexibility with respect to possible future modification.

The chassis of this unit is also of folded 1/16-inch aluminum and measures $7\frac{3}{4}$ by $3\frac{1}{2}$ by $\frac{7}{8}$ inches. The latter dimension is required in order to bring the shaft of the tuning condenser gang in line with the shaft of the National dial. The three partitions measure $2\frac{3}{4}$ by $3\frac{1}{2}$ inches (not including the bend at the bottom for attachment). The three Hammarlund or National acorn tube sockets are mounted on the partition. The tuning condensers are mounted on the chassis itself, the partition being drilled to pass the drive shaft. The coils are soldered directly to the lugs on the tuning condensers, but if provision for coil changing is required, some appropriate pin-jack could be provided.

The dust cover for this assembly is of folded 1/32-inch aluminum. Its lower edges are slotted so that it may be slipped under the heads of machine screws threaded into the chassis.

THE WIRING ARRANGEMENT

In planning the circuit, an attempt was made to avoid anything freaky. "Simplification" of the set by using double-purpose tubes was avoided even though that procedure might have reduced the total number of tubes employed. Our experience has indicated that the use of double-purpose tubes very frequently leads to serious circuit complications and adjustment difficulties. Probably the only portion of the circuit not readily understandable at first glance is that of the quench oscillator. This oscillator is of the "grounded grid" variety, so arranged as to allow the screen by-pass condenser C_{23} to serve also as a tuning condenser across both coils (L_8 and L_9) of the quench oscillator. The first and second oscillators are both of the grounded plate type originally described in April 1932 *QST*. The remaining unconventional section is the quench frequency filter L_{10} , C_{29} and C_{30} . This is a series-resonant circuit connected across the output of the superregenerative detector to prevent the audio tube from being overloaded by quench voltage.

In the first converter unit most of the wiring is above the chassis. Needless to say, all wires carrying r.f. are made as short and direct as possible. No special precautions were found necessary to prevent oscillation in the pre-selector other than the usual business of running by-pass condensers to a single point on the chassis.

The wiring of the second converter unit and the superregenerative section is conventional in every respect. The only important point is to make certain that no wires carrying r.f. and associated with the second oscillator should be permitted to run in close proximity to the input

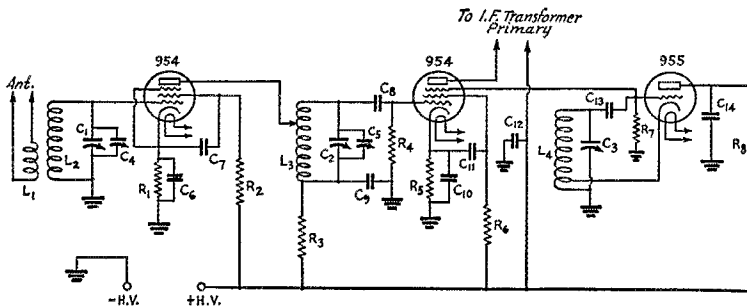

FIG. 1—WIRING OF THE ACRN INPUT UNIT OF THE SUPERINFRAGENERATOR RECEIVER

- L_1 —Seven turns of No. 15 enamelled wire $\frac{1}{2}$ -inch inside diameter. Very slight spacing between turns.
- $L_2, 3, 4$ —Each eight turns of No. 14 bare or tinned wire $\frac{1}{2}$ -inch inside diameter with turns spaced to occupy one inch. The best position for the plate tap on L_2 is usually 3 or 4 turns down from the grid end of the coil. Cathode tap on L_4 at $1\frac{1}{2}$ or 2 turns from the grounded end of coil. These coils are for 56-mc. operation.
- $C_1, 2, 3$ —National Type UMA condensers with four stator and five rotor plates. These are unnecessarily large for the 56- to 60-mc. band but give convenient coverage of about 4 mc. on each side of the amateur band.
- $C_4, 5$ —National Type M30 padding condensers. (Max. capacity 30 $\mu\text{fds.}$)

- $C_6, 7$ —500 $\mu\text{f.}$ fixed midget condensers.
- C_8 —100 $\mu\text{f.}$ fixed midget condenser.
- C_9 —500 $\mu\text{f.}$ fixed midget.
- $C_{10}, 11, 12$ —.01 $\mu\text{f.}$ 400-volt paper-type condensers. C_1 may be low-voltage type.
- C_{13} —100 $\mu\text{f.}$ fixed midget condenser.
- C_{14} —1000 $\mu\text{f.}$ fixed midget.
- R_1 —1500-ohm half-watt fixed resistor.
- R_2 —100,000-ohm half-watt fixed resistor.
- R_3 —2000-ohm half-watt fixed resistor.
- R_4 —1-megohm half-watt fixed resistor.
- R_5 —2000-ohm half-watt fixed resistor.
- R_6 —100,000-ohm half-watt fixed resistor.
- R_7 —50,000-ohm half-watt fixed resistor.
- R_8 —100,000-ohm half-watt fixed resistor.

wiring of the superregenerative detector. It should be noted that the quench-frequency filter was not installed in the receiver at the time the view of the under side was taken. Its location is of no great importance and there are plenty of vacant spaces available for the necessary choke and tuning condensers. Not shown in the diagram is a small toggle switch included in the positive high-voltage supply lead. Such a switch is invaluable

the superregenerative detector tube, its quench oscillator and the audio tube. The third detector should superregenerate very readily since there is no load on its grid circuit. For this preliminary check the cathode tap on L_7 might well be two or three turns up from the grounded end of the coil. At this stage, the 6L7 second converter and the second oscillator may be plugged into their sockets. This will immediately impose a load on

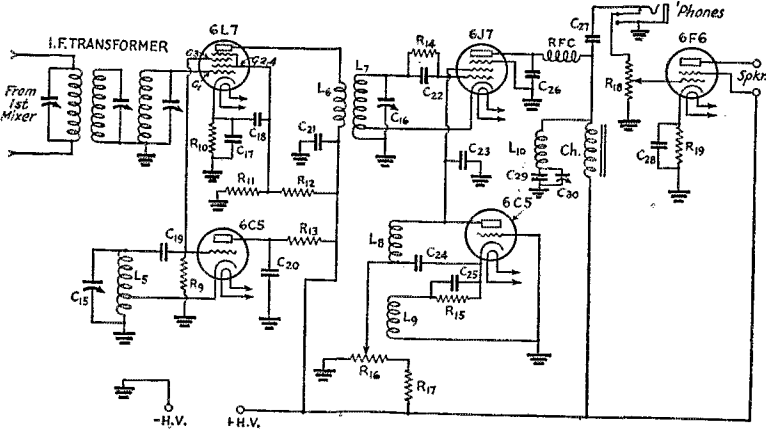

FIG. 2—THE WIRING OF THE INTERMEDIATE-FREQUENCY SECTION

- L_5 —Eight close-wound turns of No. 22 double-silk-covered wire on a $\frac{1}{2}$ -inch diameter former. A National R39 former of this size was used in the original set. Cathode tap is 2 turns up from the grounded end of coil.
- L_6 —Twenty-close-wound turns of No. 30 d.s.c. wire on a National $\frac{1}{4}$ -inch diameter R39 coil form. This coil is wedged into L_7 with small pieces of celluloid and the assembly made firm with "Duco" cement or acetone. See text for details of adjustment.
- L_7 —Ten turns of No. 14 bare or tinned wire $\frac{3}{4}$ -inch inside diameter with turns spaced diameter of wire. Cathode tap at about third turn from grounded end.
- $L_8, 9$ —Windings of National quench oscillator unit. Improved performance is had in this circuit by using the small coil in the grid circuit. The "P" lug is therefore connected to the tube grid, the "G" terminal going to the tube plate.
- $C_{15, 16}$ —Hammarlund AT75 75 μ fd.
- C_{17} —.01 μ fd. 200-volt paper-type condenser.
- C_{18} —.01 μ fd. 400-volt paper-type condenser.
- C_{19} —100 μ fd. fixed midget condenser.
- C_{20} —1000 μ fd. fixed midget.
- C_{21} —.01 μ fd. 400-volt paper-type condenser.
- C_{22} —100 μ fd. midget fixed condenser.
- C_{23} —.002 μ fd. fixed midget condenser.

- C_{24} —.1 μ fd. 400-volt paper-type condenser.
 - C_{25} —.1 μ fd. low-voltage paper-type condenser.
 - C_{26} —1000 μ fd. fixed midget.
 - C_{27} —.1 μ fd. 400-volt paper-type condenser.
 - C_{28} —10 μ fd. electrolytic condenser.
 - R_9 —50,000-ohm half-watt resistor.
 - R_{10} —350-ohm half-watt resistor.
 - R_{11} —50,000-ohm 1-watt resistor.
 - R_{12} —15,000-ohm 2-watt resistor.
 - R_{13} —100,000-ohm half-watt resistor.
 - R_{14} —5-megohm half-watt resistor.
 - R_{15} —2000-ohm half-watt resistor.
 - R_{16} —100,000-ohm potentiometer.
 - R_{17} —50,000-ohm half-watt resistor.
 - R_{18} —500,000-ohm potentiometer.
 - R_{19} —600-ohm 5-watt resistor.
- I.F. Transformer—See text for details.
R.F.C.—National Type R90 choke.

L_{10}, C_{29} and C_{30} comprise the quench frequency filter—a very desirable but not essential addition. L_{10} is a National Type R90 choke (90 millihenrys). C_{30} is a 150 μ fd. or larger mica padding condenser while C_{29} is a fixed condenser of 250 μ fd. The filter is tuned with a rectifier type voltmeter across the output of the set until minimum reading is obtained with no signal input to the set. C_{15} and L_8 are mounted on the oscillator tube socket and covered with a small shield can.

both during the adjustment and checking of the receiver, and during normal operation.

ADJUSTMENT PROCEDURE

Just as soon as the wiring has been checked over half a dozen times, an attempt may be made to get the second and third units of the receiver into operation. The power pack will be required to deliver the usual 6.3 volts for the heaters and about 230 volts at about 50 milliamperes for the plates. We found it convenient to disconnect the first converter unit during the adjustment of the remainder of the set. The first step is to insert

the superregenerative detector and will call for an increase of the voltage supplied from R_{16} in order to maintain the superregenerative condition. Before going very far, however, the second oscillator tuning condenser C_{15} should be varied in order to determine whether or not this oscillator can be tuned to the same frequency as the superregenerative detector. This detector will be blocked up tight when the second oscillator frequency coincides with its own.

The next step is to detune the second oscillator by approximately 1500 kc. from the frequency on which the superregenerative detector is operating.

This may be accomplished by connecting an antenna through a condenser of 2 or 3 $\mu\text{fd.}$ to the grid of the 6L7 then varying C_{15} until a broadcast signal toward the high-frequency end of the broadcast band is heard. The difference-frequency between the second oscillator and the third detector may then be determined by identifying the broadcast station. Usually, under these conditions, the sensitivity of the receiver is very great and it should be possible to pick up many miscellaneous signals. The receiver will, of course, be extremely broad and the operator should not be alarmed to find half a dozen broadcast stations on top of each other.

A weak broadcast signal near the high-frequency end of the broadcast band may now serve to allow tuning of the intermediate-frequency transformer. The antenna should be connected through a very small capacity to the input winding of the transformer. Then, the i.f. transformer may be tuned until maximum response is had from the broadcast signal. Naturally, a modulated test oscillator is very convenient for this job. Now comes the very important job of adjusting the coupling between L_6 and L_7 . This coupling should be very tight and should be increased bit by bit (retuning C_{15} with every change) until the third detector will just superregenerate over the last few degrees of the potentiometer R_{16} . It is possible, however, to get excessive coupling at this point. Such a condition will not allow the second oscillator to be tuned to a frequency 1500 kc. different from that of the third detector. Careful experiment and adjustment is essential.

It will be found that the broadcast station or test oscillator signal may be received at two different settings of C_{15} —one when the second oscillator frequency is 1500 kc. lower than that of the third detector, the other when the second oscillator is the same amount higher in frequency

than the third detector. Usually, one of these settings will be slightly better than the other.

Now comes the final clean-up. We have so far only tuned the second and third circuits of the intermediate frequency transformer. The tuning of the primary may be made just as soon as the input converter is connected and adjusted. The

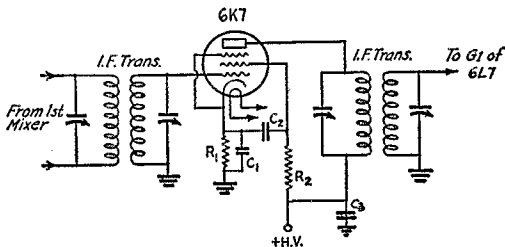

FIG. 4—WIRING OF THE SUGGESTED I.F. AMPLIFIER

R_1 —350-ohm half-watt resistor.
 R_2 —100,000-ohm half-watt resistor.
 $C_1, 2, 3$ — $.01 \mu\text{fd.}$ paper-type condensers.

flexible coupling between the three condensers of the input converter tuner should be loosened and the antenna connected to L_1 . Slow rotation of the oscillator condenser should reveal two spots where the background noise increases. Should the location be a particularly quiet one, it may be advisable to set up a modulated test oscillator on 56 mc., or even a superregenerative receiver functioning as a test oscillator. The idea, in any case, is merely to provide some signal or noise on which to line up the pre-selector and oscillator with respect to the first detector. If the three coils of this unit are all identical, it should be readily possible to locate the higher of the two possible settings of the oscillator tuning condenser (the lower capacity setting).

Now, the three condensers should be hitched together with their couplings and the same signal recovered by adjustment of the trimmers C_4, C_5 . This arrangement of trimming does not allow perfect tracking across any wide range of frequency. However, it is ample for coverage of the 56–60 mc. band.

During all this adjustment of the first converter, or after it, the primary of the intermediate frequency transformer may be tuned and its other circuits re-trimmed.

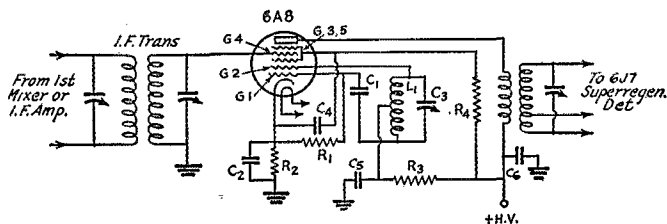

FIG. 3—A SUGGESTED CIRCUIT FOR THE 6A8 CONVERTER

R_1 —50,000-ohm half-watt resistor.
 R_2 —250-ohm half-watt resistor.
 R_3 —20,000-ohm half-watt resistor.
 R_4 —50,000-ohm half-watt resistor.
 C_1 —100 $\mu\text{fd.}$ midget condenser.
 C_2 — $.01 \mu\text{fd.}$ paper-type condenser.
 C_3 —75 $\mu\text{fd.}$ oscillator tuning condenser.
 C_4 — $.01 \mu\text{fd.}$ paper-type condenser.
 C_5 — $.001 \mu\text{fd.}$ midget condenser.
 C_6 — $.01 \mu\text{fd.}$ paper-type condenser.
 L_1 —Eight close-wound turns of No. 22 d.s.c. wire on half-inch diameter former. Tap at approximately the center of coil.

SETTING THE HIGH INTERMEDIATE FREQUENCY

As outlined in the first part of this article, the choice of a suitable high intermediate frequency is very important if trouble from harmonic interference or "birdies" is to be avoided. The best procedure, of course, is to measure this frequency with a wavemeter. Since few amateurs are likely to possess meters tuning in this range, it will

usually be necessary to accomplish the tuning by cut and try. The general procedure is to find a high i.f. which will produce no serious beat as the receiver is tuned across the band. When a strong

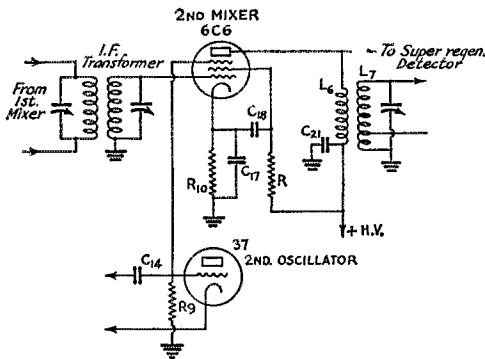
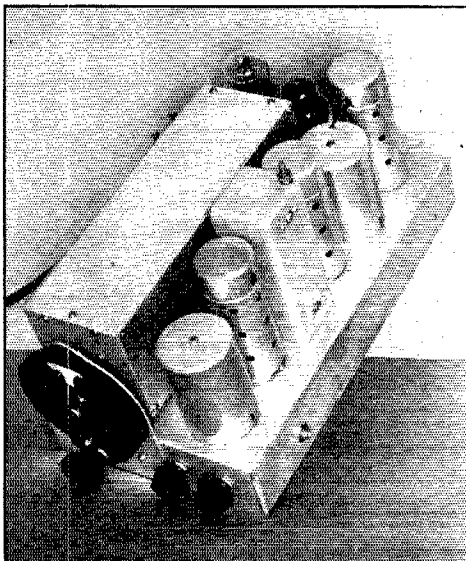

FIG. 5—THE CIRCUIT OF THE SECOND MIXER IN THE GLASS-TUBE RECEIVER

The resistor R is a $\frac{1}{2}$ -watt .1-megohm unit. The remaining components are the same as those specified in the circuit of the metal-tube receiver with the exception of the i.f. transformer which is discussed in the text.

beat is located somewhere within the limits of the band, C_{15} and C_{16} are both turned in the same direction by a slight amount, the test oscillator signal recovered and a further search made for the beats. Two or three tests of this type will soon reveal the direction in which the interfering beats are moving and will indicate the direction in



THE GLASS-TUBE MODEL: A GENERAL VIEW

While the mechanical arrangement of this receiver differs somewhat from the metal-tube model, the circuit arrangement is almost exactly the same. Needless to say, a sporty panel would be a help

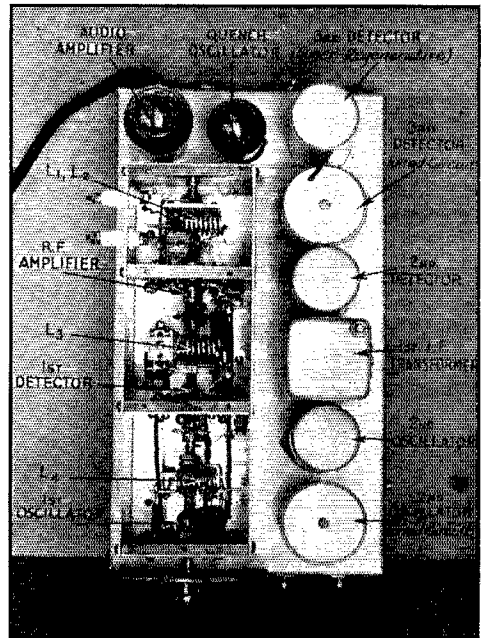

THE GLASS-TUBE MODEL: A PLAN VIEW WITH THE COVER OF THE INPUT CONVERTER UNIT REMOVED

The shield box of the input converter is built up from 1/16-inch aluminum and 1/4-inch square brass rod. This type of construction is considerably more difficult than that used in the metal-tube set. Obviously, the input converter units of the two receivers, chassis space permitting, are interchangeable.

which C_{15} and C_{16} should be tuned in order to place the beats beyond the tuning range of the receiver. The high intermediate frequency used in the receiver illustrated is approximately 22.5 mc.

POSSIBLE MODIFICATIONS

While we do not recommend the use of double-purpose tubes in the usual instance, it is obviously possible for the advanced worker to use a Type 6A8 tube as the second converter—so avoiding the use of a separate tube for the second oscillator. A suggested circuit of the 6A8 is given.

Another modification is the addition of an i.f. amplifier operating at the low intermediate frequency. Such an amplifier would be essential in a receiver using the conventional glass or metal tubes in the first converter section and would be desirable in a receiver intended for operation on 112 and 224 mc. This amplifier could be used in conjunction with a pair of double-tuned i.f. transformers and could be connected in accordance with the circuit given.

THE GLASS-TUBE MODEL

The glass-tube model is presented as an example of one satisfactory layout. The receiver

illustrated was a predecessor of the metal-tube version but suffers very little in comparison with the latter set. The input converter of the glass-tube receiver differs somewhat in its mechanical arrangement from the input converter of the metal-tube rig, but the circuit and constants are the same. Likewise, the circuit of the remaining portions of the receiver is the same as that already given, with the exception of the second

into which several different transformers could be plugged to suit the requirements of the moment.

OPERATING CONSIDERATIONS

Both of the receivers illustrated have been given a thorough run both in the laboratory and in routine ham communication. The measured sensitivity of the metal-tube receiver is slightly greater than that of the glass-tube model but their performance under normal operating conditions is substantially the same. In neither case is it possible to use the receivers "full out" and listen to the result in comfort. The selectivity of the glass-tube model is naturally less than that of its brother, but with both receivers the now old-fashioned, unstabilized modulated-oscillator transmitter is virtually incapable of producing a readable signal. Signals from well-adjusted short-line controlled oscillators are, however, of good quality. These receivers (or any selective receivers for that matter) discriminate against frequency modulated signals and a comparison with the straight superregenerator in this respect

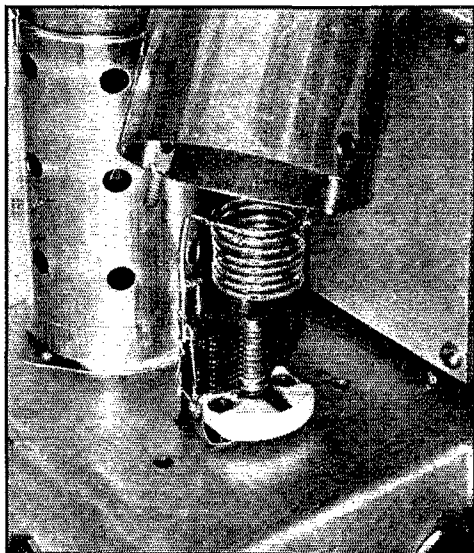

ILLUSTRATING THE SECOND OSCILLATOR COIL ASSEMBLY IN THE GLASS-TUBE RECEIVER

This type of assembly, with the coil attached directly to the lugs of the tuning condenser is also used for the detector input circuit of both receivers—the primary winding being wedged inside the secondary or grid coil.

mixer. The arrangement of the 6C6 tube in this position is given in Fig. 5. It is a conventional mixer with suppressor-grid injection. The other tubes in the glass-tube model are Type 37 for the second oscillator and quench oscillator; 6D6 for the superregenerative detector and 42 for the audio stage. The coil assemblies and the values of all other components are the same in both receivers. The remaining difference is in the intermediate frequency transformer. This unit is a rebuilt Hammarlund variable selectivity transformer in which a single pie is used in place of three pies originally provided. The small tuning range of the condensers in the transformer unit will make it necessary to remove a few turns from each pie in order to reach 1500 kc. Of course, there is no reason why the three-circuit transformer used in the metal receiver should not be employed in this case also, should the higher order of selectivity be desirable and should the variable selectivity feature be considered unimportant. The right idea would be to fit the chassis with some G.R. jacks

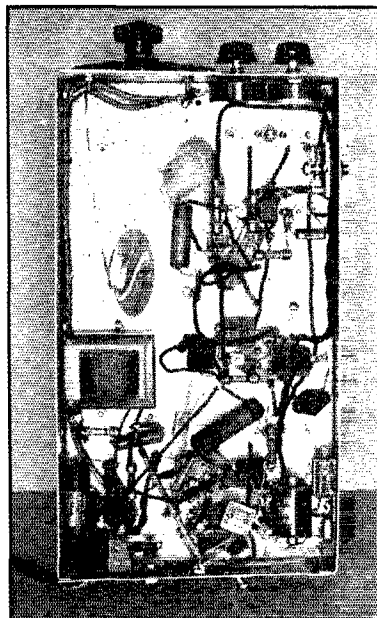

THE UNDERSIDE OF THE GLASS-TUBE RECEIVER

The construction of this set preceded the metal-tube model as is evidenced by the helter-skelter wiring. The chassis is a standard steel unit of the type available in many radio stores. It measures 13 by 7 by 2 inches.

is interesting. A very badly frequency-modulated signal, aside from being unreadable on the new receivers, is usually of no greater strength than with the straight superregenerator. On the other hand, we have run into many instances where

(Continued on page 98)

3500- to 4000-Kc. Transoceanic Tests

December 14-22, 1935

By H. J. Powditch, G5VL**

A SERIES of transoceanic tests using the 3500- to 4000-kc. band of frequencies has been arranged during December 1935, the R.S.G.B. making arrangements and obtaining full coöperation of European amateur societies and A.R.R.L.

It is hoped that great DX possibilities will be realized and that greater DX use of this band will result—to the benefit of all interested in amateur work. Many of the pioneer transoceanic contacts were made on neighboring frequencies and, after ten years' experience, the return to good conditions and equipment as well should assure real results.

To obtain satisfactory results during the test period all stations are urged strongly to follow the suggested arrangements to reduce QRM and permit DX working. If the low frequency end of the band is kept for C.W. work only, this will give a better chance and avoid phone QRM on weak signals.

The "Silent Periods" are to give all an opportunity to locate and log DX signals, impossible otherwise. The observance of these periods is very important. The test is divided into two series of four days each, with different time periods to allow many who cannot operate at a particular time to get in on the other schedule. All hams are invited to take part in both series. All European Societies have been asked to coöperate.

The "silent" or listening periods must be kept. They will give a unique opportunity for logging. European stations (including the G's) do not transmit for the first 15 minutes of each period, concentrating upon logging the "test" calls heard from W's and VE's. For the following 15 minutes W/VE's are silent and Europe calls "test" with a view to getting heard and logged. After this, it is purely two-way working for the rest of each period. The arrangement to use two different times for each half-week is to suit those who may not be able to fit in one or the other. It will also give some comparison of results, with the hoped for reduction in QRM, between midnight and morning conditions. From 00.15 to 02, the air is free for all stations to establish contacts in both directions. The same procedure holds for the second series, starting the cycle at 05 in place of 23.45, GT.

DATES.—First Series: December 15th, 16th,

* December 19th, 20th, 21st, 22nd.

** Perth, St. Columb Minor, Cornwall, England.

17th, 18th (Starting 23.45 GT December 14th); Second Series: December 19th, 20th, 21st, 22nd.

All stations, everywhere, using 3500- to 4000-kc. transmitters, are urged to take part in the tests, and, in any event to coöperate, first in observing the 15-minute silent period specified above for the test dates. Second, transmit in the transmitting period, attempting two-way QSO's in the longer interval that follows. Third, report your results!

This test has been arranged at the best hours for transatlantic working so that maximum possibility of successful DX work exists for all groups of phone and telegraphing amateurs. Coöperation pays big dividends in results. Do your part.

FREQUENCIES.—To assist searching and minimize QRM all stations are asked to observe the following frequency allocations:

3900 to 4000 kc. American and Canadian phone.

3850 to 3900 kc. Canadian phone.

3730 to 3850 kc. W/VE C.W.; European phone and C.W.—except British stations.

3630 to 3730 kc. British phone.

3500 to 3630 kc. W/VE C.W.; European (including British) C.W. ONLY. It is hoped that phone stations will leave these frequencies clear for low power and DX C.W.

American and other C.W. stations, outside Europe, have the choice of 3730/3850 kc. and 3500/3630 kc.

LISTENING PERIODS.—All stations, during the listening periods, should call "TEST RSGB de." giving their own call signs very frequently. After the second listening period, that is the European transmitting period, European stations should run through the dial for calls before going on the air themselves.

Send W/VE reports to A.R.R.L. and we shall forward them all across the water together for you. All European reports and those from other continents than North America should be sent direct to G5VL.

European societies are enthusiastically lending coöperation in the tests, and it is hoped that new DX records will be established on this band, the one on which so much pioneer transatlantic work was accomplished. The German society, the D.A.S.D., have published the announcement of the tests in CQ-MB, and are halting all intra-German amateur communication schedules on this band for the period of the tests. The R.E.F.

TIME TABLE

1st Series, Dec. 15, 16, 17, 18					
	GMT	EST	CST	MST	PST
	Starts (Dec. 14, 15, 16, 17)	(Dec. 14, 15, 16, 17)			
Europe keeps silent.....	2345-2400	6:45-7:00 p.m.	5:45-6:00 p.m.	4:45-5:00 p.m.	3:45-4:00 p.m.
W/VE keeps silent.....	0000-0015	7:00-7:15 p.m.	6:00-6:15 p.m.	5:00-5:15 p.m.	4:00-4:15 p.m.
Transmitting..... (all stations)	0015-0020	7:15-9:00 p.m.	6:15-8:00 p.m.	5:15-7:00 p.m.	4:15-6:00 p.m.
2nd Series, Dec. 19, 20, 21, 22					
		(Dec. 18, 19, 20, 21)			
Europe keeps silent.....	0500-0515	00:00*-12:15*a.m.	11:00-11:15 p.m.	10:00-10:15 p.m.	9:00- 9:15 p.m.
W/VE keeps silent.....	0515-0530	12:15*-12:30*a.m.	11:15-11:30 p.m.	10:15-10:30 p.m.	9:15- 9:30 p.m.
Transmitting..... (all stations)	0530-0800	12:30*- 3:00*a.m.	11:30 p.m.-2:00* a.m.	10:30p.m.-1:00*a.m.	9:30-12 p.m.

(France) has promised publicity and support and PAØASD reports that he and all European amateurs seem keen for the revival of 80-meter DX working. As reported elsewhere in this QST, United States hams have since October been making two-way contacts with VK's and ZL's on

this band, and everything looks bright for world wide contacts during the December 80-meter band tests. QST will report the contest results as fully as possible. All readers are asked to report the stations heard and worked in full for the contest periods given. Good luck, all.

A.R.R.L. QSL Bureau

FOR the convenience of its members, the League maintains a QSL-card forwarding system which operates through volunteer "District QSL Managers" in each of the nine U. S. and five Canadian districts. In order to secure such foreign cards as may be received for you, send your district manager a standard No. 8 stamped envelope. If you have reason to expect a considerable number of cards, put on an extra stamp so that it has a total of six-cents postage. Your own name and address go in the customary place on the face, and your station call should be printed prominently in the upper left-hand corner. When you receive cards, you should immediately furnish your QSL manager with another such envelope to replace the used one.

W1—J. T. Steiger, W1BGY, 35 Call Street, Willimansett, Mass.

W2—H. W. Yahnel, W2SN, Lake Ave., Helmetta, N. J.

W3—R. E. Macomber, W3CZE, 418 10th St., N. W., Washington, D. C.

W4—B. W. Benning, W4CBY, 520 Whiteford Ave., Atlanta, Ga.

W5—E. H. Treadaway, W5DKR, 2749 Myrtle St., New Orleans, La.

W6—C. E. Spitz, W6FZQ, Box 1804, Phoenix, Ariz.

W7—L. Q. Kelly, W7BPC, 4919 So. Prospect St., Tacoma, Wash.

W8—F. W. Allen, W8GER, 324 Richmond Ave., Dayton, Ohio

W9—George Dammann, W9JO, 319 Sherman Ave., Evanston, Ill.

VE1—J. E. Roue, VE1FB, 84 Spring Garden Rd., Halifax, N. S.

VE2—W. H. Oke, VE2AH, 5184 Mountain Sights Ave., N. D. G., Montreal, P. Q.

VE3—Bert Knowles, VE3QB, Lanark, Ont.

VE4—Dr. J. J. Dobry, VE4DR, Killam, Alberta.

VE5—E. H. Cooper, VE5EC, 2024 Carnarvon St., Victoria, B. C.

K4—F. McCown, K4RJ, Family Court 7, Santurce, Puerto Rico.

K7—Frank P. Barnes, K7DVF, Box 297 Wrangell, Alaska.

Strays

W8KPL claims to be the only ham having a "bluffer" stage—a defunct 50-watt pretending to work alongside a 10 in the final!

QST Index (1935) Now Available

The annual index to QST for 1935 (Volume XIX) has been published as part of this issue, and sent to every member of the League. Newsstand readers may obtain a copy of this index for 6 cents in stamps.

The Young Squirt's Fourth Epistle to the Old Man

WELL, you old mossbacked greybeard, I ain't been hearing much from you of late, and I about decided that you ain't finding nothing rotten to yell about. Guess the game is too fast for you. Putting that infernal old Betsy up in the attic along with all the other relics must have put the skids under you. I hope so. I bet you ain't even got up a stick.

They ain't nothing wrong with radio now, I guess. The only thing that ever was wrong was giving space in *QST* to those snorts and bellows of yours. That Wouff Hong you sent Eddie Warner hasn't been down off the wall since 1921. That's a pretty good sign, ain't it, old Methusalem? Since you quit blowing the pole transformer every Saturday night and making sparks hop across inside my Audiotron, the game has become jake for me, and if you never get back on the air again, that will be too soon. You went out just like a Swedish match in a Kansas hurricane as soon as CW come along, and that is one reason CW is such an improvement.

I been thinking about you ever since the other night. There was something mighty gosh-darned suspicious that has been worrying me, and the more I think about it the madder I get until I could bite a plug out of a nine-foot rattlesnake. You never was able to pull the wool over my eyes none, you old petrified fossil.

One of these Old Timers dropped in the other night while I was throwing the works to my bottle. The glow from my plate, which showed it was working good, causes this Pelican to get off a few wise yelps about power output. According to him, the only fellows who know anything about getting the high-powered snorts out of a jug were graduated from spark. This didn't get no rise out of me because I had a squeak box with an E. I. Co. electrolytic interrupter, as you well remember, but his next remark made me sore enough to kick the step-ins off of a tree full of wildcats. He ups and says that since the old timers are coming back in the game it is getting better, and that all it needs to be a hunnered percent is for the Old Man to get back in so there will be law and order. Just as soon as he said that, everything turns red in front of me and I bit the wrong end off my El Ropo, which didn't help to calm me down none.

When that happens, I says, I am going to move to Siberia. This oily lamp raises his eyebrows and says that would be the right place for mosquitos who use bug keys on red-hot plates. I inferred by that he was talking about me, since I had been

holding my dot lever closed while doing some testing, which made my signals sound commercial. I began right away to feel heat radiating out of every pore, and quick as a 28-megacycle oscillation I yelled back you are a visitor around here

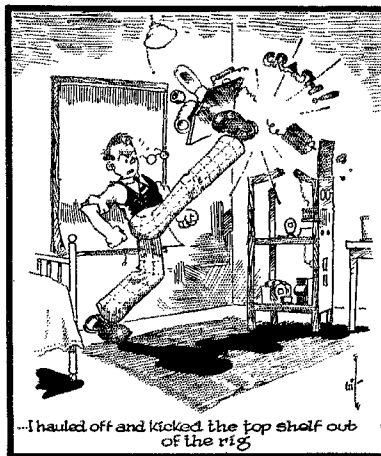

otherwise I would lose no time in telling you the right place for you to go, and at this he grates out a laugh, and his eyebrows wiggled up and down just like yours did when I used to get off a rejoiner you couldn't think up no reply to.

How come, he says, you are using no filter on this haywire? Do you think just because the Old Man is not arrund close that you can get by with that? I let out a yell, I was so mad. Who do you think you are, I screamed, I can comb the burrs out of that old dingfritter's foliage any time he comes around. Oh, yeah, son? he grunts, wiggling his eyebrows up and down rapid, them are large words for a little gnat like you. The Old Man would waste no time immersing your hide in some good hot transformer oil.

At this I hauled off and kicked the top shelf out of the rig. You are talking so big, take off that overcoat and that muffler you got wrapped around yore gills so I can have more area to plaster, you desiccated sardine, I yelled. He laughed sarcastic. You forget I am a visitor, he said. One well-directed Rettysnitch takes all the sap out of little horseflies like you, and I am going to watch you pretty close from now on.

At this point I began to roll around on the floor to calm myself, meanwhile kicking a pair of 866's

(Continued on page 102)

for the EXPERIMENTER



A "Fly-Power" 'Phone Transmitter Using a 6A7

Two circuits suggested by Leonard Tulauskas, W9LKV, for using a 6A7 tube as a crystal oscillator with modulation applied to the inner grid, are shown in Fig. 1. The upper circuit is for operation at the crystal frequency, while the lower is for obtaining output at the second harmonic of the

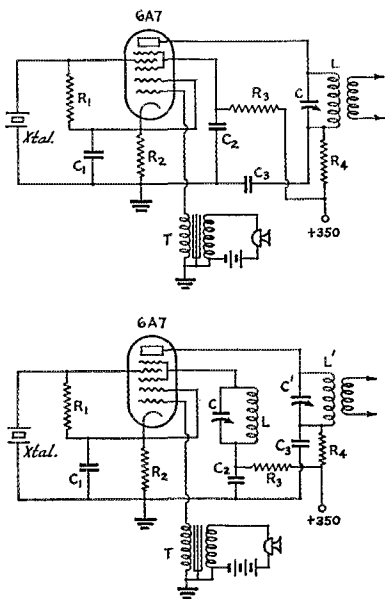

FIG. 1—SINGLE-TUBE CRYSTAL-CONTROLLED 'PHONE TRANSMITTER USING A 6A7

- R₁—500,000 ohms.
- R₂—1000 ohms.
- R₃—40,000 ohms.
- R₄—1000 ohms.
- T—Single-button microphone transformer.
- C₁—1 μfd.
- C₂, C₃—.01 μfd.
- C, L—To tune to crystal frequency.
- C', L'—To tune to second harmonic of crystal.

crystal. In the latter case a circuit tuned to the crystal fundamental is inserted in the screen (grids Nos. 3 and 5) lead, the plate circuit being tuned to twice the crystal frequency. The ordinary single-button mike and transformer will have high enough voltage output to modulate completely the output of the oscillator.

W9LKV writes that no frequency modulation is detectable so long as the plate current of the oscillator does not change with modulation. These circuits have been used very successfully for short-distance work on the 160-meter band, using an input of less than three watts to the tube. They should be of interest to the amateur who wants an inexpensive low-power rig for local work or for portable use.

REGENERATIVE AMPLIFICATION AT SIGNAL FREQUENCY

Additional sensitivity and selectivity may be obtained at the cost of slight inconvenience by the use of a regenerative receiver having no radio frequency amplification, when used in conjunc-

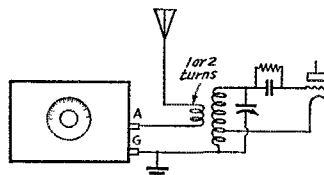

FIG. 2—USING A REGENERATIVE DETECTOR AS A SIGNAL-FREQUENCY BOOSTER FOR AN AMATEUR-BAND SUPERHET

No constructional changes in either superhet or regenerative detector are required.

tion with regular superheterodyne receiving equipment. That there is need of such sensitivity upon many occasions will be generally recognized.

We are familiar with the re-radiating qualities of a regenerative receiver of the type specified. The gain in sensitivity is obtained because of that quality.

The procedure is as follows: Disconnect the antenna from your regular receiver and introduce the regenerative receiver between the antenna and the antenna post of the regular receiver. The antenna is connected to the antenna post of the regenerative receiver and the ground terminal of the regenerative receiver is connected to the antenna post of the regular receiver. Let the assumption be that an 80-meter signal had been tuned in prior to the introduction of the regenerative receiver. The next step will be to tune in that 80-meter signal on the regenerative receiver and it will be noticed that a very decided gain in signal strength is obtained.

Another method is to introduce an old regenerative b.c. tuner, such as the Radiola III, for instance, in the lead from an s.w. converter to the antenna post of a broadcast receiver used as an i.f. amplifier. The result is the same but the inconvenience is not so great, since the regenerative set need be tuned only once.

Other applications also may suggest themselves.

—Leonard C. Jensen, *W1IW*

EDITOR'S NOTE.—This scheme has excellent possibilities for increasing the amplification and providing signal-frequency selectivity with amateur-band superhets having no pre-selection. Its chief advantage is the fact that a discarded regenerative receiver (most ham stations have one) can be used without the necessity for even slight changes in the wiring of the superhet receiver.

Fig. 2 shows how the method has been used successfully with a receiver of the FB-7 type using the detector of the two-tube receiver described in June 1934 *QST* as the regenerative signal booster. Although the ground post on the regenerative set can be connected to antenna on the super and the antenna run to the antenna post on the regenerative set, as suggested by *W1IW*, it has been found preferable to connect the ground posts of the two receivers together and couple the antenna lead to the regenerative tube through a turn or two around the detector coil as shown. This "ties down" the regenerative set and avoids body-capacity effects. The coupling to the regenerative tube is readily adjusted by varying the number of turns on the coupling coil. The coupling should be fairly tight, but not so tight as to prevent the regenerative tube from going into oscillation.

In operation both super and regenerator should be tuned just as they would if both were independent and were being used to pick up the same signal. With regeneration at minimum the regenerative tube will have practically no effect on the signal; with the regenerative circuit tuned to the signal frequency and adjusted just below the point of oscillation, however, there is a very marked increase in signal strength, depending upon the initial pick-up. If a short antenna is used, the increase may be as much as four or five R's, being particularly noticeable on 'phone signals. Careful observation indicates that the increase in signal strength is accompanied by an increase in the signal-noise ratio, the difference being perhaps one point on the R scale as judged aurally. That is, if the original signal was R4 and the background R2, adding regeneration might increase the signal to R8 and the background to R5. At any rate, it has been possible to bring up signals to readability from being just audible in the background without regeneration. Maximum gain is of course secured when the regenerator is worked just below the oscillating point; however,

a definite gain results with the regeneration backed off far enough so that the tuning is not critical.

This method of introducing regeneration also provides a means for reducing image response in supers without pre-selection. Actually the image signal is left unaffected by the regeneration, but the increase in desired signal strength gives a decided improvement in the desired-signal to image ratio. Again talking in ham language, let us suppose that without regeneration the background is R3, the desired signal R5 and an interfering image R6. With regeneration at the critical point, the signal will be increased to perhaps R8, the background to R5, and the image will be unaffected. However, if the superhet gain control is reduced to bring the background back to R3, the desired signal will drop to R6 and the image to R4, approximately. In other words, the image is now considerably weaker than the desired signal instead of stronger as it was without regeneration, for the same background noise

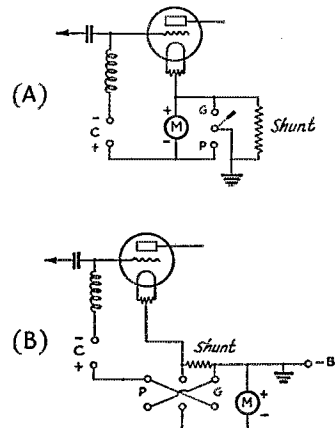

FIG. 3—SWITCHING THE MILLIAMMETER FROM PLATE TO GRID

level in both cases. The figures are of course only approximate. In practice it has been possible to pull up an amateur signal from being unreadable below an interfering image to the point where it was perfectly readable with the image practically inaudible. This was done using a small antenna; the improvement may not be quite so marked with a larger receiving antenna.

The "catch" is of course that for maximum results the tuning of the regenerative circuit is just as critical as though the tube were being used as a detector. However, for general listening the regeneration can be backed off so that the superhet operates normally; when additional gain or selectivity is needed the regenerator can be brought into play. Since no constructional work is required it may be well worth a trial by those having ham supers without pre-selection.

Milliammeter Switching for Grid and Plate Currents

Although many amateurs use plugs and jacks for transferring a meter from one circuit to another, it is often more convenient to use a switch for the purpose when the meter is to do only two jobs, such as reading grid and plate currents in a single stage. Bob Hayward, W9HDI, suggests the arrangement shown at Fig. 3A, making use of a single-pole double-throw switch to shift a milliammeter from grid to plate. With the switch thrown to the upper position the meter reads grid current; on the lower position a shunt is connected in to extend the meter range and the meter reads plate and grid currents combined. The shunt idea permits using a low-range meter of a value suitable for grid-current readings.

The circuit of Fig. 3B, used by Robert E. Foltz, W9GBT, makes possible separate readings of plate and grid currents, requiring, however, the use of a double-pole double-throw switch. With the switch thrown to the left, the milliammeter is connected to read plate current alone, a shunt also being connected in to extend the meter range. With the switch thrown to the right, grid current is measured. W9GBT uses a d.p.d.t. toggle switch for the purpose.

In both diagrams the shunt may be omitted if the milliammeter range is sufficient to take care of the plate current taken by the tube or tubes.

Improved Keying-Tube Circuit

The circuit of Fig. 4, utilizing keying tubes with a fixed-bias supply for blocking, is suggested by J. O. Sales, W6HFF. He writes:

"An examination of the circuit will show that the internal resistance of the keying tube is in

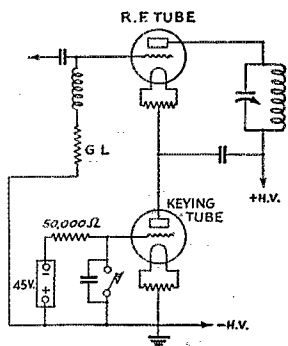

FIG. 4—TUBE KEYING CIRCUIT

Values are for a Type 45 tube, to handle an r.f. tube comparable to the 10.

series with the center-tap return. This resistance is high with the key open, thereby giving very high bias and low-effective plate voltage on the tube being keyed. The bias on the keying tube need not be as great as in usual tube keying systems; the effective bias on the two tubes in

series in the high voltage circuit blocks the plate current. The operation of the system is more positive than either grid-block or tube keying alone, and the current broken by the key is less. A slightly lower value of grid bias or leak than usual should be used because the plate resistance of the keying tube at zero bias is in series with the c.t. return (cathode bias) with the key down. This system works excellently with the crystal oscillator and allows break-in operation without any click in your own receiver."

More on Switchless Monitoring

The monitoring scheme outlined in the October Experimenters' Section by W3EHE has the hearty endorsement of Roy A. Jenkins, W6RB, who worked out the same type of system independently for use with the regular non-regenerative type of superhet. W6RB makes no provision for introducing the transmitter signal into the receiver, depending upon stray pickup for the purpose. He writes:

"The method allows break-in, provides a constant check on actual signal transmission, requires no relays, no extra phones are needed, nor is any switching whatever used. The fact that the monitoring signal is the same strength regardless of the receiver setting is in itself enough to make this scheme desirable.

"To put it into operation, the receiver, transmitter and frequency meter are all allowed to warm up a bit. If the oscillator is not keyed, rotate the freqmeter dial until the beat against the transmitter is heard in the receiver. Turn the receiver dial just a bit and see if the beat disappears. If it does, turn the freqmeter dial until another beat, one which does not disappear when the receiver is tuned, is heard. The beat is then on the intermediate frequency of the receiver and must necessarily remain unchanged when the receiver is tuned. When the oscillator is keyed, the key must be closed but the succeeding stages need not be operating unless a louder signal is desired. It should not take longer than five minutes to make the whole test; after that changes can be made to secure proper signal strength in the receiver.

"One point worth mentioning is that the receiver is equipped with a crystal filter, only the two transformers of which are shielded. Since the phasing condenser, shorting switch, crystal holder and socket are all unshielded there may be more signal picked up in this receiver than in one with the intermediate stages fully shielded. It may be necessary in some cases to leave the shield cap off the first i.f. tube, couple a short wire to the grid leak and stick it out through the cabinet, or even couple the grid of the tube fairly tightly to the output of the freqmeter. Individual station equipment will require different adjustments.

(Continued on page 100)



Amateur Radio STATIONS

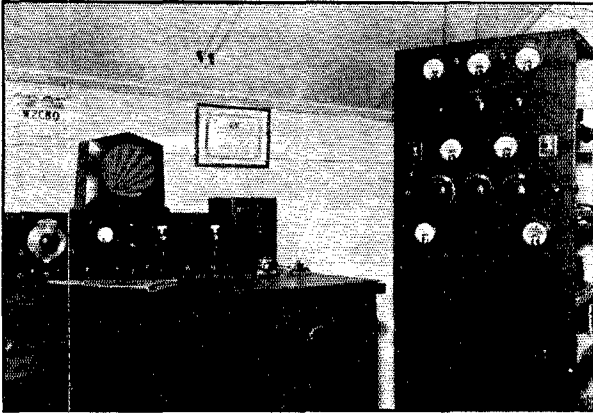

W2CBO, Scotia, N. Y.

R. A. LASH of 111 Pershing Drive, Scotia, N. Y., is the man behind the key at W2CBO. His first license, under the call W8CQS, was issued in 1928; moving to New York in 1930 brought W2CBO.

The transmitter shown in the photograph consists of 47 crystal oscillator, two frequency doublers using 46's, a pair of 10's in a buffer amplifier and push-pull 211's in the final. Power is furnished by four separate rectifier-filters and the input to the final amplifier usually runs about 500 watts with a plate voltage of 1400. Plate and grid meters are provided for all stages.

The receiver is a duplicate of the original crystal-filter single-signal receiver described in *QST* in 1932. To its left is a frequency meter-monitor. A 3.5-mc. Zepp antenna, 40 feet high, is operated at all frequencies.

While W2CBO has operated both 'phone and c.w. in the past, present operation is confined to c.w. in the 3.5, 7, and 14 mc. bands. WAC was made during the last DX contest.

W7BVL, Seattle, Wash.

THE accompanying photograph is a general view of W7BVL, owned by Howard L. Dull, 7214 Talatine Ave., Seattle, Wash. In the design of the station, good quality transmission rather than power output has

been the first consideration. Most of the operating is done on the 20- and 75-meter 'phone bands, with a power input of 150 watts. W7BVL has been on the air since January 1932.

The rack and panel on the right contains a four stage r.f. unit, consisting of a 59 crystal oscillator, a 59 buffer-doubler which excites two type 10's in push-pull, and a link-coupled 211 as a final amplifier. Grid leak bias is used in the final amplifier, and the coils of the r.f. exciting units are shielded to eliminate feedback. The high-voltage and low-voltage power supplies are at the bottom of the rack; next above are the low-power stages, followed by the final stage and antenna matching network. The antenna used at the present time is a 75-meter center-fed Hertz with 45-foot feeders and 120-foot flat-top.

The audio equipment includes an Amperite velocity microphone with a four-stage resistance coupled pre-amplifier employing a 75 high-gain triode, a 76, and two 37's. The pre-amplifier is not

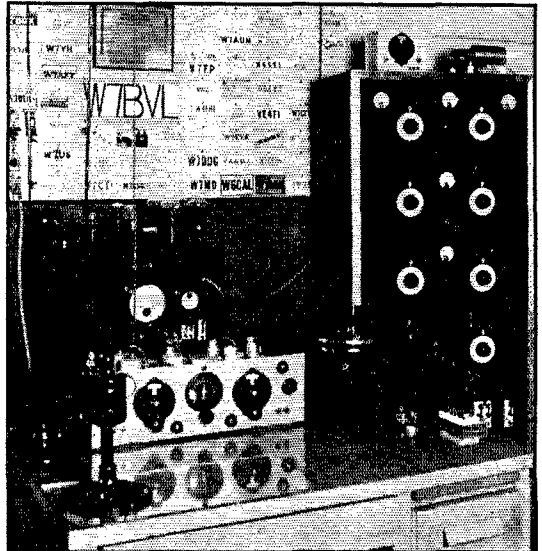

W7BVL

shown in the picture, but it is one completely shielded unit. The output of the pre-amplifier feeds into two 56's in push-pull, followed by two 2A3's as push-pull drivers. These in turn excite four Type 50's in push-pull parallel as Class-AB modulators, making a total of seven stages of audio. The modulator and high-level audio equipment are in the rack on the left—the large meter shown in the picture is in the plate circuit of the modulator, and provides a check on modulation. The additional equipment includes a vacuum-tube voltmeter and a special two-stage amplifier in the phonograph box on the desk. It is utilized for the phonograph pickup, and as an emergency pre-amplifier for a carbon mike.

The receiver at W7BVL is a nine-tube home made superheterodyne which incorporates a.v.c. and an "R" meter. A separate matched impedance doublet receiving antenna is used making possible duplex operation. Cuba, Mexico and the Hawaiian Islands, as well as all districts in the United States and Canada, have been worked on 'phone, and SWL verifications have been received from beyond these limits.

W6GHD, Walnut Creek, Calif.

GEORGE S. BENNETT of Walnut Creek, Calif., owner of W6GHD, first ventured into amateur radio in 1909. Seven or eight years of sea-going brasspounding followed—must have seemed enough to last a lifetime, since he swore he wouldn't touch a key again! However, the bug wouldn't be downed, and 1932 found him back in the game with more enthusiasm than ever.

W6GHD has two transmitters, the large rack-mounted one at the left in the photograph being a c.w. rig capable of inputs up to a kilowatt. It uses a 47 crystal oscillator, push-push 45's as doublers, a 50-T driver and a pair of 150-T's in the final. An auto-transformer with plenty of taps makes it possible to vary the plate voltage to the final in steps of 500 volts. For trans-Pacific work, a specialty of this station, the input usually is about 600 watts.

The small rig on the file cabinet at the right in the photo is a low-power 160-meter 'phone job using a pair of 46's to modulate a pair of 45's in the final. The r.f. plate input is about 40 watts. The receiver will be recognized as a Hammarlund Comet Pro.

W6GHD's chief interest is handling traffic over the Pacific. Schedules were maintained with AC2RT and KA1NA for about two years before these stations closed down. At the present time



W6GHD

schedules are kept three times a week with both OM1TB and VK6MO, considerable Carnegie traffic being handled with the latter. W6GHD is WAC and also an ORS.

Silent Keys

It is with deep regret that we record the passing of these amateurs:

- Harry D. Blain, W6BLS, Monrovia, Calif.
- Dorothy Dodds, W9OSJ, Mindenmines, Mo.
- S. L. Easley, Jr., W5AMF, Hereford, Texas.
- Eggar R. Gamble, W4CTK, Kings Mountain, N. C.
- Alfred H. Grebe, ex-W2ZG, Richmond Hill, L. I.
- Robert L. Green, W8GGH, Cleveland Heights, Ohio.
- William E. McMurtry, W5AHC, Longview, Texas.
- George P. Taylor, W9BAN, Henderson, Ky.

Strays

Old Poor Richard may have been one of the original amateurs, but he's been a long time getting a call. W9OKZ writes that W8ONJ has just been issued to Benjamin Franklin!

Why buy a receiver when an electric stove will do just as well? W5AID says his 75-meter fone rig puts a QSA4 R5 signal into a teakettle on the electric stove in the kitchen of one of his neighbors!

With the Affiliated Clubs

Hamfest at Indianapolis

DECEMBER 7th and 8th are the dates set by the Indianapolis Radio Club for its big ham-fest. Activities will center in the Indianapolis Power and Light Auditorium, 1234 West Morris St., Indianapolis, Ind., and will take place from 10:00 a.m. Saturday (the 7th) until Sunday p.m. Admission is fifty cents. The program will include some of the finest talks and demonstrations ever presented at any ham gathering on subjects of interest to all. A special committee has arranged to provide answers to any ham problems which may be troubling you. Come early and avoid the rush!!

Houston Amateur Radio Club

The Houston (Texas) Amateur Radio Club is working out plans for better coöperation with the Red Cross in times of emergency. Definite and systematized arrangements will make possible fullest amateur radio aid in time of need. The H.A.R.C. is building portable equipment for emergency use.

Intercity Radio Club

The Intercity Radio Club, which includes the amateurs of Mansfield, Shelby, Galion, Bucyrus, Crestline, Tiro and Mt. Vernon in the state of Ohio, presented a c.w. and 'phone station on the air at the Richland County Fair, Mansfield, September 17th-20th. Operation was under the calls W81WK and W8WE. This was the first public display of amateur radio in that vicinity and attracted much public interest. Many contacts were made and some traffic originated and handled via schedules with W8JJM, W8BCA and W8DQA. Operators were W81WK, W8NAE and W8WE. The highlight of the exhibit was a chess game between W8WE at the Fair Grounds and W8JJM in Mansfield.

At the Shelby Community Street Fair, September 26th-28th, the I.R.C. was given the use of a business room, light and water, and another exhibit was put on, which was well attended by local citizens. An amateur station operated under the call W8EMK. Operators were W8EMK, W8DWP, W8FQY and W8PO. Traffic outlet was provided via W8KUY. The regular club meeting was held at the exhibit room on the 27th. The Intercity Radio Club plans to repeat these exhibits, the publicity from which is beneficial to amateur radio.

Navy Night

The Oakland Radio Club is indebted to Fred Mangelsdorf, W6KTU, who secured speakers and

sound-pictures from the Naval Reserve unit in Oakland, Calif., for the September 17th club meeting. Speakers were Lt. Commander H. U. Linkins, commandant of the 12th Naval District, U.S.N.R., Lt. (jg) Lucas, and Chief Radioman U. Stenbach.

CRM Stenbach, U.S.N.R. opened the meeting with a terse history of Naval radio equipment from the days when the admirals and captains flatly refused to have radio equipment aboard their ships because it spoiled the symmetry and gracefulness of the Naval vessels by adding unsightly aerials, to the present day when radio is one of the most important features of our "first line of defense." He told of the difficulties encountered during the last war when operators were at a premium, unskilled, not knowing Naval procedure, unfamiliar with the various codes, of their difficulties with the old spark and arc sets in use in the "good old days," of the intensive course in radio given to new men, a six months' course with one month at Harvard before being shipped to sea as full-fledged Naval radio operators. It was a good talk and well received.

The second speaker, Lt. Comdr. Linkins, U.S.N.R., told of the present organization of the Naval Reserve, its aims and ambitions, the two weeks' cruise every year available to members, their drilling, seamanship instruction, and other phases of Navy life. He made one very pertinent statement: During the World War it was figured that it took at least six months to train a radio operator in radio fundamentals, then another thirty days of the most intensive instruction before an operator was sent to sea; seven months in all. It is now estimated that thirty days' training will enable the present members of the U.S.N.R. to go over the side of a Naval vessel, knowing procedure, tactics and thoroughly familiar with shipboard life!

Lt. Lucas, U.S.N.R., added to the comments of CRM Stenbach and Comdr. Linkins by telling more about the present set-up of the Naval Reserve Communication System, always stressing the point of accuracy and speed, so essential to the fleet maneuvers in all its many ramifications, from the huge "battle-wagons" down to the little "Eagle-boats" and lowly colliers and tugs. Six reels of sound pictures were shown. Subjects covered were "General Navy Battle Maneuvers," the light draft Naval vessels on "Yangtze Patrol," "Submarine Service," "Sky Service" and ships in "Far Eastern Service." The old U.S.S. *Utah*, ex-NVE, has now been converted to a floating radio laboratory, capable of being controlled

(Continued on page 114)



CALLS HEARD



W7AVV, Vern C. Sahnov, 518 E. Edison St., Hillsboro, Oregon

(23-mc. band. Aug. 15th-Oct. 15th)
w1aw w1av w1ear w1df w1dze w1ias w1zb w2dza w2fdl w2gjb w2tp w3byf w3cpk w3dlb w3evt w3far w4agp w4ajy w4auu w4ces w4ef w4hc w4mr w5acf w5aki w5afv w5afx w5bdt w5bkl w5axi w5cqp w5dww w5dnn w5dsw w5ehm w5wg w5af w5eub w5ql w6avt w6awt w6cwx w6dio w6ewe w6iju w6rh w6wq w6idf w7amx w7aem w7bd w7bpj w7bqd w7cei w7dhf w7fh w8agu w8bof w8cra w8cte w8cxf w8cxo w8dhe w8dpo w8dwj w8dyk w8enf w8fda w8fjj w8hfe w8hgw w8itk w8irm w8ixa w8jbp w8jin w8lrc w8mwy w8car w8aag w9abe w9agx w9ace w9bqm w9brv w9ces w9dhn w9drn w9dos w9fj w9fm w9gjb w9gdh w9ghc w9haq w9hja w9jgs w9drd w9mw w9ndb w9nro w9nrd w9dos w9oys w9lf w9st w9ffq w9tj w9sp w9spv w9uww w9wv w9iwe w9rao w9ny x1ay k5ag k6aja k6ewq j3fj j2hj lulep lu2am lu9bv py2qd alba ss1h vk2lz vk2hs vk2hf vk3bd vk3yp vk4xn vk4bb vk4ei

W9NY, H. F. Wareing, 4547 N. 21st St., Milwaukee, Wis.

(28-mc. band. Oct. 1st-Nov. 1st)
cm2do cm2dq cm2wd co6om cplac cx1eg d4arr d4gwf d4kpf f8ct f8ox f8vs f8wk fa8cr fa8ih g2hg g2mw g2nh g2pl g2yl g5by g5la g6dh g6lh g6nf g6wy k5ac lulep lu3dd lu3dh lu3dx lu7ax lu9bv oa4j oklaw on4ac on4au on4ij pagax pasqg py2qd sulag velep ve5hr ve5pt vk2hs vk2lz vk3bb vk3bd vk3bq vk3kk vk3kx vk3yp vk4ap vk4bb vk4ei vk4gk voli w1av w1emx w1gsh w2bcr w2dza w2tp w3air w4agp w4ais w4ajy w4bbr w4bvd w4cbv w4cqr w4cuj w4cyu w4mr w5afv w5afx w5ql w5wg w6aaa w6aef w6agi w6bnu w6bzl w6bxv w6byu w6cal w6cam w6cis w6cuh w6cwx w6dc w6dov w6dgp w6dhw w6dio w6dij w6dlm w6dmn w6dob w6dqd w6eps w6ewe w6fkq w6fp w6gal w6grx w6gtd w6gtm w6hdy w6hgw w6hko w6ivu w6iuj w6iju w6jkh w6jn w6jnr w6kbb w6kby w6kdb w6kgd w6kip w6kpr w6kbr w6kri w6ldf w6ldj w6ldg w6lrv w6ln w6ltp w6lyx w6lyc w6qd w6rh w6sc w6vq w7ahk w7amx w7avv w7bd w7bkl w7cat w7cei w7cht w7dl w7dmn w7dwl w7ejk w7evv w7ip w8era w8cte w8fad w9bqm w9bse w9drd w9drn w9fm w9haq w9ij w9lf w9st w9th x1aa x1am x1ay x1cz x2c x2l x2n z1gx z1zq z1zh zu9p

R. D. Everard, Westgate House, Great Gransden Sandy, Beds., England

(3.5-mc. 'phones)
ve1dt ve1er w2nw w2fak w2au splcm h17g co8yb w3glc
(14-mc. 'phones)
cx2ak vp2cd lu4bl lu6ap py2ba py2gj celbe vp2km voli k4ddh ti2av h17g hi6o hpl1a k4sa py2bd la1g w5za w9gyk w9kfa w9ldj w9bpb w9bbu w9axm w9bho w9ap w9ark w9dcp w9nno w9bg w9bmb w9gic w9fj w9ji w9gao

F8BL, Ecole Polytechnique, Paris, France

(14-mc band)
w5uq w6hx w6epp w6fzy w6ph w6hjr w6co w7bbx w5kbb w5sav om2rx

W6KRI, Dale Schuyler, Box 218, Whittier, Calif.

(14-mc. band)
g2bm g2ds g2kx g2nm g2pl g5bd g5bs g5by g5qa g5le g5ml g5vb g5yh g6bb g6bs g6cj g6dl g6kw g6kl g6nj g6uf g6wy g6yu f3le f3eb f3em f3eo f3er f3fe f3fs f3fp f3tg f3vb f3wb e1sf e1sb e1sg ea4ak ea4ao ea4av ea4ep pagce pagjm

pa8ll pa8ms pa8qq pa8wh pa8xf pa8zk pa8zm on4ac on4cc on4ce on4id on4rx on4uf on4uu on4vw on4au ok1bc ok1ro ok2ak ok2ms oeler oelfp oe3fl oe3wb oe7ej oe7jh oh3np oh7nc d4bar d4bbn d4bjh d4caf d4cda d4fnd d4gad d4ksj d4ksw d4lwn d4ltn d4mnl ly1j ly1zb la1ca la2x hb9j hb9w splar splbq splco sm5tm sm6uj sm7yg sm7yn y12bb i1ww oz7s oz7zl g6yw t1fg xzn2b su1aq su17af st6ak zelis vq4crp on4csl u1bl u2ne u3ag u3cy u3dh u3qe fb8c fm8gl f7cgv zt6y

(7-mc. band)

f8ex ct2bk on4au on4fe d4bar zslb zslh zszf szsn szsx zsz4 zsz5 zsz6 zsgm zsfaf zsfal zsfam zt2l zt2c zt5r zt5v zt6j zt6n zt6ak zule zulp zult zu5e zu5ac zu6l zu8p cr7ad cr7aw zeljr k3zr xzn2a xzn2b cr8aa

W6GAL, George Sinclair, 809 Pine Ave., Compton, Calif.

(7-mc. c.w.)

ct1ed cn8fr d4cda ea3eg ea4ao ea4av f8ex hb9ak ss1oc st2d u2ms

(7-mc. 'phones)

hc1fg j2hs lu1ha lu4bc lu5cz py2ak vk2wn vk4uu vs8ab vs8ae rv2am

(14-mc. c.w.)

ag6zra d4arr d4bgk d4bnj d4bfn d4caf d4cda d4eim d4ljm d4lev d4ltn d4mnl d4pn ea4ao e1sf e18f ei8b ei8g f8ej f8eo f8ex f8eb f8fc f8hg f8ke f8pz f8ta f8vj f8vp f8wb g2ak g2bk g2bm g2by g2db g2dh g2di g2dv g2hx g2ic g2ki g2kv g2mu g2nh g2nm g2oi g2pl g2sx g5bd g5bj g5by g5cw g5cy g5df g5ds g5fa g5gc g5gs g5ja g5kf g5kg g5la g5ml g5qa g5qy g5ar g5ay g5ux g5vb g5vl g5vm g5xg g5yg g6bb g6bs g6cj g6dh g6dl g6ir g6jb g6ku g6lk g6nj g6ox g6oy g6qs g6qv g6qx g6rb g6rv g6uf g6us g6vp g6wn g6wy g6zx g6yu g6yv g6as g6xu g6zx g6yx g6ix g6iav hb9ak hb9aq hb9j hb9y la1g ly1ag ly1j ly1zb oeler oelhf oe3fl oe3kh oe7ej oe7fh oe7jh oh3np oh6a oh7nc ok1bc ok1ro ok2ak ok2bx ok2dd ok2kp ok2ms ok2op ok2rm on4ac on4au on4fe on4hm on4mx on4pa on4rx on4sc on4sd on4uu on4za oz2m oz7s oz9wb pa0ax pa0ce pa0dc pa0ff pa0fp pa0jmw pa0kg pa0ll pa0np pa0pn pa0ql pa0qq pa0rn pa0rv pa0sd pa0un pa0uv pa0xd pa0xf pa0yq pa0zk pa0am pa0az sm5ax sm6ua sm6uj sm7yn spldc ulap u1bl uler u2de u2ne u3ag u3cy u3dq u3da u3qe u4ld u6ah y12bb cr7gc fb8c su1aq su1ec su1sg vq8a zelje zeljn zeljs zalal zszj zszm zsfaf zsfam zsb6 zst6 zt1q zt5v zt6ak zt6y zu5y r1v xerh xzn2c zu8p

(14-mc. 'phone)

celbe co2hy co2ww co2xf co2wz co6in co8yb cx2ak hc1fg hi7g hh5pa hpl1a k4sa ka1ak k6bar k6cm hc1ff k6kef lulen lu3fc lu5cz lu6ap lu7ax lu8dr lu8jr lu8jb oa4b on4ac py2ak py2ba py2bu sm5ax t1zay vk2ep vk2bq vk2qn vk3kx vk4bb vk4zl u2ne t1zav t1zcr t1z3wd

OK1AW, Alois Weirauch, Mestec Kralové, Czechoslovakia

(28-mc. band. Oct. 5th-14th)

ea3cy fa8ih zslh zt6k zule w1sz lulep w4agp

ON4AU, J. Mahieu, Le Manoir, Peruwelz, Belgium

(14-mc. band. Sept. 1st-30th)

celan celje cel2i cm2do cm2fa cm2rs cm2zf cm2ww cm5my cm8mf ep1ac er8aa ex1cb ex1ce ex1ej cx2ak cx2ia cx3bl ea8af f3mtd fa8cr fa8gt fa8h fb8c fm4af hc1fg hh5pa hj3aj hpl1a j2kj j2lb j3cr j3dp j5ce j5co j8ca j8ct k4bu k4brn k4ddh k4rj k5aa k5ac k5af k5am k5ar kалан kалem kallb on4csl pf2db px1b px1bg pylaw py1dj pylif py2ae py2ak

py2ap py2ax py2bh py2ce py2dy py2dq py2qd py5aa py5af
 py5an py5ay py5bz py5de py5dl py5ds py5du lu4dq lu5bd
 lu6db lu6djk lu6jb lu6uo lu8en lu9af sulch suilk sulro
 sulas sultm sulwm su2tw su5nk su8ia tf3c tf5c u9ml ve4fv
 ve4gc ve4gl ve4is ve4ro ve4sv ve4uq ve5bg ve5gi vk2as
 vk2ax vk2bk vk2bw bk2bx vk2el vk2eo vk2er vk2ex vk2fy
 vk2hd vk2hq vk2hp vk2hs vk2io vk2oe vk2ov vk2sq vk2tf
 vk2th vk2vq vk2ac vk2ah vk2zr vk2zw vk2xm vk2xu
 vk3cn vk3co vk3cp vk3cx vk3cg vk3kg vk3ki vk3kr vk3n
 vk3jr vk3rx vk3ox vk3pg vk3qe vk3qx vk3vp vk3xw vk4bb
 vk4do vk4ei vk4er vk4eg vk4ka vk4le vk4pg vk4sf vk5je
 vk5fm vk5hw vk5kl vk5ks vk5le vk5lv vk5nr vk5rt vk5su
 vk5wj vk5wk vk5wr vk6fl vk7jb vk7ck vk7er vpljr vp2bx
 vp5ps vp9o vq3mn vq4cro vq4crq vq4kta vs1aj vs2ag
 vs6aq vs6ax vs6bd vu2by vu2dk vu2ep vu2jp xlam xlav
 x2e x2n xu2jm yslfm zblil zblh z2ce z8a zeljb zelje zeljn
 zeifm zeijs zli2c zli2gn zli3d zli3a zli4q zli4t zsal zslb
 zslh zs2z zs4i zs4u zs5j zs5z zs6t ztlr zt5p zt5v zt6ac zt6ak
 zt6al zt6b zt6e zt6m zt6w zt6z zu6b zu6p zu9b w4ajy
 w4auu w4ayp w4azb w4ech w4dml w4bfn w4dbk w4cre
 w4ef w4ft w4kml w4pey w4tj w4tr w4ru w4yce w4yep
 w4yrc w5bf w5bg w5by w5cu w5cz w5duq w5ega w5ehm
 w5hx w5lr w5no w5qj w5sq w5sf w5sat w5wcb w5byu
 w6ouh w6cxw w6ddf w6exq w6grl w6grx w6inp w6jnr
 w6kip w6llf w6lyu w6qj w7amz w7bme w7bzb w7dsz
 w7euy w7fbn w7fq w9adn w9ajy w9abu w9ace w9aqw
 w9dbc w9dij w9dje w9dxx w9ddq w9evx w9gbs w9cra
 w9hag w9het w9hpw w9ka w9lhi w9lvj w9nro w9nsc w9pov
 w9rbi w9rnu w9rso w9rto w9she w9sie w9syi w9sey w9tj
 w9tul w9urs w9uzb w9vdy

(28-mc. band)

lulep lu3dd lu3dh zslh sulc st6k

W7BME, Frank Lundburg, 188-3d St., Idaho Falls, Idaho

(14-mc. band. Sept. 29th-Oct. 5th)

cx2ak d4gad g4gof d4lwn d4nrx ea3an ea4ao eif5 eif8 f3jc
 f8dr f8eo f8fo f8jy f8fq g2ae g2de g2kc g2mr g2nn g2nd g2vy
 g2yy g5ga g5li g5qa g5ay g5bc g5ci g5ma g5nj g5rj g5wy
 g6qx g6fs hb9a hb9y i2en j2lb k3ar kalcm lu2fc lu3ds
 ce7jh oh3np ok1bc on4au on4ds on4my on4rx os7al pa0ax
 pa0ce pa0ms pa0rn pa0zk pk2bm py2qd sm5sz sm6ua fi5al
 u3ag uk2ex uk3ce vp5ae vp5ps

F8VJ, Lucien Becquet, Françières, par Estrées, St. Denis, Oise, France

(14-mc. c.w.)

w4ajy w5bec w5bmm w5ehm w6env w6tj w6cxw w6fal
 w6jpr w6gnz w6vb w6grx w6byu w6fzy w6egh w6euh
 w6bam w6adp w6qd w6fal w6awt w6rh w6ahs w6grl
 w6lhx w6cnd w6hjt w6dy w6cyv w6khv w6kvr w6bgy
 w6aad w6ies w6jcz w6he w6gal w6ixs w6bgj w7fh w7ejd
 w7bme w7aod w7bby w7bnk w7aij w7amx w7bub w7bpj
 w7axo w7eht w7amq w7qc w7dl w7cmo w7dxx w7vq w7aax
 w7wl w7avl w7kf

BRS 1338, Donald W. Morgan, 15 Grange Rd., Kenton, Middlesex, England

(14-mc. 'phones)

w4czg w4zf w4tj w4apq w4bya w4bfb w4cre w4ah w4aqu
 w4ec w4auu w4axz w4agr w4agp w4hx w4bsh w4um w4ahh
 w4ac w4dlh w4doh w4clh w4kh w4oe w4bqs w4wp w4bpr
 w4pw w4ws w4bcr w5eli w5zf w5bee w5aeb w5app w5ox
 w7fl w7wa w8htz w8ady w8cko w8aku w8cns w8gly w8cig
 w8ctn w8jod w8ci w8gqs w8luq w8jlu w8im w8fhe w8imf
 w8dl w8hfu w8epf w8za w8fsa w8ffa w8lx w8kl w8lpi
 w9hbt w9acu w9cay w9ark w9zx w9azs w9jj w9eel w9wa
 w9tpt w9awm w9dap w9bde w9ing w9bpk velea ve1er
 ve1fe ve2hm ve2ge ve2hk ve2ca ve2ee ve3he ve3kw

Thomas A. Cirno, 1012 Morris St., Utica, N. Y.

(14-mc. 'phones)

co2an co2ra co2sv co2ke co2hy co2ll co2sd co2om co2ws
 co2na co2wv co7hf co3yb eo4ae eo4gi eo5ml g6dl g6xr hpl1
 hh5pa lu5cx lu6ap lu9pa on4ac p5nc p5lk py2ba py2bd ti2av
 ti2pu ti2fg vp3bg vp5pa vp6cs vp6yb vp9r voli x1w x1q
 x1v x2ah

J2LU, H. Shimomura, 55 Wada, Hommoku, Nakaku, Yokohama, Japan

(7- and 14-mc. bands. April-Sept. 1st.)

wlgyd wlhdh wlbug wlcmx wlias wldnl wlavv wlgdp
 wlbcx wliqz wlud wloca wita wlarb wldya wlhtp wlgf
 wlduj wlhuo wloun wlfoa w2eie w2gw w2shr w2fhi w2gah
 w2cto w2bhw w2dtv w2czv w2gox w2eko w2oa w2dhs
 w2fhi w2arb w2evi w2kzv w3fbf w3amp w3aw w3aga
 w3bzb w4dhs w4cby w4bbp w4bbr w4sv w4ef w4cen w4aiy
 w4ej w4cyq w5cuj w5dxg w5auc w5ql w5ega w5bxm w5ddp
 w5ehm w5bno w5aot w8fbc w8zy w8fv w8cy w8ajm
 w8llj w8dgp w8dvr w8era w8edw w8dva w8cxz w8adg
 w8cns w8jin w8bti w8euy w8djj w8jy w8vdx w8vax w8vbd w8vee
 w8yay x1aa x1am x1ay x1da x2c x2n g6vf g6gd g6rb g6vg
 g6nj g6py g6xq g6bq g5dl g5bd g5ay g5gq g5qa g5qy g5wp
 g2ic g2dv g2tm g2bk g6yvw g2by f8lr f8ro f8um f8za f8ri
 f8ef f8eo f8fr f8eb f8fc f8cgv f3je d4lyn d4cda d4aii d4cef
 d4app d4bbk d4kmg d4bar d4caf pa0ay pa0ce pa0dc pa0ql
 pa0rn pa0zk pa0un pa0ll pa0sd pa0yl pa0ff pa0jmw oh5nr
 oh5nf oh3np oh3nf oh3na oh3oj oh3d oh7nf oh3nf oh3nb
 on4ac on4au on4lx on4vw on4hm on4ej ok1fa ok1fd ok2h
 ok2ms ok2mm ok2op oeler oe7jh oz9wb u3dq u3hr
 u3ag u3qe u3cy u3qt u3di u3vb uap ucr ulbl u2ne es1o
 es2d es7c ea3eg ly1zb ly1j la3e y12bb yu2af uk3ca hb9a
 ct1ah sm5ys sm6ua sm6vy sp1dc sp2bc sp1dc sulch s6a
 z6af z6af z6b z6m z6c z6h z6t z6x z6p z6q z6k z6w
 z6m zt2b zt1q zt1h zt5v zu6b ze7jr ze6lf zblht vq4cro
 vq4cl ft4af fb8c lu5fv lu4be lu2eg lulad lu4dc lu7ch lu2am
 lu3dx lu5ua lufer lu6jb lu5bl lu9bv cx7cg cx7bu cx2ak
 vp5ps em2ww vr4ba ti2zr

F8BL, Audebrand, 9 Rue Dulac, Paris 5, France*

J2HJ, Kunio Shiba, 12 Akebonocho Hongo, Tokyo

(Heard during July on 14 mc.)

cx1bg d4ibu d4ca ea3eg f7cg f8lu f8ru f8ug fb8c g6nj g6vp
 haf6h ha7fg i1tkm lu2am ly1j ly1zb oeler oe1jh oe7je ok2op
 ok2ms ok2rn on4au on4u u3di oz9wb pa0pn pa0sd ex3a
 sm7yn sulaq sulre u3am u3bi u3cy u3di u4h u6ad u6ah
 vq4cro vs1aj v23jp velfn ve4fi ve4hw wldld w1lc w2af
 w2dew w2evi w2cup w3czo w3eqn w4bbp w4bbr w4bwe
 w4bwn w4cfj w4cby w4dhs w4ft w4tr w4ux w5agq w5bvf
 w5ddq w5eip w5egf w5bfg w8ca w8dxn w8dyv w8fzx
 w8gyb w8jw w8jtw w8lef w8mqq w9aeh w9arl w9aap
 w9dho w9btw w9ela w9fwn w9gfg w9gkz w9lpp w9iu w9jh
 w9jfb w9jie w9lhb w9min w9nup w9pri w9ptf w9rbb w9rgh
 w9spb zeljr zblh x1u

W2DJY, Vic Borton, on board S.S. West Isleta, Between Hong Kong and Vladivostok

(14-mc. c.w.)

w2bxa w2bhw w2gox w5am w5aqt w5baf w5bdf w8fsk
 w8faj w9fj w9bvp

(14-mc. 'phones)

Charles C. Larcom, Signal Corps, U. S. Army, Fort Hughes, P. I.

(14-mc. 'phones)

w4abi w5av w5vs w6avs w6bay w6bky w6byw w6cne
 w6cqs w6crh w6edv w7bcl w8wa w9ar

(14-mc. c.w.)

ve5bi w5ld w6cea w6cgp w6cxw w6cay w6dri w6dth w6dvi
 w6dyh w6env w6fay w6fms w6ghg w6gpb w6hx w6hex
 w6inp w6jnl w6lvy w6lpx w6lhw w6ldj w6os w6qa w6vb
 w7amx w7avi w7bd w7bme w7ns

W1AJZ, Rienzi B. Parker, Harwichport, Mass.

(14-mc. 'phones. June 15th-Sept. 15th)

celbc co2by co2ll co2av co2ws co8om co8yb f8dr g2bv g5bj
 g5ml g5ni g5vl g5yy g6dh g6dl g6fs g6x hh2w hi6o hi7g
 hp1a k6ddn lu6ap lu8ab lu8dr on4ac py2ak py2bd ti2re
 ti3av ve4bf ve4la ve5am ve5hn ve5jk vp6cs vp9r x1g x1w

• I. A. R. U. NEWS •

Devoted to the interests and activities of the

INTERNATIONAL AMATEUR RADIO UNION

President: H. P. MAXIM

Vice-President: C. H. STEWART

Secretary: K. B. WARNER

Headquarters Society: THE AMERICAN RADIO RELAY LEAGUE, West Hartford, Conn.

MEMBER SOCIETIES

American Radio Relay League
Associazione Radiotecnica Italiana
Canadian Section, A. R. R. U.
Ceskoslovenski Amatéri Vysilaci
Deutscher Amateur Sende-und-Empfangs
Dienst
Experimenterende Danske Radioamatorer
Irish Radio Transmitters Society
日本アマチュア無線聯盟
Liga Colombiana de Radio Aficionados

Liga Mexicana de Radio Experimentadores
Nederlandsche Vereeniging voor Internationaal Radioamateurisme
Nederlandsch-Indische Vereeniging voor Internationaal Radioamateurisme
New Zealand Association of Radio Transmitters
Norsk Radio Relé Liga
Polski Związek Krotkofalowcow
Radio Society of Great Britain

Rede dos Emissores Portugueses
Reseau Belge
Reseaudes Emetteurs Français
South African Radio Relay League
Suomen Radioamatööriliitto r.y.
Sveriges Sändareamatörer
Unión de Radioemisores Españoles
Union Schweiz Kurzwellen Amateure
Wireless Institute of Australia

Conducted by Clinton B. DeSoto

DX Score:

W4EG's DX scoring system, proposed on page 41 of the October issue of *QST*, has aroused appreciable comment, both pro and con. The general consensus of opinion seems to be that it is a good system, but that it has its faults — these being primarily matters of definition, like all the rest of these DX problems. In view of the generally favorable reception of the suggestion, we are pursuing the matter to the additional extent of umpiring a few of the questions that have been raised and suggesting some uniform solutions.

The principal objection to the system, which, it will be remembered, comprises the counting of *districts* worked, as indicated by prefix sub-divisions, seems to be that not all numerals following prefixes indicate geographical divisions. Countries where this is true are: Algeria (FA), Argentina (LU), Bolivia (CP), Dominican Republic (HI), Egypt (SU), Great Britain (G), Guatemala (TG), Hungary (HAF), Iraq (YI), Irish Free State (EI), Norway (LA), Panama (HP), Paraguay (ZP), Poland (SP), Uruguay (CX), and Venezuela (YV). Under the present call assignment systems in these countries, only one point can be claimed for each country in the DX Score. Information concerning other countries where these conditions apply is requested.

A number of other, less obvious, points have been brought up. Among these is the status of such calls as W10, VE6, VE9, etc. Since the DX Score is based on geographical coverage, these prefixes fall into the same category as above, and do not count. Ships at sea, it would seem, cannot logically be counted, considerable discussion of this point having evolved no reasonable ruling. In South Africa, the prefixes ZS, ZT and ZU are

regarded as identical, only the numerals being counted, giving a total of six districts. NY1 and NY2, being irregular amateur prefixes, it seems can best be combined with K5 to give one point to the Canal Zone.

We wish again to emphasize that the DX Score system is offered only as a suggestion, in the interests of uniformity. Its use or non-use, adaptation or modification, is strictly up to the individual. But it does offer an interesting and sporting new DX goal to shoot at. Further comment is solicited.

Erratum:

Incorrect was the first digit in the membership figure given for the R.S.G.B. in the November issue. The thriving, active British Union member had a membership total of 2200, not 1200, as stated; the membership now, less than a year after the figures quoted were issued, is in excess of 2500.

QSL:

J. MacIntosh, ex-VS2AF, has resumed his post as R.S.G.B. representative for Malaya and Borneo, and all cards can be sent to him in care of the Posts and Telegraphs Dept., Penang, Straits Settlements, Malaya.

The correct address of the J.A.R.L. Japanese QSL Bureau, is as follows: P. O. Box 377, Tokyo, Japan.

Regulations:

The P.Z.K. reports that the following bands are open to amateur operation in Poland: 3.535-3.565, 7.05-7.245, 14.09-14.31, 28.16-29.83, and 56.3-59.68 mc. Operator and station licenses are

both issued upon examination, without fee, in cooperation with the P.Z.K. Both 'phone and code are permitted, the maximum input being 50 watts. The Polish government regards amateur radio as a cultural asset. There are 200 licensed stations in Poland; the P.Z.K. has 520 members.

From the Newfoundland Amateur Radio Association comes the information that no power limit has been fixed in Newfoundland, all Madrid bands are open but special permission is required for 1.7-mc. operation, c.w. and 'phone subdivisions are similar to those in the United States, an operator's license costs \$1.00, a code speed of 12 words per minute is required, a station license costs \$2.00, the station license covers operation of portable equipment under the station call with the addition of /P to indicate portable operation (the R.S.G.B. proposes that a similar system be followed throughout the world), third party traffic is permitted, and pure d.c. is required. On June 30, 1935, the end of the licensing year, there were 22 amateurs licensed, of which nine were members of the N.A.R.A.

The R.E.F. reports the following sub-division of French prefixes by the Posts and Telegraphs Ministry:

- CN8: Morocco
- F3, F8: France proper
- FA3, FA8: Algeria
- FB3: Madagascar
- FD8: Togo
- FE3: Cameroons
- FF8: French West Africa
- FG8: Guadeloupe
- FIS: French Indo-China
- FK8: New Caledonia
- FL8: French Somaliland
- FMS: Martinique
- FN8: French Indies
- FO8: Oceania
- FP8: Islands of St. Pierre and Miquelon
- FQ8: French Equatorial Africa
- FR8: Reunion Island
- FT4: Tunisia
- FU8: New Hebrides
- FY8: Guyane

Amateur station licenses are readily obtainable in Estonia. The operator is required to pass an examination on code practice and radio fundamentals in order to secure his license. The annual fee is 10 Kr. or about \$2.50. 'Phone and c.w. are equally permitted; the maximum power is 50 watts.

General:

Membership in the official "They Don't QSL" complaint club is growing YU7VV is the latest addition D4DJC-exD4BOC reports non-QSLing by several stations See also the "Correspondence" section, this issue Send cards for XZA1C in care of

A.R.R.L. Hq. G2OW reports unauthorized use of his call, and requests that the call be ignored if heard during the remainder of 1935; information on the bootlegger is, of course, desired J. S. Nicholson, VU2JP, writes concerning his QRA: "Perhaps you will be interested to know that I am situated at a height of 6450 feet above sea level, and that the position of Munnar is 10.10' N and 77.4' E. The station is a CO-FD-PA affair, with 10 watts to the PA. The antenna is a 1/2-wave Zepp, with 66-ft. 10-inch top and 45-foot feeders. The angle of radiation is low; in fact, it is almost on the horizontal" Harry G. Burnett, W1LZ, claims a record for DX QSL cards received in one batch: 402 cards, weight 4 lbs., from A.R.R.L. 1st district manager Steiger, W1BGY A total of 72 WAC certificates were issued during the month of October; if things hold up, the grand total will closely approach 2000 by the end of the year A new station is F7CGV, located in New Caledonia, worked by K6BUX October 21st The frequency is about 14.3 mc., with a wobbly and creeping d.c. note Any station which has worked VK2FD and not received a QSL card should notify W7CSF Len Moncour, VK3LN, has been making a true "ham's journey" of the United States and Canada, stopping off to see almost every ham he has ever worked QSL cards from these stations are his identification cards; he has been royally received in many places on the long road between Hollywood and West Hartford Manfred Asson, EF2D, of Tartu, Estonia, reports excellent reception of East coast W stations and K4 and K5, with west coast stations being heard frequently Asia and Oceania, too, are received very well; harder are Central and South Africa, with South America the hardest of all Cards for Andorra (PX) should be sent to the U.R.E., Apartado 262, Madrid, Spain T. Okinishi, K6CQV, visited the shacks of 29 Japanese and two Manchurian hams on his recent tour, met a total of 75 That's covering the ground! On Sunday, Oct. 27th, Miss Nelly Corry, G2YL, made WAC on 28 mc. in a little more than 6 hours! Says W1BLO, it looks like the YL ops are showing us up Hi!—and hearty congrats, G2YL This was, incidentally, the first W.B.E. on ten; tnx, G5BP The E.D.R. held its annual meeting Sept. 15th, elected the following officers: James Steffensen, OZ2Q, president; Ahrent Flensborg, OZ1D, secretary; H. T. Petersen, OZ7Z, foreign secretary; W. D. Bowadt, OZ5CC, hon. treasurer; Poul J. Jensen, OZ7GL, QSL manager; and Helmer Fogedgaard, OZ7F, editor "OZ" The E.D.R. now has more than 300 members, and is steadily growing; membership dues were recently decreased from 18 Kroner to

(Continued on page 100)



OPERATING NEWS



Conducted by the Communications Department

F. E. Handy, Communications Manager

E. L. Battey, Asst. Communications Manager

THE SWEEPSTAKES will be in full swing as this copy of QST is delivered to readers. Every U.S.A. and Canadian ham can take part. The badge of entry into the "SS" is merely the adoption of the call CQ SS. If just looking for QSOs without time to spend in more than a passing way on the contest, the use of CQ SS will still bring ample in the way of QSOs and contacts with every corner of North America. It is an achievement to "work all states" and many the ham who completes his collection of cards from the hard-to-get states during one of the big national QSO parties, that have become so well known as the "SS." The "SS" is a thoroughly democratic activity into which every ham on any ham band can enter in as large or small way as he desires . . . just by use of a CQ SS. It is requested that all participants with their reports include suggestions and comments that will be helpful in modifying the arrangements from year to year in line with what the majority want.

We expect that the degree of 'phone participation will be somewhat greater than usual this year since a parallel certificate award to the leading 'phone participant in each A.R.R.L. Section has been announced. While the announcement met with favor, the decision on whether this feature will be discontinued or the 'phone part of the contest curtailed, expanded, or rearranged is yours to make. Reports and reactions from a majority of radiotelephone operators will govern. Special consideration has been given to 'phone activity in this "SS." If this is what you like, let us know. If not, then what would you and do you suggest as a suitable activity?

Personally if we had our choice, the "SS" would run, say, four days only, ending in a Saturday—Sunday period, but we have hesitated to announce such a change fearing this might detract from the success and popular affection in which this and the DX tests are held. Comments on this thought will be appreciated. If so shortened, should the corresponding 40-hour-operating-time handicap be included, or could it then be dispensed with?

The Cairo survey blanks are available to every W or VE ham who wants more frequencies for operating work and is willing to put in some time making observations in the 4000-4500 kc. or 6000-8000 kc. range. Any receiver with a beat oscillator that will cover these ranges or even a substantial part of one range, can be used. A card or message will bring you details.



The League's Cairo Committee (W8CMP, W1KH, W8HC) announce the availability of a new A.R.R.L. button for workers in the cause of amateur radio in the Cairo Preparatory Surveys (4-4.5 and 6-8 mc.) of commercial occupancy. Done in black and gold, the pin is of 3/4-inch diameter and bears the A.R.R.L. diamond.

This attractive button in League colors will be given to amateurs who are doing things regularly in the survey. The new buttons will be carefully restricted to Cairo Observers who actually submit logs of value in connection with the survey, either direct to A.R.R.L. Headquarters, or through one of the group-centers conducting planned work in connection

with the survey. Those who have already won the new League button through consistent surveying will be first to receive the emblems.

DO YOUR PART. Get lined up for survey work to-day if you have not already volunteered. Your acknowledgment card, and a word as to which range you can cover will bring you details . . . and the new League button when your logs in behalf of the cause have been forwarded.

Here's a poser that can be answered by taking part in different operating activities. How is your operating ability? Is your ability to copy through QRM as good as you think it is? If your ear can pick them out then it is a question of how accurately you can copy what you hear! The Navy Day receiving competition brought us a deluge of copies (Honor Roll will appear in an early issue) and showed up inaccuracies. Another test is afforded in THE A.R.R.L. COPYING BEE scheduled for December 27. Six high power stations have been selected to transmit. See the full schedule on page 10. Mark the calendar now. Be on deck. Copy what you can and send it in reporting how the various stations came in at your location. It's lots of fun to try it besides being good practice.

—F. E. H.

Florida QRR Work

Emergency communication work is not new to Florida amateurs. Many times have they been called upon to provide communication when regular channels have failed, and never have they been found wanting. They have always come through. Such was the case during the Labor Day storm this year. Reports of work at various stations follow:

W4COT: This station was on the air 107 hours and was open for storm duty 172 hours and 20 minutes. W4COT in Miami, and W4AKI and W4DMY in the Keys were the only means of communication with the stricken area up to September 6th, and all news items, relief instructions, orders for medical supplies, etc., came through these stations. W4AKI was on the air 36 hours, W4DMY, 14 hours. W4AKI was actually set up for 74 hours and W4DMY for 49 hours. Operators doing duty at the three stations were W4COT/W3KP, W4AKI, W4EB, W4DER, W4CXB, W4CNA, W4CFC, W4BDD, W4CZX, W4DMY, W4MD, D. H. Cross, E. G. Little, George Hill, and C. R. Gray. These men put in a total of 677 hours of duty! All work at W4COT and W4AKI was on 3.9-mc. 'phone. W4COT went on the air September 1st at 7:30 a.m. Reported into the 3.9-mc. 'phone storm net at 8:00 a.m. Copied NAA storm report at 10:00 a.m. Stood by for weather reports all afternoon. Worked W4DLH, W4ACZ and W4AHE and gave latest WX. Transmitted WX several times throughout day and night. September 2nd, W4COT: Sent latest WX at 10:30 a.m. Warned W4DLH and W4CZX to stand by for reports. At 1:33 p.m. called W4CXB and W4DMY to line up relief operators. Later also got W4DER. At 6:45 called W4CZX to warn residents of Redlands district that storm was approaching. Obtained latest WX from state amateur storm net. Electricity was cut off all over Miami at 7:23 p.m. as safety measure; while in contact with W4GQ. Converted receiver to battery operation and continued to copy weather which were relayed by telephone to the proper locations.

This continued all night, with both telephone trunk lines kept busy. No time to eat or sleep and no relief operators. September 3rd, W4COT (his 30th birthday): After daylight transmitting antenna was repaired in heavy gale. Electricity still off. W4AKI was trying to get some sort of emergency power. By noon W4AKI was on the air with emergency 3.9-mc. 'phone, 60 watts. W4COT continued to handle 'phone calls and give WX reports until 5:27 p.m. when electricity was obtained. W4AKI then said he would go to the Keys. W4COT called W4AVQ and reported into the storm net. W4AKI came on at Islamorada about 9:30 p.m. with relief traffic. Contact continued all night. September 4th, W4COT: Continued traffic with W4AKI. Volunteer operators began to report in. . . . COT had been on (the one op) 63 hours!! W4AKI moved deeper into the stricken area, and at 1:15 p.m. contact was established between COT and AKI at Matakumbe Key. Due to a mistaken order of the Coast Guard, W4AKI was not permitted to operate here. At 4:30 p.m. contact was again established with AKI at Tavernier. The COT-AKI hook-up gave the Red Cross answers to messages in 10 to 20 minutes, and several times the Red Cross representative was connected directly with HQ's in Miami by feeding the receiver into the telephone line. This enabled him to give a direct and complete statement and report fully as to conditions at that time. September 5th, W4COT: Continued to contact W4AKI. At dawn Fred Bassett, Jr., owner of AKI, was relieved and returned to Miami after 45 hours of duty. At 2:08 p.m. W4AKI closed down and returned to Miami as other communication (one telephone, and two telegraph lines) had been opened. COT continued to contact stations of the Florida storm network. At 4:30 the Red Cross called to say that commercial communication was unsatisfactory and asked if we would go down to the Keys again. September 6th, W4COT: Continued to contact state storm network. Lined up several operators and a boat (U.N.R. YP-48) for transportation. Boat got under way at 3:00 p.m. and contact was established at 9:00 p.m. Operators aboard were W4DMY and W4MD; the latter had not been asleep since September 1st, so another operator, W4CZX, was sent from Homestead; he arrived Saturday morning after sun-up. September 7th, W4COT: Continued to contact YP-48 (call W4DMY), handling messages for Red Cross and FERA. September 8th, W4COT: Reported on storm net at 8:00 a.m. Worked YP-48 at sea. Off the air at 11:50 a.m. Closed station, met boat, and drove W4CZX home to Homestead, 32 miles from Miami. Approximately 1700 'phone calls were made at W4COT during the emergency period. Approximately 8000 words were handled. Power at W4COT was 200 watts to the antenna. W4AKI, the portable, used batteries to run their generator at the start of work at the Keys, but when they ran out of batteries they commandeered an Austin, jacked up the rear wheel, and ran the generator from it.

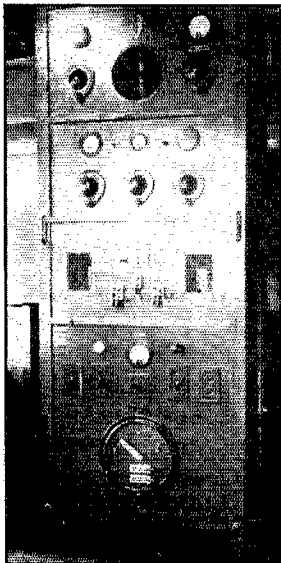

THE TRANSMITTER AT W4AVQ, LAKE LAND, FLORIDA, ONE OF THE LEADING STATIONS IN HURRICANE EMERGENCY WORK EARLY IN SEPTEMBER

W4AVQ: This station went on the air in the Florida 3.9-mc. 'Phone Emergency Network at 7:30 p.m., September 2nd, and went off the air at 11:30 p.m., September 5th. During those seventy-six hours the transmitter was off the air for only four hours; this four-hour absence was due to power supply failure. Weather reports and storm progress reports were gathered from various amateurs in the storm net and forwarded to those concerned. Stations worked by W4AVQ included W4COT, W4GQ, W4CQJ, W4AKI, W4ASR, W4AQU, W4DU, W4AWO, W4WS, N4AFC, W4NN, W4EZ, W4TQ, W4BCZ and W4COS. Information handled at W4AVQ fills eleven single-spaced typewritten letter-size sheets!! Every half-hour schedules were maintained with W4TQ. Sarasota, many messages being handled over this circuit for the Florida Power and Light Co. An every fifteen-minute schedule was kept with W4GQ, Clewiston. An hourly schedule with W4COT was maintained part of the time. Operators at W4AVQ were Francis Wagner, the owner, Robert Touchton and Sidney Gumore. The telephone was kept busy by people calling for information about their relatives. Hundreds of messages were handled for such people as well as regular relief traffic, and press reports. During the disaster the Peninsula Telephone Company extended the special use of two 'phones to W4AVQ, the regular one at the station making a total of three. Data was exchanged with Western Union.

W4WS: This station, as Net Control of the Florida 'Phone Net, A.A.R.S., went on the air at 4:20 p.m., September 2nd, getting barometer readings and helping to plot the supposed course of the storm. At 12:20 a.m. he was called by W4DU, who gave him the SOS message from the S.S. *Dinic*, which had been picked up in Jacksonville. W4WS relayed it through W4GQ and W4AWO to the Coast Guard at Palm Beach. Due to being closer to the storm area W4GQ took over the Net Control position at 6:30 a.m., September 3rd. W4WS continued to stand by, handling traffic to the National Guard headquarters in St. Augustine, giving barometer readings at regular intervals and rendering all assistance possible. Amateurs who assisted W4WS in the operation of his station were W4BGL, W4DDB and W4BIE. W4WS signed off and left the air at 10:00 p.m., September 5th, after a constant watch since September 2nd.

W4ASR: For the period 7:30 a.m., September 2nd, to 6:00 p.m., September 5th, W4ASR was on the air for fifty-two and one-half hours. He slept only six hours and worked at the office twenty-four hours. He relayed important messages to the offices of the Governor, Adjutant General and the Florida East Coast Railway, keeping the channels clear for the portable stations in the field, copying weather reports, transmitting storm information and organizing a portable unit to be taken into the stricken area around Cedar Keys. W4BIN and W4CPW took this unit to that point. There was only one operator available at W4ASR, although valuable assistance was given by the YF, who served meals at the operating table and kept the log. Much important information was relayed for the power companies. W4ASR worked in the 3.9-mc. 'phone band.

W4NN: This station handled Red Cross traffic to Coast Guard headquarters and sent out official weather reports from storm warning headquarters located in Jacksonville. Transmissions were sent every thirty minutes on 3.9-mc. 'phone and 7-mc. c.w. W4NN worked with the Florida 'Phone Storm Net for 45 hours.

W4BIN: When it was quite certain that the storm would hit Cedar Keys on the west coast of Florida, W4BIN and W4CPW loaded BIN's portable rig into a car and headed for that point. They were stopped by the storm within three miles of Cedar Keys. They turned around in a howling 70-mile gale and went back several miles to a small town called Otter Creek. There they put up the antenna and got the rig ready to perk, planning to use 'phone, but found one of the audio transformers wet so went on c.w. Several stations around the state were worked and dope given on the storm. They were on the air constantly until 3:00 o'clock the next morning. They later learned that the telephone line was still up and the storm most over so they headed for home. The rig used was a 3939-kc. 36 oscillator and a pair of 89's in the final, suppressor grid modulated. Receiver was a 36 detector and 37 audio.

W4BCZ: BCZ built and installed WAEZ, commercial, for the Florida Power Corp. and finished installing it at Tarpon Springs one hour before the storm hit. WAEZ was the only communication from that point. W4BCZ also was active with the 'Phone Emergency Net.

CM#WW/CO#WW: This station was on the job starting September 1st, relaying warnings to Florida hams via northern W contacts on 14 mc. On September 2nd high winds were felt in Havana, and preparations were made should the storm hit. The wind got up to about 40 m.p.h. about midnight, but did not get any worse in Havana, although the Florida Keys were being very hard hit. Communication between Key West and Miami was destroyed; along the railroad and on each side were the Western Union land lines and the A. T. & T. lines; both of these lines serve Key West and Havana. On September 9th the Cuban Telephone Co. approached CO2WW to ask if he could establish contact with Miami via amateur radio. A telephone circuit between Miami and Havana was badly needed. CO2WW has a 14-mc. 'phone rig, but advised the officials that, due to skip, he would be unable to work Miami on that frequency. However, he arranged to use his c.w. rig, which operates on 14 and 7 mc. by using the speech amplifiers and modulators of the 14-mc. 'phone hooked to the final of the c.w. rig. Contact was established on September 10th with WNC, the A. T. & T. station at Miami. CO2WW using the special call CTC. The circuit was FB, good reports being received. A schedule was made for 4:00 p.m. when it was expected the channel would be used for regular telephone business. Contact was made at 5:00 p.m., but rather than use the circuit then, new arrangements were made for the next day. At the time set for this schedule word was received from New York to abandon the tests, since a wire had been received for the service. Although no actual commercial use was made of the circuit, amateur radio was on the job and had it been necessary to use the channel "ham radio" would have done it!! FB, CO2WW!

In addition to the stations mentioned in the above accounts, the following are known to have also given valuable cooperation in the Florida emergency work: W4BYY W4ACB W4CVQ W4CLW W4AO W4BGL W4CAM N4AGR W4ADB W4BAM W4JO W4BNI W4DOY W4GS W4AIV W4ANH W4ANU W4BKD W4AUW W4DGG W4DEZ W4BSJ W4DIC W4AXP W4ABK W4SZ W4MS W6MLY/4 W4PL W3AIJ W1GXO W3NK W8BWH W3FJU W1ADM W8ADS W3AWM W3ADQ W2VR W3EHY.

U.S.N.R.: The Naval Communication Reserve station NDL-1 was manned from 2:00 p.m., September 1st, until September 6th at 7:00 p.m., a period of over five days. Except for assistance from three commercial operators, all work done at NDL-1 was performed on a strictly voluntary basis by officers and men of the N.C.R. Several hundreds of messages were handled at the station. Lt. J. H. McKinney was on duty continuously for four days with only "catnaps" for rest. The Naval Reserve watch at NDL-1 started at 2:00 p.m., September 1st, Sunday, at the Federal Building, Miami. On Monday the weather Bureau notified the operators that its teletype circuit to Key West had gone out of action. From that time on the N.C.R. station took all messages that came to the Key West Naval Radio from ships at sea, and relayed them to Jacksonville by W.U. wire, thus filling the extremely important gap between Miami and Key West. In addition, all government and emergency messages were handled. Operators on duty at NDL-1 were Lt. McKinney, Lt. Hoelstel, Ensign Scanlon, Radioman Foley, ex-Navy operators Chafin and Bowman, Warrant Officer Laurant, and commercial operators Schuss, Corrigan and Hart. Mr. Laurant went about 60 hours without sleep!

The work of all operators having any part in the Florida emergency communication work should be an inspiration to every radio amateur. It exemplifies the true spirit of the American amateur and the amateur-affiliated organizations, the A.A.R.S. and N.C.R. The highest praise is due each individual operator cooperating!!

Another hurricane threatened Florida on September 27th and 28th. Although it passed out to sea and did no damage to the Florida coast, it is good to know that again amateurs

were prepared and on the job to serve, had it been necessary. W4ASR was on the air from 6:00 a.m., September 27th, until 2:00 a.m., September 28th, slept from 2:00 a.m. to 6:00 a.m. and came back on the air until 10:00 p.m. at which time it was determined definitely the storm would not hit Florida. Many 3.9-mc. 'phones helped materially in keeping that band clear for emergency traffic. W4ACB manned W4SC, the Florida National Guard station, for ten hours on the 28th, until word was received that the storm had headed out to sea. Contacts were made with both 'phone and c.w. control stations, of the F.N.G. Net. New equipment has recently been installed at W4SC, using 'phone on 3905 and 3940 kcs. and c.w. on 3875 kcs. 3905 kc. is the Florida Emergency 'Phone Net frequency, while 3940 kc. is the National Guard Net frequency. There are six N.G. stations located with as many N.G. Companies at strategic points throughout the state. Among other stations on the job September 27th-28th were W4COS, W4DBQ, W4DU, W4BYY and W4WS, all on 3.9-mc. 'phone.

Just as this issue goes to press another hurricane has hit Florida, on November 4th. Again, Florida amateurs were on their toes. Those known to be actively participating in emergency work were, on c.w. (3875 kc.): W4AWO, W4NF, W4AO, W4BQ, W4AGS, and on 'phone (3905-kc. and other 'phone freqs.): W4GQ, W4AKI and W4DU. Many members of the A.A.R.S. stood watches all evening to give whatever aid possible. Numerous 3.9-mc. 'phones cooperated by clearing the band of unnecessary QRM. Among the many stations cooperating in various ways were W3BKZ, W3SN, W3CXL, W1MK, W1GME, W1KV, W1DFT, W4BYY, W8AOM, VE1EI and W1UE.

DX Notes

IN THE 1931 A.R.R.L. DX contest, W9FM reports that at W9GV they learned that F3 and OA4 sigs came in at about 5:30 a.m., and Europe pounded in about 6:05 or so. In the succeeding 180 days, W9GV worked OH7NB 100 times, very many of these QSO's taking place with no other signals audible at either end! W9TB and W9LJ worked VK's and ZL's about 40 per night on the best nights during the recent VK/ZL contest. W4AKH, with 76 countries worked to his credit, is the new president of the "210 DX Club." W8GAL calls attention to very unusual reception from Africa the first of October. The Africans poured through there on two consecutive nights from 8:00 to 10:00 p.m.!! 6GAL worked ZL1JS (T9, 14350 kc.), and some ZT's on 14-mc., W8's, W3's, etc. working Africa at the same time. No one knows just what surprise the 14-mc. band will spring! 14-mc. DXers anxious for a QSO with the heart of Asia should keep an ear open for U0ND located on the southern shore of Lake Baikal near the Mongolian-Siberian border. When worked at W6GAL he was on 14,360-kc., chirpy n.d.c. note. Another "hard one for 14-mc." was raised by W6GAL on October 30th—CR7GC, d.c. on various frequencies between 14,300 and 14,450-kc. PJ1B, reputed to be with a geology expedition out of New York working in the wilds of Curacao, was worked by W6GAL recently; he was on 14,400-kc., p.d.c.

W3AYS sends some dope on "locations," which should prove helpful: YM4ZO is on the high end of the 14-mc. band, YM4AF about 15-kc. inside; YM4ZO T7, YM4AF T9, ZS6AF is c.c. on about 14,380-kc.; YL2BB T6 on about 14,290-kc.; F8SCR T5 on about 14,300-kc.; CR7GC on about 14,350-kc. TS. YN1AA was worked by W3AYS. On October 12th and 13th W3AYS heard VS6AQ; from 7:59 to 9:45 a.m. EST Q5 R6-9 on Oct. 12th and from 7:45 to 8:45 a.m. EST with same report on Oct. 13th.

VE1EP/VE1HG have worked 70 countries and have not yet had an Asian QSO! Record? The input was 25 watts for 53 of them, and the rest added with a new 90 watt rig. W8BKP worked VU2CQ on 14-mc. October 26th and recently heard KAIAN at 12:45 p.m. EST. An unusual one: W8BKP worked VK4EI on 14-mc. October 29th at 11:45 a.m. W2AJR reports a QSO with CTAP, a Portuguese submarine, *Golfinho*, while anchored at Lisbon; QSO was on October 11th at 6:20 p.m. EST, frequency 7-mc. KAILB

on 14,295-kc. and KAICM on 14,255-kc. are anxious to QSO South America. They have heard S.A. stations between 0400 and 0800 GT and will be on during those hours every Saturday and Sunday hoping to contact.

W2EGQ is now engaged in radio sales and service work in Spain and will be there for one year. He took his 59 Tritet, 46 doubler, P.P. '10 rig along with him, and although unable to secure a license, has set his rig up at EA1BU and is on the air daily. He operates chiefly on 7297-kc. and during a month's working has made 129 contacts with U.S.A. hams. He also operates on about 14,300-kc. occasionally. W3CHG reports the QRA of CR7GC as Box 11, Inhambane, Mozambique; 3CHG worked him on September 25th and says he is using 11 watts! Did anyone work CR7GC prior to September 25th? W3CHG reports Africans coming through fine since middle-September; he says they start coming through about 3:00 p.m. EST and last until about 6:00 p.m., on 14-mc. QRA of ZE1JS: Box 700, Bulawayo, So. Rhodesia. From August 1 to October 1 W3CHG worked 21 new countries, mostly Asians and Africans.

3500-kc. is looking up again for DX. Not much has been heard about 3.5-mc. DX working since the excellent '34-'35 winter season. Now W8CNC comes forward with the news under date of October 18th that since September 14th he has heard 49 VK and ZL stations on 3.5-mc. He has worked VK3WO, VK2KR, VK3HG and ZL2GN, VK3HG and VK2KR putting in 85 to 87 signals! G6RB and PA0ASD are again on "eighty." G6RB was recently worked by W8CNC, W9AUT, W8EUY, W5CEZ and W8DCI are also working VK and ZL on 3500. Better get the rig primed for the G 3500-kc. contest, OM's.

W8BKP lists several good DX calls coming through well on 14-mc.: VS2AG T9, 14,395-kc.; UOND n.d.c., 14,360; VS3AC T9, 14,390; PK4XM n.d.c., 14,250; PK3LC T9, 14,015; VS6BD T9, 14,310; PK4RF r.a.c., 14,300; VS6AX d.c., 14,330; AR8MO d.c., 14,400. W8BKP reports VU2CQ coming through regularly around 8:00 a.m. EST. Countries worked at W8BKP now total 143; he is using a single 800 with 150 watts input. W9FM says of W6CUH's DX chart in November QST: "That time for raising VK's and ZL's is for the first 3 hours after sunrise in Australia or New Zealand—the all-daylight path, the logical one. It is 2:45 to 6:00 p.m. CST, 2045 to 2400 GMT. In fact the 0300-0500 time given was 0300-0900 one Saturday in October, not much less on the adjacent two." Re the 14-mc. freak reported by W9LBB in November QST DX Notes, W9FM reports that on September 29th at 5:15 a.m. CST he heard a W8 call D4LTN, and heard G6NJ working a W2, and saying that he was the earliest WQSO the G6 ever had. W9FM then heard the other side (W2) of the QSO, the W2 saying that G6NJ was the only sig on the band. There were no other sigs heard at W9FM but those three. An interesting observation by W9FM after using a beam is that 14-mc. signals from VK's apparently travel the short night path. W3EVW has made WAC, WBE and worked 75 countries in 14 months on the air, using an RK-20 final; he has also worked all states but Vermont, and all Canada but Yukon.

ABOUT TUNING DX

One of the greatest questions in DX tuning, especially during a DX contest, is "where is that feller going to start tuning—is he going to listen near my frequency?" I have a suggestion which involves using the international abbreviation QSX—"I will listen for . . . on . . . kc." On finishing a QSO a station could send "QRZ? QSX 14,300 de K4XX," or cut it down to just "QSX 14 300" indicating approximately where his receiver is tuned, and only stations close to that frequency need bother to call—the rest have little chance. Or, when there is not a long waiting list of fellows ready to call, use one of these:

QLM—"I will tune from the low frequency end across the middle."

QML—"I will tune across the middle toward the low frequency end."

QHM—"I will tune from the high frequency end across the middle."

QME—"I will tune across the middle toward the high frequency end."

These are easy enough to remember. Just keep in mind "low, middle, and high" using the proper initials to indicate. The use of "middle" seems to some to be a complication, but permits tuning from the middle, giving the fellows in the middle a chance and making four "edges" in each band for the W stations to pile up into, instead of two as now seems to be the case! It should help to scatter the stations rather than force them to concentrate at the two outer edges and fight it out.

During the 1935 A.R.R.L. DX Contest, ZE1JB used these abbreviations, saving plenty of time and QRM. Once, from around 14,300-kc., he used QLM, at which W1SZ raised him at 14,001-kc., followed directly by W9FM; both had been at the other end, made a quick change and a successful, short call. In the recent VK-ZL contest, ZL2KK used QHM frequently and could be raised on three calls and one sign! Let's all use these apparently underestimated Q signals regularly.

—E. H. Conklin, W9FM

DX Time Table

(For Eastern North America)
Fall and Winter, 1935-36
By WITS

14 MC. 7 MC.
(GT) (GT)

EUROPE:

(Eastern) CT1, CT2, CT3, D, EA, EI, F, G, GI, HB, ON, PA, TF, YM, ZB. 1100-1300 & 2400-0400
1900-2300

(Western) ES, HAF, I, LA, LY, OE, OH, OK, OZ, SM, SP, SX, U, YL, YT, YR. 1000-1200 & 0100-0500
2000-2400

AFRICA:

(North) CN, EAS, EA, FA, FT, SU. 1100-1300 & 2400-0400
1900-2300

(Central and South) CR7, FBS, ON4, VQ2, 3, 4, 5, 8, ZD, ZE, ZS, ZT, ZU. 1100-1300 & 1800-2000
(Also around 0400)

SOUTH AMERICA: CE, CP, CX, HC, HJ, OA, PY, YV, ZP. 1100-1200 & 2100-0700
2100-0100

ASIA:

(Western) AC, XU, J, MX, VS6. 1100-1400
(Eastern) AR, YI, ZC. 2000-2300

OCEANIA: F7, K6, KA, OM, PK, VK, VR4, VS1, 2, 3, 5, 7, 8, ZL. 1100-1300 0500-1200

NORTH AMERICA: CM, F3M—, HH, HI, HP, HR, K4, 5, NY, TG, TI, VP1, VP2, 4, 5, 6, 7, 8, YN, YS. 1000-1300 & 2100-0900
2100-0200

The above are best times only. On monthly DX peaks, a considerable extension of the above times can be expected. For example, on 14-mc. Europe lasts from 1330 to 0200 GT without a break during peak conditions. 7-mc. is not quite as affected in this way because it is less critical as is well known.

Correction Re 28-Mc. Contest

Full details of the 1936 10-meter contest were given on page 56 of November QST. We wish to call attention to the error which appears in the detailed rules in the paragraph numbered (6). It is stated that in computing final score a competitor may claim points for each different station worked once during each calendar week. This should read, ". . . during each calendar month." It was stated later in this announcement that monthly contacts with the same sta-

tions will be permitted to count, and that is the correct version.

A bronze charm will be presented by the A.R.R.L. engraved "FOR 28-MC. ACHIEVEMENT, 1936," and with the call of the winner. One point will be scored for each completed 100 miles of contact. Decision between W/VE competitors will be based on weighted credits. (1) The number of weekly reports to A.R.R.L. on 28-mc. work, 25%. (2) Description of equipment, and development work reported on same, 25%. (3) The number of points scored (monthly contacts with the same stations will be permitted to count), 50%. W/VE entries must be received at A.R.R.L. on or before January 15, 1937. Report your results each week to A.R.R.L., and submit scores and log at the end of the contest if you wish these to count for all awards.

Starting January 1, 1936, this International 28-mc. Contest will be in progress for one year, concluding at midnight December 31, 1936. This is open to all W/VE hams. The A.R.R.L. will award a bronze medallion to the highest scoring United States or Canadian operator-experimenter.



Mr. Hunter's article wins the C.D. article contest prize for this month. Each month we print the most interesting and valuable article submitted in connection with the article-contest. Contributions may be on any phase of amateur operating or communication activity which adds constructively to amateur organization work. Prize winners may select a 1936 Handbook six logs, six message files, six pads blanks, or equivalent credit toward a combination of A.R.R.L. supplies. Let's have your article. Mark it "for the C.D. contest," please.
—F. E. H.

On Rag Chewing

By Ralph F. Hunter, W2AKH*

ONCE upon a time, not so many years ago, there was an unusual organization known as the "Rag Chewers' Club," whose members became acquainted with a gentleman known as the "Old Sock." Now it seems that the time has come for a revival of the ideas which the club and the "Old Sock" represented.

From time to time articles appear showing us better ways of operating our stations and making the most of our hobby. But rag chewing is another phase of the game which too often is neglected. Too often a QSO consists of only the audibility report, QRA, WX report and perhaps a short description of the layout. Short and snappy operation on the part of the ardent traffic handler is of course the sign of the good operator. However, in too many cases a hookup is terminated with "CUL 73" and the stations involved proceed to make similar QSO's apparently with the idea of working everybody on the band and not saying much to anybody, or handling traffic either.

So it seems that a few suggestions are in order. It is hard to lay down rules on what to talk about since that is so much an individual question. But it is easy to point out some things which have often been overlooked, many of which may seem a bit fantastic but all of which are practical.

No one can deny that the amateur fraternity is a great group, made up of many types of men and interests. Within its ranks are men and women representing all walks of life. It seems a bit odd that operators representing like professions do not get together. For instance, why does not the doctor or lawyer know more operators who are also doctors and lawyers? Surely keeping contact with those of his profession via amateur radio and discussing their common problems should be mutually beneficial.

Amateur radio itself probably will always be the one big

*12 North St., Catskill, N. Y.

source of conversation. There are hundreds of things to be said regarding our transmitters and receivers, QRM, experimenting, antennas good relay nets, Naval Reserve, Army Amateur work etc. We all know that when a real radio "nut" gets loose he needs no suggestions regarding rag chewing.

Let us not forget though that amateur radio is not the only hobby in the world. Just as one example there are the amateur telescope makers. Now anyone who has spent many hours grinding and polishing a telescope mirror has plenty to say about it! Then we have some "eccentrics" who delight in collecting stamps and old coins. Here's a chance to swap dates. It is our suggestion that these groups make some attempt to get together and discuss their hobby.

We also have those who love to become reminiscent and who think that there is nothing like the "good old days." It is improper here to discuss the pros and cons of the questions but many such can furnish a lively topic for conversation on the air, especially among the old timers.

Let us then have bigger and better rag chews. Indeed is not the promotion of friendly intercourse between ourselves and other nations one of the very foundation stones of amateur radio?

VE9CNE-Canadian National Exhibition

Amateur radio station VE9CNE was in operation at the Canadian National Exhibition at Toronto from August 23 to September 7, 1935. During this period 1039 messages were handled! All work was on the 3.9- and 14-mc. 'phone bands. The station had 280 QSO's in all U. S. districts, VE1, 3, 4, HI, VO, F8 and CO. The three operators were VE3KX, VE3UY and VE3DJ. Approximately 100 hams signed the visitors' log, coming from VE1, VE3, W2, W8, VE2 and W9 districts. Several listeners' reports were re-



VE9CNE, AMATEUR STATION AT THE CANADIAN NATIONAL EXHIBITION, TORONTO, AUGUST-SEPTEMBER 1935

The three operators, left to right: Sandy MacArthur, VE3KX, Truman Locheed, VE3UY, Jack MacArthur, VE3DJ. VE9CNE was equipped by VE3UY (transmitter at the left) and VE3HC (transmitter at the right).

ceived from "across the pond" on the 14-mc. 'phone. Schedules were kept with VE3WB, VE3YD, VE3NC, VE3ACL, VE3ZV, VE3AU, VE3JT, W8KWA, W8NNR/W8CDK, W8GUF, VE3RK and VE3NX. The majority of the traffic being handled through these stations. Two transmitters were in use at VE9CNE, one furnished by VE3UY and one by VE3HC. VE3HC's rig consisted of 800 class B modulating 800 in the final on 3.9-mc. VE3UY's used Eimac 50-T in class B modulating 50-T's in the final

BRASS POUNDERS' CLUB

(September 16th—October 15th)

Call	Orig.	Del.	Rel.	Total
W6LBM	108	1358	180	1646
W2BCX	43	173	1335	1551
W3EOP	63	41	1122	1226
W5CEZ	53	91	1062	1206
W5MNT	—	—	1068	1098
W6KFC	4	16	914	934
OM2RX*	268	187	341	796
K6FRB	235	149	357	741
W3NLF	—	4	690	702
W9ALJ	59	42	600	701
W7BKQ	—	9	674	692
W2CHK	196	191	302	689
W9LEZ	51	71	539	661
W2GGE	17	90	492	599
W6HDV	103	168	320	591
W3SN	49	131	410	589
W2EYQ	150	177	240	567
W7NH	9	9	517	535
W2BNJ	486	19	6	511
W9HJC	—	—	511	511
W8DVC	7	22	476	505
W3EZ	60	72	370	502
W5EEW	29	110	362	501

MORE-THAN-ONE-OPERATOR STATIONS

W9BNT	583	628	901	2110
KA1HR*	444	370	590	1404
KA1HR	383	382	476	1241
K6EWQ	9	289	407	705
W5OW	—	—	671	671
W5DNE	444	16	47	507

These stations "make" the B.P.L. with totals of 500 or over. Many "rate" extra credit for one hundred or more deliveries. The following one-operator stations make the B.P.L. for *delivering 100 or more messages*; the number of deliveries is as follows: Deliveries count!

VE3QK, 326	KALIG*, 135	W9DDE, 113
W6CCK, 212	KALIG, 132	W3EOL, 103
W6HGQ, 137	W6GLD, 120	W3BWT, 103

A.A.R.S. STATIONS

Call	Orig.	Del.	Rel.	Total
WLMI (W6GXM)	131	227	479	837
WLNF (W2BCX)	22	155	628	805
WLML (W3NF)	16	24	743	783
WLNK (W2DBQ)**	7	114	40	161

MORE-THAN-ONE-OPERATOR STATIONS

WLM (W3CXL)	203	206	1640	2049
WLU (W9BNT)**	40	163	14	217

A total of 500 or more, or just 100 or more deliveries will put you in line for a place in the B.P.L.

* August-September.

** B.P.L. rating on deliveries.

VE9CNE set a new record for traffic handling by voice and the snappy procedure used will long be remembered by all who listened to the operators clearing the hook. Well done, OM's!

Sweepstakes Dates

In the announcement, page 38 November QST, the starting time and ending time were inadvertently set one day earlier than customary. This year the "SS" starts on Friday morning, November 22nd, and ends Sunday morning, December 1st, instead of carrying over to Monday morning as in past years. Due to the prominence of the QST announcement it has been considered inadvisable to change the period of the contest so it remains as per the box announcement, which is equally fair to everybody. Any "SS" contacts after 4 a.m. E.S.T. (1 a.m. P.S.T.) December 1st will be deleted from scores.

VE1 QSO Contest

A. M. Crowell, VE1DQ, SCM Maritime Section, A.R.R.L., announces a "VE1 QSO Contest," open to both 'phone and c.w. stations, and for VE1 contacts only. All

VE1's are invited to join in the contest, which starts at 6:00 p.m. A.S.T., December 15th, and ends at Midnight A.S.T., January 14th. Scoring is as follows: For each VE1 QSO on the 3.5-mc. band—10 points; for each VE1 QSO on the 7-mc. band (outside of 10-mile area)—20 points; for each VE1 QSO on the 14-mc. band (outside of 10 mile area)—40 points. This contest is held under the auspices of the Halifax Amateur Radio Club, and a copy of complete log must be submitted to that club not later than January 20th. Reports must be mailed to the secretary, VE1FN, Coburg Road, Halifax, N.S., Canada. A large *loving cup* will be awarded to the highest scorer.

The Ohio Regulars

The Ohio Regulars, an organization of Ohio O.R.S., is keeping a regular watch of 3710 kc. each evening from 6:00 to 8:00 E.S.T. for Ohio traffic. The station on duty calls "CQ Ohio Tte" and combs the entire band for replies. The Regulars, with W8IAW, R.M., as Control Station, is connected directly with A.R.R.L. trunk lines and provides a reliable delivery and traffic feeding system for them in addition to prompt clearing of intra-state traffic. In addition to traffic work the Regulars hold round-table discussions over the air. A regular bulletin is issued to the gang by W8MH, R.M. and W8IAW. It is hoped that eventually all Ohio Regulars will operate on the spot frequency of 3710 kc. When you have Ohio traffic, tune to 3710 kc. at the specified time and look for any of the following stations, members of the Regulars: W8IAW W8MH W8ISK W8AQ W8BKE W8CIO W8EME W8FGA W8GSO W8HCS W8LET W8INT W8TR W8JFZ W8KIM W8LCY W8LZK W8MQC W8MQO W8MXH W8NAL W8WE W8VP W8UW. By making use of the 6-8 p.m. 3710-kc. watch, you will have direct connections to all parts of Ohio.

Florida A.A.R.S. 'Phone Net

W4WS is Net Control of the Florida 'Phone Net, A.A.R.S. At the present time this net has 14 active stations. It was organized in 1930 and is believed to be the first 'phone net in the A.A.R.S. Much excellent work has been done by these Florida stations during numerous storms. Attention is called to the splendid work done in the 1935 Labor Day Florida hurricane emergency work!

Carnauba Expedition—KHAFAQ, 6210 kc.

The Johnson's Wax Carnauba Expedition left Miami on October 1st on an aerial exploration trip into the wilds of northeastern Brazil in a Sikorsky Amphibian plane, *Carnauba*. The *Carnauba* will be gone two and a half months with officials of the Johnson company and scientists from the Chicago Field Museum. Ensign J. A. Hoy, U.S.N.R., is with the party as co-pilot and radio operator. KHAFAQ is the call assigned to the expedition. Besides working on aircraft frequencies, permission has been granted to contact amateurs on 6210, 12,420, 5520 and 11,040 kc. It is expected that 6210 kc. will be used mostly for work with amateurs due to its proximity to the 7-mc. amateur band. QSL cards will be sent to all amateurs worked. Arrangements have been made with F. Lee Dechant, W9QC and Stanley Fisher, W9DJE, for regular communication. Listen for KHAFAQ, especially on 6210 kc., and report all reception and contacts to A.R.R.L., please.

Andes-Amazon Expedition

W2DXO and W2AHC are maintaining schedules with Ecuador (HC1FG) for contact with the 1935-36 Andes-Amazon Expedition, of which W2DPQ is radio operator. These schedules are kept every Tuesday night at 10:30 EST on 7 mc. The main purpose of the Andes-Amazon Expedition is to try to establish contact with a tribe called the Ssabela Indians. Practically nothing is known of these people and there is no record of a white man having entered their country. Further interesting details of the findings

of the expedition are expected as the W2DXO/W2AHC schedules progress. Everything of interest to amateurs will be passed along through the pages of QST.

Amateurs Contact U.S.S. Minneapolis

Communication Reservists in the 12th Naval District were given the unusual opportunity on Navy Day, October 27th, to establish two-way communication with the U.S.S. *Minneapolis* in San Francisco Bay. Arrangements, which made possible contacts with the *Minneapolis* by seventy-seven radio amateurs (all members of the Naval Communication Reserve), were completed by Lt. Sydney J. Fass, U.S.N.R., W6NZ, NACF, the *Minneapolis*, transmitted on 3475 kcs., the N.C.R. amateurs using various frequencies in the 3500-4000-kcs. band. Practically all amateurs used the frequencies assigned to their particular sections of the N.C.R. in the 12th Naval District. A time schedule for contacts with each section was adhered to. Naval procedure was used for all communications. A special QSL card was designed particularly for acknowledgment by NACF of all QSO's. Each Reservist working the vessel sent a message of greeting, which contained his address to facilitate the sending of QSL cards. Amateurs of the 12th Naval District are located in California, Nevada, Colorado and Utah. This was the first time that Naval Reservists of any district have been given the chance to make direct two-way contacts with an actual Naval vessel on such a wide scale, and the unique experience provided a thrill for all concerned!

W6EAN Aids Expedition

Considerable assistance has been rendered the Fairchild Aerial Surveys Colorado River Expedition by W6EAN, Herschel Calvert, Pasadena, Calif. The expedition, engaged in a field survey for the United States soil conservation service, carried radio equipment operating under the calls KBAY (base station at Milford, Utah) and KBAZ, a portable. These stations operate outside the 4000-ke. end of the 3.5-mc. band. W6EAN uses 3.9-mc. 'phone. Regular evening schedules were maintained by W6EAN, conditions encountered by the expedition being followed by the nightly schedules. On one night's contact KBAZ reported bad weather, high water, illness in the party and other serious difficulties. The W6EAN contact made possible an immediate request for additional help and supplies, which was speedily complied with by Survey headquarters. To W6EAN goes the commendation due all amateurs who perform the kind of services that perpetuate amateur radio! FB, OM!

"I Like the Old Way Best"

"Telegraphin' ain't what it used to be. This here editor learned the rudiments of hamography back in the days when men was men and made their own dots. Nowadays everybody's got a splatterbug with no weights on it and the guy that's waggin' it don't no more know what it's going to make than you do. The race is on to see who can splatter messages around faster and sloppler than anybody else. You set there tryin' to git a message from some mug. You git the preamble by intuition, guess work and the Grace o' God. He hits the address, eyes a-rollin', bug a-smokin', goin' to town. The first time through the address he don't even try to make it right as he knows he's going to go back and repeat it. The second time through he slobbers it up and has to go back and repeat it a third time, and then you sorta strike a average and say to yourself well he made it that way once and this way twice so I reckon it's this way so you put down what he made it the most and then you look in the Postal Guide and there ain't no such town in the Postal Guide or nowhere else so you throw the blamed hamgram in the wastebasket where it might as well have been put in the first place. In the old days when the script called for a a or a b or a c, wye you simple hauled off and made a a or a b or a c, as the case might be, and, having made it you stopped fooling with that letter and proceeded to the next one. And nobody repeated nothing. They done it right the first time. I like the old way best."

—W4IR, in his "Dixie Squinch Owl."

The Day Before Christmas

By Robt. H. Votaw, W7WY*

'Twas the day before Christmas,
And all through the shack
None of the floor could be seen—
Not even a crack!
For traffic was plastered
Knee-high on the floor,
And every few minutes
'Twas "QTC more."

The poor op. was sweatin'
O'er "mill" and o'er "stick"—
Couldn't finish one asked
Before his next "trick."
After QSG 5—My gosh!
What a shock!
"QRM," says the other guy,
"Put in that other 'rock.'"

Three hours later
He leans back with a groan,
Thinking, at last,
He has some time of his own. . .
But, "CQ, CQ North"
Comes the far-away cry—
The op. tunes him in
With blood in his eye. . . .

Some time later
He pauses to stare—
Hark! The tinkling of bells
Floats out on the air!
Can it be Santa??
Oh, boy! What a sight!
"Ye gods! 'Tis the alarm clock—
I've been working all night!"

* Route 1, Box 398, Vancouver, Wash.

ELECTION NOTICES

To all A.R.R.L. Members residing in the Sections listed below:
(This list gives the Sections, closing date for receipt of nominating petitions for Section Manager, the name of the present incumbent and the date of expiration of his term of office.) This notice supersedes previous notices.

In cases where no valid nominating petitions have been received from A.R.R.L. members residing in the different Sections in response to our previous notices, the closing dates for receipt of nominating petitions are set ahead to the dates given herewith. In the absence of nominating petitions from Members of a Section, the incumbent continues to hold his official position and carry on the work of the Section subject, of course, to the filing of proper nominating petitions and the holding of an election by ballot or as may be necessary. Petitions must be in Hartford on or before noon of the dates specified.

Due to resignations in the Alabama, Southern Texas, Virginia, and Northern Minnesota Sections nominating petitions are hereby solicited for the office of Section Communications Manager in these Sections, and the closing date for receipt of nominations at A.R.R.L. Headquarters is herewith specified as noon, December 16, 1935.

Section	Closing Date	Present SCM	Present Term of Office Ends
Alabama	Dec. 16, 1935	L. D. Elwell (resigned)
Southern Texas	Dec. 16, 1935	Bradfield A. Beard (resigned)
Virginia	Dec. 16, 1935	Neil E. Henry (resigned)
Northern Minnesota	Dec. 16, 1935	R. L. Rode (resigned)
Saskatchewan*	Dec. 16, 1935	Wilfred Skalte	June 15, 1934
San Diego	Dec. 16, 1935	Harry A. Ambler	Oct. 20, 1935
Oklahoma	Feb. 10, 1936	Carter L. Simpson	Feb. 15, 1936
Alberta*	Feb. 10, 1936	J. Smalley, Jr.	Feb. 18, 1936
Montana	Feb. 10, 1936	O. W. Viers	Feb. 18, 1936
Philippines	Mar. 10, 1936	N. E. Thompson	Mar. 15, 1936

* In Canadian Sections nominating petitions for Section Managers must be addressed to Canadian General Manager, Alex Reid, 169 Logan Ave., St. Lambert, Quebec. To be valid such petitions must be filed with him on or before the closing dates named.

1. You are hereby notified that an election for an A.R.R.L. Section Communications Manager for the next two year term of office is about to be held in each of these Sections in accordance with the provisions of By-Laws 5, 6, 7, and 8.

2. The elections will take place in the different Sections immediately after the closing date for receipt of nominating petitions as given opposite the different Sections. The Ballots mailed

from Headquarters will list the names of all eligible candidates nominated for the position by A.R.R.L. members residing in the Sections concerned. Ballots will be mailed to members as of the closing dates specified above, for receipt of nominating petitions.

3. Nominating petitions from the Sections named are hereby solicited. Five or more A.R.R.L. members residing in any Section have the privilege of nominating any member of the League as candidate for Section Manager. The following form for nomination is suggested:

Communications Manager, A.R.R.L.
38 La Salle Road, West Hartford, Conn. (Place and date)

We, the undersigned members of the A.R.R.L. residing in the Section of the Division hereby nominate as candidate for Section Communications Manager for this Section for the next two-year term of office.

(Five or more signatures of A.R.R.L. members are required.) The candidates and five or more signers must be League members in good standing or the petition will be thrown out as invalid. The complete name, address, and station call of the candidate should be included. All such petitions must be filed at the headquarters office of the League in West Hartford, Conn., by noon of the closing date given for receipt of nominating petitions. There is no limit to the number of petitions that may be filed, but no member shall sign more than one such petition.

4. Members are urged to take initiative immediately, filing petitions for the officials for each Section listed above. This is your opportunity to put the man of your choice in office to carry on the work of the organization in your Section.

—F. B. Handy, Communications Manager

ELECTION RESULTS

Valid petitions nominating a single candidate as Section Manager were filed in a number of Sections, as provided in the Constitution and By-Laws, electing the following officials, the term of office starting on the date given.

Vermont Forrest D. Drew, WIBJP Oct. 20, 1935
In the Missouri Section of the Midwest Division, Mr. J. Dewey Mills, W9CJR, and Mr. Robert A. Hathaway, W9GTR, were nominated. Mr. Mills received 110 votes and Mr. Hathaway received 57 votes. Mr. Mills' term of office began October 15, 1935.

Central California Net

W6LLW, Route Manager, Santa Clara Valley Section, A.R.R.L., announces the "CCN"—Central California Net. Members include W6LLW, Salinas, 3568 kc.; W6FYW, Paso Robles, 3657 kc.; W6ITU, San Jose, 3545 kc.; W6HH, Oakland, 3535 kc.; W6KMQ, Berkeley, 3810 kc.; W6LMD, Sonoma, 3570 kc.; and W6JAT, Yosemite, 3525 kc. More stations will be added later. Schedules are maintained every Tuesday, Thursday and Saturday night. Each station is assigned certain towns and is responsible for QSP and deliveries to those points. The aim of the "CCN" is 100% coverage of central California. "CQ-CCN" is the call to use when wishing to raise net members.

National Highlights

EMERGENCY work is probably the most outstanding highlight this month. Attention is called to the excellent performance of Florida amateurs during recent hurricanes in that state recounted elsewhere in Operating News. The Butte (Montana) Radio Club and Butte U.S.N.R. operators stood by to help during the Helena earthquake in case regular communication became disrupted. W2HXT, W9ISG and W9DBJ were ready to cooperate with amateurs in storm-stricken Haiti and stood watches on 7 mc. to render whatever assistance possible.

The amateurs of Oklahoma City are making an intensive drive to clean up key clicks and prehistoric signals. A nationwide movement of all amateurs in this direction would not be amiss at this time! W3COT, Haddonfield, N. J., has inaugurated a transcon 'phone route, which has outlets in Hawaii and P. I. The route runs W3COT, W9KFA/W5AXA, W6FQY/W6FRW. The South Jersey Traffic Net is now in operation each Sunday at 9:30 a.m. W3DQO schedules K5AG and K5AM four times weekly and invites Canal Zone traffic. W3EDA, College Campus, Easton, Pa., is organizing an all-college net. Ohio O.P.S. swung into action on October 20th with an FB round table QSO. Those present were W8HC, Central Division Director, W3DXB, W8BYF, W8EMV, W8KNF, W8MNN, W8JTI, W8ODI, W8OGK and W8CIO.

W8CSX, Pontiac, Mich., and W8AOM, Buffalo, N. Y., have had over 140 QSO's on their weekly schedules. Two Michigan state spot-frequency nets are now in operation;

the Upper Peninsula Net (W9) being on 3630 kc., the Lower Peninsular (W8) on 3656 kc. W8DVC, Chief R.M., W9PDE, Asst. S.C.M., and W9RHM, R.M., work together in trying the two nets together. The North Dakota Section has inaugurated a North Dakota bulletin via W9JZJ on 3971-kc. 'phone at 12:30 p.m. every Sunday. News of interest to all No. Dak. hams is transmitted on these weekly schedules. W3EZ, S.C.M. E. Penna., says, "High power does not make a good operator, but regular practice does. O.R.S. and O.P.S. are the highest skilled operators in the country. Are YOU in that class? If not, why not?"

W2FF, New York City, recently had a three-way 14-mc. 'phone QSO with G5NI and G5ML. The Tennessee State Traffic Net is rapidly taking shape under the leadership of W4CXV, R.M. and W4BBT, S.C.M. Amateur radio was represented at the Tennessee State Fair by W4DKW; considerable traffic was originated. The Northern New Jersey O.R.S. held a meeting on October 4th; a plan was outlined for an N.N.J. net. W9FRC is 1935 winner of the Kansas Wouff Hong Trophy, awarded to the outstanding Kansas amateur each year. W9KEI, St. Louis, is new Missouri station on A.R.R.L. Trunk Line "E." W9DHN took a message from W6EAR addressed to W9EFA and made direct delivery within eight hours. Speed and service combined! Dick Watson, W1BGL, operator with the Byrd Expedition, recently gave a talk at the Great Bay Radio Club, New Hampshire.

56 mc. continues to be put to unique uses! We have heard of several instances lately of hams out driving, running out of gas, utilizing their 56-mc. portables to "call for help" and have fuel brought out to them. W1FTR, W1IEG and W1IPU were the hams who put too much faith in the "gas indicator." The Kentucky spot-frequency net on 3810 kc. is now in full swing, connected with similar nets in Ohio and Tennessee. W1CAB received a message from Shanghai from a W7 on 14 mc., destined for Washington, D. C., promptly shifted to 3.5 mc. and completed relay. Is your set capable of speedy band change? W1ABG is new S.C.M. in the Eastern Massachusetts Section, replacing W1ASI, who completed a long term.

The winner of the Washington State Progressive Contest will receive one of the famous, hand-made, W7UE fish-twine belts. Washington QSO Parties are held on the third Sunday of each month, 8:00 a.m. to 8:00 p.m. W7EJH was on the air during the Western Washington Fair at Puyallup. W6JAT, who is located in the high Sierras near Yosemite Valley, sports an antenna 800 feet long! KAIAN and KALAK on 14-mc. 'phone are making good DX records; KAI1B and KA1CM on 14-mc. c.w. also offer a chance for P. I. contacts. W7ASQ, Montana R.M., is on the air for traffic from 6:30 to 7:30 p.m. every evening on 3790/3640 kcs. W6ZX reports there are now 80 members in the 7294-kc. Club. The Mountaineer Amateur Radio Association, West Virginia's floating club, held its September meeting in Parkersburg; between 75 and 100 amateurs and friends were on hand. The Roanoke Division is 100% for the floating club idea, with one in Virginia, North Carolina and West Virginia.

Amateurs of the Sacramento Valley Section, several hundred in number, were guests of Mr. and Mrs. W6ATP at a hamfest in Auburn, Calif. It was acclaimed the outstanding event of the year in that Section. W6IGA maintains schedules with K6MEG, W6JZJ with K6DV, 56-mc. activity is at a peak in the San Francisco Section. K7DEV has schedules with K7DYU and K7EGC, who pass traffic to the States via W7APS and W7DBG. Traffic for San Francisco? W6KNI is looking for S. F. traffic at 10:00 a.m. PST each Sunday; he uses 7087 and 7193 kcs. The Virginia 'Phone Net operates in the 3.9-mc. band every Sunday from 1:30 to 2:30 p.m. W9FYU, president of the Central Colorado Radio Association, recently called a meeting to order via 56 mc. from his home, and then kept in touch with them via mobile 56 mc. until he arrived at the meeting place. Army and Navy amateurs each conducted a meeting for the Utah Amateur Radio Club.

A.R.R.L. Trunk Line "D" is operating net fashion on 3865 kc. with W4DS as eastern control. This trunk gives daily service to P. I., Hawaii, Cuba and Guam, as well as to all southern states. W6KOL, Arizona Trunk "D" station,

listens daily for calls at 6:45 a.m. MST to collect traffic for the route. W6DNE and the gang at Sherman, Texas, put on a very successful ham exhibit at the local fair; much operating was done, traffic reaching B.P.L. proportions. The Maine Message Pushers, an organization famous for high totals several years ago, is being revived by the S.C.M. and R.M.'s. Mort Miller, W6HEW, has signed as radio operator on the Yacht *Adventurer*, sailing in early January for a two- to three-year cruise around the world. For clearing traffic to New Hampshire, W1FFL, R.M., is on 3735 kc. each evening at 6:00 p.m. looking for incoming messages. W9NNM, Iowa City, has replaced W9LEZ as Iowa Trunk Line "G" station.

The Guadalupe Valley (Texas) Radio Club will hold its annual "blow-out" on December 18th. Many prizes are promised; everyone invited. Address W5EUO, R.M. Mills, 201 Clinton Street, Cuero, Texas, for reservations (\$1). W2EYQ, R.M., NYC-LI, is organizing a Suffolk County Traffic Net. Traffic for Connecticut may be cleared by watching for Connecticut stations during the Nutmeg Net periods, 7:30-8:00 a.m., and 5:30-6:00 p.m. EST daily except Sundays. Conn. stations will be found between 3800-3900 on these schedules. W6LBE is lined up to handle traffic to Panama, Costa Rica and Peru. The Alabama A.A.R.S.' Phone Net is in high gear with the following members: W4RS/OH, Control, W4BMM, W4ZS, W4CDH, W4BSG, W4BG. The Tampa (Fla.) Amateur Radio Club will hold a 1.75-mc. phone QSO contest starting December 2d and ending December 16th; the object of the contest is to get every member of the club to equip his station with 1.75-mc. phone. 409 operators have submitted copies in the 1935 Navy Day receiving competition as this issue goes to press; complete results of the competition will appear in an early QST.

CENTRAL DIVISION

ILLINOIS—SCM, F. J. Hinds, W9WR—R.M.'s: 9AND, 9IHL, 9KJY. ENH is gradually getting things together for his new rig. MCC wants a "Q" antenna. BPU announces arrival of 7-lb. YL op—Congrats, OM. GSB wants the S.C.M. to join his A.A.R.S. net. Receiver completed, KXD begins on transmitter. KXE is still working nights. With all his schedules and A.A.R.S. organization work, DOU sees very little of his YL. IYA is all set for O.R.S. party. Things kinda dead for ERU. EQX is awaiting DX. VBT is JVJ's brother's call. AND is taking tap dancing lessons to go on stage with that beauty contest winner from Marion, Ind.!! Photography interests EGG. ITA is working 7 and 3.5 mc. SUW's '19 puts out a neat 56-mc. sig. HPG is head-over-heels in work. New Class A ticket adorns shack of SKF. VCB finds he can't work DX if he can't hear it. NGG controls net 2c Ill. AIU is operating on 7005 kc. RAQ is keeping nice schedules. Lots of Owl boilings at Egyptian Radio Club. TLD is interested in O.R.S. Keeping pace, with RWS, DBO says his call stands for "Dang Bum OP." Who wins? Have every one of you reading this sent in your stamped, self-addressed envelope to our QSL-manager, JO? You may be missing something if you haven't. Traffic picking up at DDO'S. Our best wishes for complete recovery to KA. ONR is building 1.75-mc. phone. New wind-generator plant for 32 volts now at ACU. VIP reports himself on 1.75-mc. phone. KHD's traffic report is full of goose-eggs. Four hams and six neighbors helped CUH put up his new 80-foot tower! RWS has his eye on an RK-28. Who hasn't? TCB is new member of A.A.R.S. Winter seems to stimulate activity at TCO, a common phenomena. INY likes "Hill-Noise." NMZ is building new superhet. WC is preparing for big winter season. AA's new control position is paradise for the lazy man, but a big improvement in operating ease, too. SSC wants to handle a pile of traffic. Don't forget your next report. LOH at Fort Sheridan is on 56 mc. and would like to hear from hams interested in QSO-ing with him.

Traffic: W9DOU 201 (WLT 35) DDE 190 CGV 157 (WLTG 4) RAQ 118 GSB 72 DBO 51 HPG 42 NXG 33 DDO 31 DJG 30 NGG 28 KJY 25 MCC-TBZ 13 KEH 12 ENH-FTX-ILH-LOL 3 SSC-VCB 5 CUH-BQH 4 TCO 3 ION 2 NHP-MRQ 1.

INDIANA—SCM, Arthur L. Braun, W9TE—HUO

leads the state in traffic this month. QG is making good use of new oscilloscope. ODH says QRN is ruining schedules. HUF has new Skyrider SX9. DHJ is ready for schedules and DX. AXH is remodeling his "Studio." SNQ has new Sky-rider. TZD has new All-Star super. FQ is QRL with A.A.R.S. schedules. JRK is back from Marion. HPQ has finished new rig and has new receiver. TGC is trying grid mod. 'phone. HUV won't give up DX until he gets Asia. TBM is under way with heavy traffic again. SPB raised F8, W6, X and D4 for DX on 28 mc. GFS is QRL school. EDP is pounding brass after several years on 'phone. NTP raised his first W6 on 'phone. NBZ likes 3.9-mc. 'phone best. JST is back at Terre Haute. HSF is at Kokomo now. UIX is QRL school work. DET visited JCG and is rebuilding. UYP finally went crystal. NNX is now working at Marion. TYF is ready for heavy traffic. URX moved to new QRA. SIQ's YL keeps him QRL. LQE is getting out fine on 1.75 mc. EGQ is getting bugs out of new super. PBS worked ZL for DZ this month. LYK is now W.A.C. after getting ZS. HBK is back at O.R.S. work again. PIL is ready for O.R.S. ISZ is settling down to radio after getting married. MQV is at Purdue in E.E. school. EWG wants O.R.S. SFG is getting out OK with new rig and has new receiver. EPT is QRL work. LCL wants new receiver. FOS is getting rig in shape again. STQ is now at Indianapolis and QRL N.C.R. work. UT gets out OK with new rig. LQ is DXing on 14 mc. EIJ likes 7-mc. DX. AUT works VK's on 3.5 mc. LWE wants O.R.S. All Indiana hams interested in joining up with U.S.N.R. write to 9TBE immediately for details. Men needed at Michigan City and all other cities. Those interested in A.A.R.S. write to 9HUO.

Traffic: W9HUO 215 QG 5 ODH 6 HUF 22 DHJ 15 AXH 2 FQ 13 JRK 6 HPQ 9 TGC 20 HUV 2 TBM 39 SPB 2 HSF 15 UIX 2 DET 1 HBK 2 TYF 17.

KENTUCKY—SCM, G. W. Mossbarger, W9AUH—Our 3810-kc. state net is beginning to function, and we are pleased to announce cooperation with the Ohio and Tennessee nets. Particular attention is called to the efforts of HBQ, EDQ, IFM, OMW, HAX and BAZ to keep the old state on the traffic map. SDC and RBV are doing good work at Purdue. ETT, EOM and SZK down Pineville way keep the mountains represented on all bands. CDA is having trouble getting final perking. BWJ posts "QRL business," but threatens activity soon. NGZ sports new Eimac. OX is once more among the living, with ARU putting in fifty-eighth transformer. BAZ finally buys ultimate receiver. HBQ is quitting job to handle Louisville traffic. TKP reports and handled few messages. Hurrah for TKP. KKG and MGT put JL on once more and the voice of U.K. is once more R9 on West Coast. JL is new O.R.S. and wants traffic for west coast. AYH is recuperating from auto accident along with IXN, who is once more exercising the tonsils on 3.9-mc. 'phone. DIX DAM threatens 1500-foot antenna for 1.75-mc. voice. JHY, Louisville's commuting ham, reports new HRO. ELL hauls off and matches same. BGA reports and works three stations to renew. JVA, SDG and TLZ fool everyone and report. HCD, HCO, AZY and FZV still sport licenses. FQJ is mad to the S.C.M. Gentlemen, there are still O.R.S. Contests. Let us get into one or two. 73.

Traffic: W9ELL 11 AUH 7 HBQ 85 TLZ 1 BAZ 27 EDQ 52 IFM 5 JVA 1 OMW 14 HAX 54 CDA 2.

MICHIGAN—SCM, Kenneth F. Conroy, W8DYH—Everything going up in the Michigan Section and the one-spot nets are taking the spotlight right now. The Lower Peninsular (W8) net is on 3656 kc. and the U.P. (W9) net will be on 3630 kc. The Chief Route Mgr., SDVC, will work with Assistant S.C.M. 9PDE and R.M. 9RHM to connect the two nets. See *D.A.R.A. Bulletin* for more dope. This is your chance to make history with Michigan—get yourself a crystal to work on that frequency and get going with the gang! MICHIGAN NINES: Assistant S.C.M., Joe Lessard, 9PDE, Box 223, Munising. CE will have that new crystal rig on the air as soon as he hooks the African for a W.A.C. with TNT '10 outfit. VJJ is new at Negaunee. ADY comes to life again. RHM had to drop his O.B.S. because of other ham business keeping him QRL. RIT reports EQV stopped crystal grinding to dig spuds! That's a lotta fun especially if the spuds are buried in chicken gravy! EXT visited the Detroit gang and the hamfest. BWU is still at Lansing

working for State. CEX complains of too much 1-kw. QRM on all bands—and double check! CWR wants to know where all the U.P. gang is hiding out! TTY Bros. finally hooked W6 on 3.5 mc. with 10 watts input! HSQ is still scratching at the bugs in his rig! DQT is putting out FB signal nowadays. MICHIGAN EIGHTS—ONESPOT—3656 kc.: 8DVC, Chief R.M. of Michigan, has the plan for the state-wide net all figured out and requests you to write him direct for schedules and information. We can get crystals for about one dollar or grind your own, O.M. MBP is lining up his schedules for the season. FB. Mrs. DYH now has Patsy calling CQ "Tarzan-fashion"! FWG is still plunking on 7 mc. NPC's first month in traffic and he likes it. MOF reports some activity starting on 56 mc. in Mt. Clemens. NZO is letting 56 meggies ride until warm WX again. ECT's new QRA: 50 Close St., Pontiac, OJT on 1.75 mc. will QSP or deliver all traffic coming his way. DWB/WLTF on State A.A.R.S. net daily from 6 to 6:30 p.m. will listen for traffic calls, when clear with A.A.R.S. traffic. CSX and AOM have totalled over 141 QSO's on their weekly schedule. Nice. NQ continues to be our most active Official Observer. KSY, AKN, NXT, FTW, FEE, LAV, DEN, EFI and rest of the gang are trying to recuperate after putting over that FB Hamfest. Much thanks goes to Tom Lombardo, AKN's new brother-in-law for the FB eats. A mighty fine job, Tom. We'll make a ham outa you yet! JPV at new QRA finds old B.C.L. skywire works much better than the old QRA'S carefully cut antennal SH gang reports six ops. at the M.S.C. with club meetings bi-weekly. NQI knocks off nice 3.5-mc. DX with antenna 15 feet above ground. LTH rebuilds and uses all new parts so he doesn't have to be off the air. NLV uses P.P. '01A's. OPT reports old DCQ joined the married men ranks. Congrats, OM. DPE finds the C.C.C. is all set and starting to perk FB, so Hal is just gonna sit down and boost the old traffic total. FRH is now in the U. S. Navy. CLL is building Tri-tet RK-20 outfit for home soon as he gets off the Lakes. MCA has new rig and new QRA. NKK would like a schedule with LSF if Bob didn't get up so danged early! FWU finally got the old thing going and can be heard pounding it out. CU took the big leap on Nov. 2nd. Congrats, RED—he says don't look for him until 1936!—after that he won't be worth looking for . . . LSF had a good time at the hamfest—says it's great to tickle a bug again. JKO sends in nice total and will be going up from now on. KMH tried 1000 volts on a '45—he is a student of *Aeronautical Engineering*. Hi. CPG will be one of the C.C.C. net stations. NUL keeps nice schedules—has 3.5-mc. zepp. CJZ pops up again—now in Quincy—howdy, Walt. FEE is working on a 1.75-mc. net. FTW missed the hamfest and did he miss something! Ask the gang! NXT, the dentist, is still looking for traffic. MGQ, at U. of M., found five hams in his Chemistry class! OAF is out in the sticks and dreams of a wind-driven generator for power supply. BRS says, "Don't cut my ears off, I'll get going yet." ABH is getting set for the Michigan one-spot net. AAH is back after seven years. AF has pair of RK-20's in P.P.—wants to know where FGW disappeared to. BQG has the '52 perking on 3874 kc. OCQ hooked PY and VO with '45. LTT is getting in line for O.R.S. appointment. DZ is looking for E type laminations—wants to make a jig saw. CTD's new QRA: 162 Cicotte, Ecorse KLR had to choose between studying for two exams or the hamfest—he enjoyed the hamfest! FAV has new '03A with 1600 volts and is all set for high-speed brass pounding. OEL blew his filter so borrowed IGL's—thereby, also, reducing local QRM. FOV had nice time at the hamfest. IOM is at new QRA: 238 Kitchener, Detroit, and on 3525 kc., red hot for traffic. Congrats, Dr. MI—Papa to a Jr. opr. Oct. 7, 1935! KAA thinks he oughta have more experience before trying traffic. JUQ, Allegan, is giving code practice on 56 mc. QH is on 56 mc. looking for DX. Lates: 9GJX reports 9UTY recuperating from recent operation. 9SQB/9PCU flower-growing contest will be announced in issue of *D.A.R.A. Bulletin*—copies free to all stations reporting. 73 and see you on the one-spot net, 3656 kc. SICM is gonna get hooked in spring—8FTW soon.

Traffic: W8DVC 505 GUC 313 DWB 290 ICM 143 LSF 109 JKO 74 JTK 34 LTT 25 DPE 19 NZO 11 NQI 10 NPC 9 OEL-OJT 7 MOF 5 ABH-BRS 4 OGV 4 FAV-LRC-NNE 3 CJZ-FEE-MBP-ODT 2 FTV-JYS-NLV-NUL-NVP 1.

W9RHM 223 PDE 29 GJX-TTY 12 PCU 11 CEX-HSQ 3 ADY 2 CWR 1.

OHIO—SCM, Robert P. Irvine, W8C10—IAW is working on Trunk Line "L." KUY handled traffic during fair at Shelby. MQO now has RK-20 in the final. KYI is new reporter from Oberlin. WE is going strong. MXH will have 70-ft. mast soon. LCY is working overtime but finds time for traffic. NGZ's antenna blew down. ISK rebuilt transmitter four times during past month. LZK reports by radio. DVL is QRL work. HCS is still trying to get going. UW visited in Toledo. NAL has nickname of "General." INT is trying hard to get gang organized. APC as usual reports by bulletin. MQC was visited by HMM and the gang. MUR and KEV are new O.R.S. AQ thinks he might rebuild. PKW is having trouble getting antenna to work on 3.5 mc. 9TAW is working portable at Lakewood, Ohio, after six years' absence. 8BMK is QRL college. LQM is new reporter from Columbus. FGC worked British warship, VP90, at Bermuda. LWB is installing crystal-controlled transmitter. ODB is trying for DX. LAU reports JOU busy with work. RN is still pounding brass at KFNN. JFZ is QRL University of Cincinnati. KLN is QRL Ohio State University. FNX has been out of town for a week. MMH is using 59's suppressor grid modulated on 1.75-mc. 'phone. NHO is QRL school. NHJ is having trouble with rig. NYY is trying 1.75-mc. c.w. LWP has new crystal. KAY is planning 3.9-mc. 'phone for winter months. KLP is still trying to get on the air. MRU has new crystal-controlled rig on 7 mc. KYQ will be back on the air soon. DQM and KVF are on 3.9-mc. 'phone. BKD and MRY have gone back to college. BRQ is operating from YX, University of Cincinnati. The newly formed Ohio net, "The Ohio Regulars," under the leadership of IAW and HMM, has had roll call, and a glance at the totals for this month will give you some idea of the good work being done. IS YOUR CALL AMONG THEM? If you want to hear a fine bunch of fellows working together, just tune that receiver to 3710 kc. any evening at 6:30 p.m. and get an earful, and if you don't become interested and want to join them, I miss my guess. The O.P.S. swung into action Oct. 20th and had a very fine round table QSO. Among those present were: HC, DXB, BYF, EMV, KNF, MMN, JTI, ODI, OGG and CIO. Homer (DXB) and "Doc" Weaver (BYF) have taken hold of the O.P.S. situation and are surely going places. HC opened the QSO with a nice talk and as usual when it came time for CIO to say something, he had nothing to say. With this report there are several new O.R.S. and O.P.S. appointments being made and, the way it looks, more will be made before next reporting day. 3DIY has moved to Louisville, Ohio, and will put a 14-mc. 'phone on the air; he is ex-NUBDB of 1925-26 at Warren, Ohio. KWN is still trying to join the Coast Guard as RM. IWL is on 3.9-mc. 'phone with a 5T. NQX is putting in a 211 on 1.75-mc. 'phone. MQA recently bought an SW3—almost new! HDG is fiddling around with motor-cycles now. LAE received a scholarship to Ohio State. CGK is putting up a new transmitting antenna. VP has a nice new rig built up. MZP says he will get on—eventually. CXC is still rattlin' off the DX. CBC visited KVX for the first time. NBM hides in the corner when his father brings him the light bill. KVX is putting in a '52 with a new Comet Pro—he hopes.

Traffic: W8IAW 241 KUY 108 MQO 99 KYI 83 WE 84 MXH 62 LCY 61 NGZ 60 ISK 54 CIO 51 (WLHC 86) LZK-DVL 43 HCS 40 UW 39 KIM 33 NAL-INT 26 DWT 24 APC 23 MQC 22 MUR 15 AQ 12 ITR-KEV 11 FKW 7 JTI 4 BYF 6 ENV-BMK 2 LQM 1 CMI (WLHI 18) W9TAW 3.

WISCONSIN—Acting SCM, E. A. Cary, W9ATO—Traffic is picking up and the boys are getting a few schedules once more. RSR requests O.R.S. application. AKT is building high voltage transformer for an '03A. EEEQ was recently married and thinks being a benedict is FB. RKP is working DX on 28 mc. IQW is working 5 nights a week as well as days. UTH worked both coasts on 7 watts. HSK traffic jumps but no schedules reported. BCF requests dope on the Kilocycle Club blow-out. SES is all set for winter; he has three schedules working. OXP will be on the air soon and ready for Trunk Line "A." LFK is trying to get some excitation into his final. RSA has plenty of soup in his antenna but can't get out. ATO is putting 802's in the final. James

Gundry, 8KNP/KTF, has moved from Pontiac, Mich., to Milwaukee, and is looking for a "9" call and O.R.S. The Four Lakes Radio Club of Madison sponsored 9AKT for S.C.M. AKT publishes a nice sheet for them called *F.L.A.R.C. News*. Let's hear about more of these sheets. ACK sends the following dope on the Sheboygan gang: CDC will soon be on 3.9-mc. 'phone with an '04A. SCR is back on 3.5-mc. C.W. AUX and HVB are still sailing the lakes as Ops. HSU is on 1.75-mc. 'phone. IDG is building to crystal rig. RZZ will soon be on high power Class A modulated 'phone. CXX is busy carrying mail for Uncle Sam. BTA will soon be heard on 1.75-mc. 'phone. ACK was heard QSA4 R5 in Moscow, Russia, on 7 mc. and two places in Germany on 3.5-mc. QSA5 R 5-6 T9 with an '04A in final. Three nominations for S.C.M. election to be held in Wis.. 9AKT, 9BVR and 9ATO. Should be a hotly contested election. May the best man win! LOH, after seeing the country, settled down in Fort Sheridan, Ill., working with the Signal Corps. RH sends the following dope on Milwaukee activities: The Milwaukee Radio Amateurs Club, Inc., had its second "Club Meeting Broadcast," over W9XAZ on 31600 kc., Nov. 14th, at 8 p.m. Central Time. 9NY spoke on 28 mc. in the past year. The Milwaukee Club gang is getting more active on 28 mc. every day. NY worked 5 continents Saturday, Oct. 19th, and 4 on Sunday, Oct. 20th. GHN seems to be trailing very close to NY with new countries being added every week. GEN worked VK's on 28, 14 and 7 mc., all within four days. RH and RKP had their first contacts on 28 mc. LJU has his receiver perking on 28 mc. and is getting transmitter going. DTK gave nice talk at club meeting about M.R.A.C. and A.R.R.L. history dating way back to 1912. NPS is building up a new '52 rig for 7 and 14 mc. GIL has been forced to take down his super antenna that was up on top of an 8-story factory to satisfy the Insurance Co. DII hopes to turn on the power about Dec. 1st, 800-watts on C.W. IH, while oping on the S.S. *Fitzgerald* on the Great Lakes, reports that he's hearing 28-mc. sigs FB on his portable Q-5 receiver. HFA is moving upstate to Baraboo. EIH, LJU, DIJ, IZT and ENP are working at Wis. Bell Telephone Company in Milwaukee. UIT is back on 7 mc. for time being until 3.5 mc. gets better. New members of M.R.A.C.: VIB, UNY, KIZ, SZH, GKE, JGU, UOE and x-3KNP. GSP built new amplifier for his 1.75-mc. 'phone. DFF is back on 7 mc. with RK-20 and is busy with club doings. BVR is running for S.C.M. and was endorsed by the M.R.A.C. EIH, ASL, and BVB have left ham radio for the time being. CCD is thinking of reviving The Royal Order of the Derby. Members must wear a Derby at club meetings and keep it on during entire meeting, paying a fine of 5¢ if they forget. This fund is used for some entertainment for the gang later on in the season. Each member must also use green ink in his correspondence. ESF is again attending meetings. (He's the M.R.A.C.'s only Life Member.) ANA, the club's Technical Committee, is again giving talks from chapters of the A.R.R.L. Handbook.

Traffic: W9HSK 105 RSR 21 SES 14 RKP 13 AKT 7 UTH 2.

MIDWEST DIVISION

IOWA—SCM, Phil D. Boardman, W9LEZ/WLUD—R.M.'s: 9ABE, 9CWG, 9HCH, 9LCX. P.A.M.: 9AED. The bug has bitten again, and our reports on traffic and activity look swell. Looks like a big year for our Section. The Burlington Club station is looking for calls on 1.75-mc. 'phone with the call UNH. More reports by clubs would be appreciated. How about it, secretaries? LEZ handled 121 messages in one evening! NNM is now Iowa member of Trunk Line "G." HCH loaned crystals to members of his A.A.R.S. net. AWH is acting D.N.C.S.-A.A.R.S. CWG claims his note sounds like "pulling a cork out of a bottle." Hi, LCX increased power, and is lining up trunk line schedules. GWT says his '10's get out as well as the '52. ABE received R7 from LU1EP, and X1AY on 28 mc. PGG is active in A.A.R.S. IPC reports for Burlington gang. ACL says "new low in traffic." SRP has a new 45-foot mast. RUC is active on 56 mc. SQK hopes to be a radio engineer. SQO boasts a new antenna. CFZ will have new 1.75-mc. 'phone going soon. PAH will have station back on the air by Thanksgiving. SRK is making PAH happy by letting him

use his station. VBY is new ham in Burlington. TMY moved from Ft. Madison to Burlington. UNH is on 1.75-mc. 'phone. SQL got rig going and receiver quit. (Wotta life.) TKA moved to Iowa from Mo. REH is newcomer to Iowa A.A.R.S. net. DZW, Gramp, is swamped with printing business.

Traffic: W9LEZ 661 (WLUD 199) NNM 323 HCH 96 AWH 82 CWG 35 (WLUU 2) LCX 32 GWT 15 ABE 12 PGG 10 IPC 6 ACL 4 REH 15 DZW 30.

KANSAS—SCM, O. J. Spetter, W9FLG—R.M.'s: 9KG and 9RIZ. We have a new R.M.: RIZ of Agra will take up these duties from now on. PXW moved to West Plains, Mo. LXE has new Breting receiver. FMX is in jail house again (veterans hospital). IOL moved to Anthony. EFE, LTO and TKF are rebuilding. K.V.R.C. Convention was a great success and FLG had lots of visitors in shack. FRC won Wouff Hong trophy for 1935. Come on, fellows, jar loose with those reports.

Traffic: W9FLG 348 RIZ 334 KG 125 OZN 77 EYY 66 SJV 63 FMX 10 PB 6 SIL 2.

MISSOURI—SCM, J. Dewey Mills, W9CJR—AIJ leads the Section in traffic with SGP running second. OQI is holding several A.A.R.S. schedules. HUG is hitting on high with D.N.C.S. job in A.A.R.S. KCG handles his traffic with '71A final at 5 watts input from "B" batteries! YL OUD asks for O.R.S.—Atta girl! KEI accepts Missouri position on Trunk Line "E." EDK (Ex 5EIP) gets O.R.S. UYF requests O.P.S.—Any more want 'em? DHN is still after the elusive DX—wants Asia to get W.A.C.—took message from 6EAR addressed to 9FEA and made direct delivery within 8 hours! VEE is revamping to work 3.5 mc. and traffic. JAP has been away from rig all summer but now back and ready and rearin' to go. St. Louis gang says: Amateur Radio Association is still going strong; monthly meetings with over 150 members—Amateur Radio Fraternity, South St. Louis Hams, will hold field day this fall with battery rig. GTK is back on 3.5 mc. after sojourn on 7 mc. CCZ is off the sick list and on the air again. LTH is rebuilding for 3.5-mc. c.w. KIK deserted 3.5 mc. after 3 years to land on 7 mc. UAB is ironing out troubles in generator on wind power rig. NOL reports from New Cumberland, Pa., this time. GBJ renews O.R.S. and reports efforts for DX on 14 and 28 mc. The S.C.M. wonders why not more individual reports from those St. Louis hams. What say, gang?? Who wants P.A.M. appointment? Let's have MISSOURI REPORTS—MORE MISSOURI REPORTS.

Traffic: W9AJJ 701 SGP 179 TGN 166 OQI 77 HUG 67 ENF 30 KCG 17 OUD 15 KEI 13 EDK 9 KEF 6 DHN 2 VEE 1 (Aug.-Sept. NNZ 83).

NEBRASKA—SCM, Samuel C. Wallace, W9FAM—BNT leads the Section with FB total. FAM is back in the A.A.R.S. as S.N.C.S. and traffic totals greatly improved; he is working on Trunk Line "L." DMY is doing nice work, handling various schedules. RUJ is keeping few nice schedules and helping keep the ole state alive. EHW is pounding away on the A.A.R.S. in fine shape. POB just lined up in the A.A.R.S.; he says Trunk Line "E" to W7DIE is working. DI has moved to St. Louis, Mo., and will be active there in the future. Sorry to lose such a good man! KQX is keeping nice bunch of schedules. KJP expects to do a little more traffic work in the interest of Omaha this season. TBD has been doing a little DX work but is looking for traffic and some good schedules on 3.5 mc. DGL had an FB trip to the northwest coast and southwest and reports visiting a lot of hams on his route. DHA is operating in U.S.N.R. at Grand Island. THF, BQR, JEE, and KVB report.

Traffic: W9BNT 2110 (WLU 217) FAM 365 DMY 105 RUJ 66 EHW 65 POB 23 DI 17 KQX 10 BQR 7 KJP 6 TBD 5 DGL 3 DHA 15 THF 16 JEE 33 KVB 45.

DAKOTA DIVISION

NORTH DAKOTA—SCM, Hartwell B. Burner, W9OEL —UJC has moved to Billings. SWC is at New England C.C.C. pinch-hitting for AZV, who broke his ankle in football game. KZL has new Sky rider with metal tubes for C.C.C. station. RYZ went to Dunsieith to set up C.C.C. station. DGS visited AZV in hospital. RQZ at Hope received emergency station certificate. HJC attended the Minnesota and Tulane game. DGS taking over Jim's duties

in A.A.R.S. while gone. PVA visited with HJC in Fargo. PHH is back home after Red Owling at Grafton. DGS reports new rig: 6F6 osc., 802 buffer, 801 final. North Dakota Section inaugurates North Dakota Bulletin via JZJ on 3971-ke. 'phone at 12.30 p.m. every Sunday. Bulletin meets with instant success with practically all hams here tuned in. You North Dakota ops are urged to send all material for this bulletin to JZJ at Leeds. Appointees are asked to send traffic and other reports by Form 1 instead of via radio. Very pleased with traffic reports this month, but hope we can double these totals next month. What say, gang, let's keep this Section on top.

Traffic: W9EJC 511 OEL 227 DGS 218 KZL 273 PVA 72 PRU 31 SWC 29 STT 26 STJ 19 DYA 18 RQX 12 BMR 10 JZJ 9 SGN 8 PHH-IBQ 4.

SOUTHERN MINNESOTA—SCM, Francis C. Kramer, W9DEI—BKK is looking for new members for the A.A.R.S. TQG plans on more 7-mc. operating this fall. IJN is interested in O.P.S. appointment. KDI says, "To an old-timer like me, gals don't mean nothin'." AIR has one more month of commercial oping before he will be back at ham radio. RKG has little time for radio now that he is in college. BTW now has 70 countries, and reports working G2BY on 7 mc. ELA had 51 European QSO's in five days. MXW has his rig on 28 mc. IXI gets good reports with his '03A 'phone job. OMI is op at Rochester C.C.C. camp. PJA gets more of a thrill from receiving than transmitting. GTE divides his time between YL's, a car?, and radio. FMA hopes to return to Mpls. soon. HCC is thinking of putting in a small 'phone. IFHE is now living in Wayzata, and expects to be on soon. OGU and BXC spend most of their time on 3.9-mc. 'phone. DEI is still working on the 1-kw. rig. With the fall season upon us, let's all get a couple of good schedules lined up. Don't forget, PDL and BKK will be glad to arrange schedules for you.

Traffic: W9BKK 82 TQG 15 BN 14 DEI 8.

WEST GULF DIVISION

NORTHERN TEXAS—SCM, Richard M. Cobb, W5BII—DNE and the Sherman gang put over the ham exhibit at the fair in a large way, making the B.P.L. EEW also makes the B.P.L. this month; he reports that WLMF is back on the air. Dallas was visited by Brad of WLM and 5BML. AZB sends nice traffic report from Abilene. DXA reports AXK has moved to Bryan; BEY has '48's in final amp; AVC is active; CIN is active on 'phone. BII added a final amp. to the rig using a pair of '10's in parallel and is active in Trunk Line "D" on spot frequency of 3865 kcs. ARS is on Police Radio job. COK is now an Official Observer and has increased power. CPB and CPT are running the new show in Clarendon. FBQ is interested in an O.R.S. appointment and is working DX with flea power on 7 mc. EHM wants to hear from stations copying the Official Broadcasts from his station. IA reports his crystal freq. won't stay put. APW is rebuilding and will be back on 3.9-mc. 'phone soon; he is active as O.O. with an e.c. freq. meter. QU has now Worked All Continents. FEA is on the air using two 43's in P.P.; he was NU5AWW about 8 years ago. FFX is rebuilding crystal rig using a type '10 final and will be active in the A.A.R.S. soon. FCU is about to get a 1.75-mc. 'phone rig ready to go. EGN will also be using 1.75-mc. 'phone soon. EFN moved his station to Lubbock where he is attending Texas Tech. VD reports NH is really stepping out on 14 mc. with an RK-20. 5AHC was killed in an auto accident near Fort Worth; he had been well known in ham radio since the days of spark.

Traffic: W5DNE 507 EEW 501 AZB 325 DXA 205 BII 152 ARS 73 COK 25 CPB 14 FBQ 9 EHM 6 IA 2.

OKLAHOMA—SCM, Carter L. Simpson, W5CEZ—CEZ worked a ZL on 3.5 mc. AMT reports Trunk "D" operating FB. BJG has his A.A.R.S. district working efficiently. ASF has forsaken C.W. and gone 'phone exclusively. DDW is installing a pair of 830's in final to go with his new Skyriders. EXZ wants more traffic. BWN moved to new QRA and resigned as Okla. 1st District D.N.C.S., A.A.R.S. ABK and AMS spent an enjoyable vacation in Calif. DQM is always on the job for A.A.R.S. drills. BTZ does all his work on 'phone. EST and EIH are new members of the

Oklahoma A.A.R.S. 'Phone Net. BLJ has a new ACR-136 receiver. BDX is still working on his super. CVA is trying to get his rig to perk on 3.5 mc. FDU attended the Kansas State Convention in Topeka and has his new rig perking. FX moved from 7 to 3.5 mc. and signed up with the A.A.R.S. CSU has been assigned the duties of D.N.C.S. for the Okla. 1st District in the A.A.R.S. BKK, due to his school and extra curricular duties, resigns as D.N.C.S. for the Okla. 2nd District and his place is taken by DZU. AVB moved to Monett, Mo., where he is teaching in the high schools and expects to be on with the call 9JUK. BOE is on the air with an RK-20 and gets back into the A.A.R.S. FFK has completed his new rig and is looking for traffic. DQV has been working some nice DX on 14 mc. c.w. CEQ moved his shack to his garage. KZ is sporting a new PR-16 and a pair of 801's in the rig. EMD has acquired an 825 and is installing it in his rig. AIR is very much put out over the promiscuous use of c.w. in some of the 'phone bands. AFX and QL work some nice DX on 28 mc. ARB installed a Johnson Q antenna.

Traffic: W5CEZ 1206 AMT 426 BJG 229 ASF 127 DDW 78 EXZ 62 BWN 54 ABK 42 DQM 28 BTZ 22 EST 20 EIH 20 BLJ 16 BDX-CVA 13 FDU 5 FX 4.

SOUTHERN TEXAS—SCM, Bradford A. Beard, W5ADZ—Luther C. Smith, W5EEO, writes the activity report this month as ADZ gets the coveted brass-pounding job with RMCA on S.S. Pueblo, KESV. FD says DX is picking up. BWM complains only one "beep" out of PF recently. JC is back on 14.2-mc. 'phone with 4-52's. EIS is hot on 7 mc. DBN sports crystal. SF, EDX, and DCP are on 14.2-mc. 'phone. EUL is an "ole-timer" who couldn't resist the urge to give it another fling. CXJ sticks to 56-mc. experimentation. BEF is good traffic handler. OW, two-operator station, keeps many daily schedules. BJ is getting on spot frequency with A.A.R.S. CTW uses kw. into '52's. FBD is getting on 1.8-mc. 'phone. EQK and ARC are QRL U. of Texas. EVH has had case of twin YL-itis!! DGG plans 3.9- and 14.2-mc. 'phone. DHJ experiments with "1.25 meters"—big DX so far is one block—Hi! VV returned to home, Austin. EUN uses '10's. EQW worked 450 miles with ½ watt. FEP is using 59 Tri-tet. ENR works 1.8-mc. 'phone and DX c.w. EPE, enroute to Oregon with mobile 56-mc. rig, asks for contacts. EPF, his brother, will remain in Wink, tryin' hard to make that '10 do its stuff. FGZ is QRL BC sets. DOB uses 212-D final. ETT is very active. MN has 105 schedules each week and clears enough traffic to look like news bureau. DLT is changing to '03A in 1.8-mc. 'phone final. DUK contemplates 1-kw. 14.2-mc. 'phone; he is using 200-watt 1.8-mc. 'phone at present. DFC is having license troubles—been four months since he took Class A. EKP is QRL school; he is rebuilding to '10's on 1.8-mc. 'phone. EOO is QRL school and P.A. work. CHB is trouble shooter for geophysical companies. PH, Tyler, is active on 1.8-mc. 'phone. EKN operates 7-mc. c.w. and is building 14.2-mc. 'phone. DWN is working on 2-28-mc. rigs, handling traffic and experimenting. PC turns in swell report for G.V.R.C. G.V.R.C. elected Board of Directors; CIX (Pres.); EUO (Vice Pres.-Treas.); BYB (Secy.); FBC; and PC. G.V.R.C. is to hold annual blow-out Dec. 18th. Many prizes promised, everybody invited. Address 5EUO for registration (\$1.00). CIX is working on 1.8-mc. 'phone and has 400 watt 7-mc. c.w. rig operating. ECB and DLO are rebuilding. BYB is QRL BC sets and P.A. business. EUO schedules ENR. EWI gets on daily for short time. FBC is increasing power. RA is QRL beer business but maintains WX and A.A.R.S. schedules. FFR threatens 1-kw. 'phone on 1.8 mc. PC is rebuilding to '03A final and plans to join G.V.R.C. 1.8-mc. 'phone net. FAH, on 1.8-mc. 'phone, is accused of being stranded hermit in the bush! Sally and Millard, the Walkers of Wharton, are putting the finishing touches on BVK-AHK 1-kw. 14.2-mc. 'phone. BUB is doing nice work with small equipment on 14-, 7-, and 3.5-mc. c.w.

Traffic: W5MN 1098 OW 671 DWN 84 BEF 52 EUO 14 FD 13 EKN 10 BJ 8 BWM 2.

NEW MEXICO—SCM, Joseph M. Eldodt, W5CGJ—This report prepared by A. P. Sitton, Jr., W5DLG. CGJ (S.C.M.) is on vacation taking in the activity of the A.A.R.S. HDQ station at Fort Sam Houston, Texas, (WLJ-50W) ZM has new HRO and expects to have 1.75-mc. 'phone rig going before long. ZM is kept busy with A.A.R.S.L. Trunk

line and A.A.R.S. traffic. DZY is working portable at Gallup and will soon be located in Ariz. We all certainly hate to lose such an active amateur from our Section. DLG is doing double time, working in Post Office and Picture show, and is only on for short times in the mornings before 6:30 and now and then in the evening.

Traffic: W5ZM 87 (WLJG 83) W5DZY 25 (portable 30) W5DLG 44.

ATLANTIC DIVISION

EASTERN PENNSYLVANIA—SCM, James M. Bruning, W3EZ—R. M.'s: 3AKB, 3AQN, 3EOP, 8ASW. High power does not make a good operator, but regular practice does. O.R.S. and O.P.S. are the highest skilled operators in the country. Are YOU in that class? If not, why not? Brasspounders this month: 3EOP and 3EZ. AQN divides time between radio and the new baby. AZJ was heard in England with 40 watts input on 3.5 mc. BES and EUP are working for O.R.S. rating. BXE has new Jr. Op., born Oct. 6th.

WESTERN PENNSYLVANIA—SCM, C. H. Grosarth, W8CUG—GUY changed his QRA and doesn't have the new skywire up yet. GLA is recovering from a siege of pneumonia. OJP sends his first report and has a nice rig working on 7 mc. FIP has been off the air rebuilding. UR burned up his class B output transformer. KWA busted a nice new '52 using 800 watts! GUF now has ten schedules working and promises some of those big totals again. EFA joins the O.R.S. gang and starts off with a swell total. KBM becomes an O.R.S. and says they had a nice hamfest at St. Mary's. KNB wants to know why we can't have a single frequency Penna. net. FPE has been appointed an O.O. and wants to join the O.R.S. LOQ is busy with school, work and schedules. INE returns to the air after the summer vacation and says NDE and KXP are on 7 mc. UK is busy with the A.A.R.S. again. LWK comes to life and reports again; he operates the C.C.C. station at Wellsboro. KOB says he is going to pound more brass now that it's getting too cold to fly. NNC promises a bigger total next time. IOH puts his broadcasts on 3660 kc. Mondays and Fridays at 6:10 p.m. MOT is getting ready to put some juice into the '03A's. IUY expects to be busy with N.C.R. activities this winter. IQB keeps a schedule with PY1AW on 14 mc. LIG says the Warren Amateur Radio Ass'n expects to become affiliated soon. OFO traded his Eimac 50-T for an '03A. CQA has been busy installing auto radios. CMP attended the Roanoke Convention and has been struggling with metal tubes. RG is looking forward to the next O.P.S. party. KQQ got an R9 from CX2AK on 14-mc. 'phone. CUG can be heard quite frequently on 3620 or 3515 kc. again. MHE sends the usual line of chatter from up the Valley. JCE we think is going to be hitched. IZD has a new Skyriver receiver. OLM has turned to 1.75-mc. 'phone. OLA wants to get an M.O.P.A. rig. MHO can't seem to work out of the U.S.A. MJF is planning a new c.c. rig. LBP works 3.9-mc. 'phone now. ASV spends his time looking for DX on 7 mc. DYV got the new 400-watt rig perking. HDY will soon be with us again. KBC and KBQ had CRJ for a visitor. NTM is rebuilding the rig. NRB gets out on 3.5 mc. quiet well. GVI works 3.9-mc. 'phone. BKH can't be coaxed away from 14 mc. EVE will have a pair of '52's on soon. GUX has a new Skyriver receiver and we think MST will get a lot of use out of it. MSV is waiting for a new crystal. CRJ and BTQ attended the Alle-Kiski Radio Club meeting. GRY visited the gang in Natrona.

Traffic: W8KWA 411 GUF 299 EFA 185 KBM 161 KNB 116 FPE 104 LOQ 51 INE 33 UK 26 LWK 22 KOB 21 NNC 20 IOH 15 MOT-IUY 14 IQB 12 LIG 10 OFO 8 DGL 7 CQA 4.

CANADA

MARITIME DIVISION

MARITIME—SCM, A. M. Crowell, VE1DQ—Nova Scotia: IGL is new R.M. and control station for N.S. in Maritime Net; he is also building Class B 'phone. EA schedules VE2BT semi-weekly mostly on 14 and 7 mc.; he worked CE, FE and IW on 28 mc. and handled traffic with VE5NO, Ontario Island. GD says Collins network is FB. CE schedules his brother, IV; uses SW3 receiver, two

separate transmitters, 14- and 7-mc. crystal. CD uses P.P. par. '45's and SW3. IW is new station at Newport Landing. He uses P.P. RK-20's final crystal-controlled and home-made s.s. with crystal and a.v.c.; he works 3.5, 7, 14 and 28 mc. GF has moved to Montreal. FE's crystal controlled 14-mc. 'phone has been heard in Bombay, India. IX, new station at Mount Denson is using '45's P.P. on 3.5 mc. IU is new man coming on at Hantsport with P.P. '45's. CV, Summerville, works 3.5 and 7 mc. EX landed the W.A.C. by working VK. BM will soon hit the air at Summerville. BW is very QRL work, HN will soon have the 1.75-mc. 'phone going. DN is taking a shot at DX. BU is going on 1.75-mc. 'phone this fall. GK is on the 3.5-mc. band. BV expects to be hitting the air from new QRA, Truro. BT uses prize mike won at hamfest. AW is Phone Activities Manager and O.B.S. on 3.8 mc. EL moved from Moncton to Truro. DW is getting the 1.75-mc. 'phone ready. AM works 3.9- and 14-mc. 'phone. BO, AO, AJ and DG are working in new Can. 'phone band, 3850 kc. GJ is technician on staff of CFNB and works 3.5-mc. c.w. HS is Morse opr. at McAdam and uses 3.5-mc. c.w. FJ works 7 mc. exclusively. GU's new rig uses pair of '10's in Hartley. CJ has P.P. '45's TNT. FC is on 3.5 mc. three nights a week. EQ accepts traffic any time; he has the 1.75-mc. 'phone going FB and is going to try the 3.9-mc. band. EP is still piling up the DX on 14 mc.; 70 countries to date. DQ is going to put the 14-mc. 'phone to work again via new Johnson "Q" antenna. GI, Loch Lomond, uses 59- '46- '10's and got report from Tjikistan, in addition to over 50 foreign QSO's. GS is another old Morse man for C.N.R. at Moncton. Prince Edward Island: HH is Net Control Station for P.E.I. and schedules GL and EQ daily. GS is on Sundays for usual hour rag-chew. BZ is on with new rig: 2A5 '10- '10's final. IV just got back on after month's illness. He schedules his brother, CE, in Windsor. FT has new rig going great. HX is building new RK-20 Tri-tet. DB is planning a new rig. IA is QRL on farm. BL is getting out FB on 7 mc. with Single '45. EY is QRL service. The H.A.R.C. Maritime net with VE1GL, Route Manager and Chief Control Station is now functioning perfectly. About ninety percent of the dope contained in this report was landed direct in Halifax via the quickest and most logical method—our way—amateur radio. If your call is not in our report this month—coöperate next month by working a control station and sending in the dope. Newfoundland: The Second Annual Convention of VO hams was held Nov. 11th. VO1W reports for VO gang. Active on 'phone: VO1H, VO1I, VO1I/P, VO4Y. VO1L is on 3.5 mc. VO1P is rebuilding. VO1Z/P is working VE1's with a 5-watt 'phone job. VO1T changed QRA. VO1H is getting married.

Traffic: VE1GL 52 EA 18 GD 10 CE 3 IX 2 HH 8 VO1W 4.

ONTARIO DIVISION

ONTARIO—Acting SCM, F. W. Hartley, VE3JT—The very best wishes of the Ontario hams go to our S.C.M., VE3GT, and his bride, who are honeymooning at the time of writing. He was presented with a new buz, as an added incentive to keep the station in operation. JT helped him move station. GT is running for Canadian General Manager. SG, QK and HP are candidates for post of S.C.M. GW applied for O.R.S. GG keeps traffic on Trunk Line "I" moving. JT has new rack-and-panel transmitter. RK and QH have new supers. QD and AEM are on 14 and 56 mc. respectively. New equipment at AFJ, OJ and HA. QRO at VJ. QM has his own radio room in new house—lucky boy! QV had fire in rig. TG blew tube. ADF was a farmer all summer. QE modulates 802 buffer. Come on you hams in the Ambitious City of Hamilton, get busy and handle some traffic! Try it. It's lots of fun if you go about it in the right way! MX reports QRL work, and local club has new shack. QN has new "accordion" rig—push-pull—Hi! ER sends fine traffic total from new QRA in Oshawa. SZ says local hams are tuning up for winter. XU steps out with new rack rig. ADD sends first report, and a nice one, too; he's using 100 watts crystal on 3800 kc. UX gets on the air when not filling teeth, using both 'phone and key. WK keeps good schedules. DJ boys will have a pair of RK-20's perking soon with both 'phone and key. TM is rebuilding and will soon be back on Trunk Line "M." GO is heard on 'phone sometimes. CG is applicant for O.R.S. AU is using 'phone on 3852 kc. You fellows

interested in traffic handling, PLEASE get in touch with JT, or your nearest R.M., giving full dope on your station, schedules kept, if any, time available for schedules, etc. We have been trying so hard to get a Provincial Net working, but it can only be done by everyone doing his part. Write right now! This applies to all stations handling traffic.

Traffic: VE3GG 58 JT 25 GW 11 SG 23 WK 68 QK 356 ZE 2 ADD 19 XU 3 ER 40 VZ 5 GO 216 CG 15 AU 7.

QUEBEC DIVISION

QUEBEC—SCM, Stan Comach, VE2EE—The approach of the fall season is evident from the activity on all the bands. The 3.5-mc. band especially shows that a lot of rigs have been dusted off and keys oiled. Traffic totals are again on the increase. BB is our new Trunk Line Station and schedules AP and JK for Montreal outlets. DR is the new R.M. and is doing good work. DG is the Trunk Line Alternate. EC is new O.R.S., traffic is nothing new to the Rev. HT complains of QRM. JZ is attending McGill. BU is still keeping that Toronto schedule, the old reliable. Another VE3 lines up with us; x3AD is now 2LC. Welcome, Bill. KK done gone an' got married. Congrats, Bud. JE has moved the location of the station; we pity JK, hi. FQ has a nice sounding 'phone on 14 mc. GU and GZ are going North with FQ. Good luck, fellows. GA has fallen heir to a new mike. CA has been trying his luck on 7 mc. and talks of keeping schedules with VK's. DQ is back with the gang after 15 months in England. GE says he heard an XU on 7 mc. BU is using a new receiver and likes it very much. DM is trying the Jones three-tube super. AM is modulating a pair of RK-20's. HM has a rig at his country home. IE is considering Class B ten's. DD is rebuilding and we believe that IQ is also. IY is the DX man in that territory. IDE, who was with us for a while, is now in Kingston and hopes to have a VE3 call soon. IO is coaching quite a few ladies; it must be his curly hair. CR has erected a 60-foot mast in the backyard, it took a complete rugby team to hoist it. HS is putting out a nice 'phone signal. Our deepest sympathy to W2HVI and his brother on the sudden passing of W7AOF (W7DHF). A true Ham has passed on. Traffic schedules are being arranged between strategic points of this Section as well as with outside stations, and when we accomplish the completion of our network communication channels will be available to every point of importance. The new R.M. is doing a good job and with the elimination of inactive O.R.S. the Section will be a live one.

Traffic: VE2GO 6 JK 32 BB 25 BU 44 DR 72 EC 15 BG 26.

VANALTA DIVISION

ALBERTA—SCM, J. Smalley, Jr., VE4GD—Winter brings its usual increase in activities and numerous new stations are to be heard on both 'phone and c.w. as well as numerous oldtimers who have reurrected. LX as usual has the highest total; he is back in Calgary for the winter leaving LA with the whole town of Rockyford to himself. SD has the Frontiersmen Network pretty well lined up. QK still does his bit in the traffic world and more than his bit in the realm of rag-chewing. WG at Thelma has put Alberta on the 1.75-mc. 'phone map. OD has joined the 3.9-mc. 'phone ranks. FG attended the Pacific Division Convention. EO's visit to Calgary resulted in his getting bitten by the 'phone bug. The Calgary gang is talking hamfest for next summer. JK is using all bands to advantage. KI is also active in Strathmore. HK has moved onto a farm. DA has gone north and AW and AR have come out for the summer. RV gets out FB with a low-power battery rig. SN is on 14- and 3.9-mc. 'phone using GD's rig. RQ has rebuilt crystal. OF and JW like the Jones exciter. BZ has been too busy to amass his usual great total. It is time to consider who is to be next S.C.M. Yours truly will be unable to handle the job again.

Traffic: VE4LX 112 SD 27 QK 26 BZ 14 JK 8 EO 2.

BRITISH COLUMBIA—Acting SCM, Don Vaughan-Smith, VE5EP—FM, EN and AM have gone super and RK-20. LQ is now with B.C. Police. NL is QRL mountain climbing. Commercial oping keeps JL and HP from their schedules. AN and KU (Bob) are now sporting better halves! FQ clicked with ZS2X and is now out for W.B.E. EU and EH made their W.A.C. with that African, too. KC is threat-

ening to go on 14 mc. 'phone. KA visions a 212 in the final. JK spends his spare time cussing a doublet feed. BK is now putting out a hefty sig, rivalling DS! GX in new QRA has plenty of trouble getting up ant. DV sold his rig and is now out for 56 mc. JZ is back with '45's on 3.5 mc. JL had first experience comm. OQ acquired DV's pole transformer. IC has plenty of grief with doublers on 14 mc. JC is busy pushing a football around. EC says larger print in call book nets more cards. FZ roams around with c.c. on 3.9-mc. 'phone. 5YL made a tour of the interior gang.

Traffic: VE5AL 3 KB 4 AC 25 NL 4 KV 2 ND 6 OK 54 DV 17 EP 33.

PRAIRIE DIVISION

MANITOBA—SCM, A. J. Simpson, VE4BG—All Trunk Lines are in full operation once again and set for the coming winter season. AG will handle all Trunk Line traffic east and west of Winnipeg with GC relieving in any emergencies. All rural stations in Manitoba wanting to arrange schedules as feeder stations to the Trunk Line are requested to get in touch with AG, who is Route Manager. TV is busy lining up his country schedules again. The 14-mc. band still very popular and there is still lots of DX to be worked. DU is to be heard working G's on 'phone these days. KX is all set in new QRA and busy getting up a vertical. GC is still working with 56 mc. MY has been having trouble with his modulator. RO lost one of his 250-watt tubes. NI is reported to be going high-power 'phone. KU is looking around for a bigger tube for his final. Winnipeg is going to lose another one of the gang. John Simons CD expects to leave shortly for up North, operating for one of the Airways. AP from Foxwarren is a visitor in Winnipeg and reports UV and himself as getting together with 200 watts c.w. VE5AC is in Winnipeg for a short time and expects to get around to seeing some of the local bunch. MV is still QRL business. AE is sticking to 7 mc. these days. DJ is waiting for conditions to settle down before coming on very much. DV is cleaning up rig and will be heard soon. ER has left Winnipeg for about a year. FT is going to duplicate his DX records of a season or two ago. IP is back again. LH is just about ready having finished making several changes. QA is consistently active on all bands. SS spends most of his time with 56 mc. and is making good progress. The 56-mc. band is about the most active around here now. The M.W.E.A. has reopened for the coming season and already many new prospective members are showing up.

Traffic: VE4AG 79.

SASKATCHEWAN—SCM, Wilfred Skaife, VE4EL—The Moose Jaw Club started away to a new season with new officials; JU in the chair is heard inside and outside the club room. SY worked OA, F8 and G since building new receiver. IG is back on the home station. PG is hunting DX on 7 mc. VG worked his first X. KA put up 55-foot stick. OP is heard in East in wee sma' hours. OM after antenna grief is on again with new 7-mc. crystal. KS is chasing bugs in B.C.L. sets. FW back from North is building RK-20 rig. JV worked 28 Europeans in a week. LV back from East gets going again. Saskatoon Club started away with new officers, PW in the chair. He and PQ are again trying 28 and 56 mc. UH has FB crystal rig in construction. QZ as QRM Comm. starts on his own sigs. PE is building c.c. rig. 3BY is now domiciled at Saskatoon. Welcome, OM. UD is putting P.P. '10's on 3.5 mc. MB back from wintering in L.A. reports swell time with the W6's. RB is either busting behind a joy stick. Congrats on first solo, Gord. RJ is training junior opr. on the mike. FD back on 14 mc. is warming up his groove in the band. BF, solo on 3.9-mc. 'phone, will soon have company. Your S.C.M. visited ES, OC and KJ and met BL, also visiting. OC displays very neatly built rack and panel housing two rigs. KJ with best transmitting site in Section makes nice contacts on 3.5 mc. with 1.5 watts input. XM's other '66 went West. EU is now 5Mq and still sends along news. He and GA and BZ attended Spokane Hamfest and had good time. The gun went off at the Regina Club, MK in the chair. Your S.C.M. sends best wishes for successful season to all three clubs and will watch your smoke. QQ receives DX cards on 14 mc. before he explores the band. UL now has FB monitoring equipment and applies for Official Observer position.

Traffic: VE4CM 170 UL 14 EL 9 QZ 2.



CORRESPONDENCE

The Publishers of *QST* assume no responsibility for statements made herein by correspondents

DX Scoring System

Woods Cross, Utah

Editor, *QST*:

I just got through reading "How to Count Countries Worked" by Clinton B. De Soto and I believe he has struck the DX nail right on the head. I, for one, am in favor of this system. The only drawback is countries like Argentina. The number in their call letters runs from 1 to 9 inclusive, but there are no defined areas for each number.

—Chester R. Ashby, W6DTB

Acton House, Felton,
Northumberland, England

Editor, *QST*:

A definite ruling about how to count countries worked was much needed and I have just read your article in October *QST* with great interest. Incidentally I have been able to add another country to my list of those worked, as previously I had counted PK1 and PK4 as one! I note you say "The Federated Malay States are one country." That is VS2. How about the non-Federated States (VS3), and the Straits Settlements (VS8)?

As regards W4EG's suggestion of a "DX score," counting the number of districts worked in each country, I think this would cause some confusion. For instance, people would count G2, G5 and G6 as three districts, whereas the figures do not indicate any districts in Great Britain. For example: G2XT, G5QY and G6IR all live quite near each other in and around Newcastle-on-Tyne! There are probably other countries where figures in the call signs do not indicate different Districts. Of course W4EG's suggestion would be OK for W, VE, VK, etc.

—Barbara Dunn, G6YL

5100 Cornell Ave., Chicago, Ill.

Editor, *QST*:

Mr. De Soto's suggestion for a new DX scoring system is quite a good one—but why not use the time-tried system that A.R.R.L. uses in the International DX tests? Give one point for each foreign contact, total the contacts, and then multiply that figure by the number of countries worked. That seems to me a far better indication of all-around DX work.

—I. F. Lauman, W9MGN

EDITOR'S NOTE.—The theory of the DX Scoring System, as promulgated by W4EG, is not to place a premium on time spent on the air or amount of DX worked, but on coverage—which, it seems to us, is a fairer and more uniform criterion.

For answers to the queries contained in the above letters, and other moot points raised by correspondents, see the I.A.R.U. News department this issue.

Voting Age

S. W. Texas St., Portland, Ore.

Editor, *QST*:

Under our present set-up any kid member, regardless of age or experience, has a vote that carries the same weight as a mature and experienced member.

As citizens we do not qualify ourselves to vote until we have reached the age of 21. The affairs of the A.R.R.L. should be given the same thoughtfulness that we give to our other interests if we are to make the most of our hobby. The Board would do well to bring up for discussion the age limitations of voting.

—Temple V. Ehnson, W7VS

Armistice

414 Redcross St., Wilmington, N. C.

Editor, *QST*:

I noticed in the October issue of *QST* a cartoon by an artist who evidently shares my sentiments.

The drawing represented a couple of fellows having a first-class brawl over the c.w.-'phone situation. Somehow, that cartoon wasn't so funny as it was serious. It was too near the truth for comfort because it is becoming a brawl in the verbal sense. Believe me, old John Q. Public is beginning to think so, too. Lots of people ask me why all the dissension in the ranks. What can I tell them but the truth? Just narrow-mindedness and dissatisfaction.

So, fellows, what about a silent period on the question? After all, what is there to be so excited about? I don't believe a bunch of fellows fighting like alley-cats will have much effect in changing the rules of the F.C.C.

But I do think the situation is hurting the grand old game of amateur radio. It's only a hobby, so let's don't violate rule number 6 which

plainly states: "Don't take yourself so darned serious!" Remember, "United we stand, divided we fall." Long live Amateur Radio!

—W. H. Humphrey, Jr., W4BPL

QSL Threats

54 Prince's St., Stockport, Cheshire, England

Editor, *QST*:

I received the enclosed card through the mail this morning. Is this an example of American courtesy?

I may say that since QSO No. 1 I have always sent a card for every QSO, but usually through the QSL Bureaus. I work several hundred local W's every year on 20 meters and I cannot possibly mail a QSL to each one direct for financial reasons. Don't your members use your QSL bureau to its full extent?

Cards such as the enclosed do nothing but foster ill-will and impress no one except the letter carrier for whom, perhaps, it was intended.

—R. H. Jackson, G6ZU

EDITOR'S NOTE.—The card reads: "Pse! Pse! Pse!!! Pse!!!! Pse!!!!!! Q.S.L.L.L. This is the second time I've written for a card. Why not be an honest ham at least. Yours (and the name and address)."

To G6ZU: No. American amateurs do not use our QSL Bureau to its full extent. There are in our district files perhaps 35,000 QSL cards which have not been called for in the past six months. Hundreds of American stations fail to send for cards, even when advised that cards are being held for them. Reason? Apparently, disinclination to QSL, no desire for QSL cards. DX stations who can persuade American amateurs to apply for cards held in abeyance for them (see rules elsewhere in this issue) will be doing themselves a service.

Milligoats

122 Eighth St., Augusta, Ga.

Editor, *QST*:

. . . I was working W4DND in Winterville, Ga., on the 160-meter 'phone band when I noticed the plate milliammeter on the output stage was just going crazy. First, it was drawing fifty milliamperes and then one hundred and fifty and back again to seventy-five. At the height of this performance I took a casual glance out of the window and noticed that the yard man had tied the kids' goat on the end of the counterpoise and that it was moving in circles around the back yard trying to get all of the choice grass that was available. Now I have had lots of trouble before with bugs in my radio, but never before goats. You probably know a goat has a very strong and distinctive carrier on the air most of the time, so from now on I am not going to measure the output of my set in milliwatts but in billygoats, and if you will be so kind as to notify the gang on 160 meters that if they will use nose 'phones and not ear 'phones, I think they will find my signals to be S9 and unmistakable . . .

—W. M. Harrison, W4DV

Directional CQ's

4 Tanner St., St. John's, Antigua, B.W.I.

Editor, *QST*:

. . . Several times recently I have had occasion to send directional CQ's and have been considerably annoyed by receiving answers from W districts not called. The offenders usually give extremely long calls and do not sign frequently so that by the time they do sign it is too late to search the band for calls from the desired district. Admittedly a QSO with a VP2 is a rare one with many W stations, but that is no excuse for not regarding a directional CQ.

Personally, I do not believe in calling a fellow down over

the air, so I either ignore the offenders entirely or make it a "hello-goodbye" QSO. It is time, however, that the gang realize that a call from an unwanted district is seldom appreciated, and that it is better to wait until the station stands by for a call from anyone or gives a general CQ.

An example of good judgment and common sense was observed recently. During a QSO with W5EHM I was asked if I had a schedule with any K5 station. I replied that I did not, but that if W5EHM had any traffic for K5 I would take it and try to push it through, making it clear that I could not guarantee being able to do so. Immediately after the QSO I called "CQ K5 msg K5AF" and received an answer from W9HUV who had a schedule with a K5 that same day. He accepted my traffic, and I hope, successfully relayed it.

Under other circumstances I might have been annoyed at being called by a W9 when I called "CQ K5," but on this occasion I greatly appreciated W9HUV's call.

May this serve in the future to encourage other hams to use their judgment before aimlessly answering a directional CQ.

—Eugène D. Vanier, VP2BX

EDITOR'S NOTE.—Emphasis on this point has been placed recently by numerous correspondent foreign stations. Directional CQ's, most useful of calling devices, are abused, *should not be*, for the good of the art.

About A.R.R.L.'s DX Tests

512 N. Main St., Wheaton, Ill.

Editor, *QST*:

The "DX Test Rules" letter in November *QST* by W5NW brings up a few points. One, very important I believe, is that the W/VE and the DX rules *need not be the same*. The trouble with just working each "prefix" and have the DX on the same basis, is that 14 QSO's are all that the DX stations need, and how are the W's going to work DX if they get their 14 and close down? Wouldn't be so bad to have the W's do that, then shut up until they hear a new prefix, but don't do that with DX stations or they will all quit on us. Of course, those of us not on the air during the week would have no chance in that kind of a contest, I guess, due to not being on 14 mc. while the W gang is at work.

It was most notable during the VK contest that those not on the edge had little chance. When on the edge here, 1 k.w. just makes you a member. A good antenna 70 or 80 feet high lifts you out of the mess a little. A reflector (W9TB) gives you better strength reports, and you run away with the contest. The low power fellow can't compete on the edge, and can't work anyone much if not on the edge. So we pile up more and more on the edge with high power. A good stiff handicap for high power, such as a multiplier of 4 for 50 watts, 3 for 100, 2 for 200, and 1 for above 200, would help spread them out and make up for the choice edge position.

The situation is getting bad, edge QRM is fierce, band from 7150 to 7250 is getting a bad hole (fine for hearing DX though)! I am almost to the point of suggesting a 50% penalty for operation in the edge 25 kc., a 25% penalty for being in the next 25%.

If you don't like the watt idea of rating, use the one of tube type, assuming running the pants off them.

204A, 852, 211, 203A, etc.: 500 watts per tube.

830, 825, or what have you: 200 watts per tube.

'10, 801, 841 (normal size): 100 watts per tube.

802, 59, 46, 47: 25 watts per tube.

If they can force more watts on the tube, that's OK. Starting with 25 or 50 watts, divide score by input/25 or 50, or divide score by 2 or 4 times power input. That means that 800 watts input has to divide by twice as large a figure as 400; same with 80 watts and 40 watts—etc. I don't mean to suggest both a frequency-discount and a power multiplier, but one or the other, if a large one, will do the trick. The driving stage must be limited to not larger than the final—or I could figure out a way to get plenty of watts through even a burned-out 471

—E. H. Conklin, W9FM

(Continued on page 68)



THIS PAGE is being written during a trip through the Middle-west and Southwest. We find there is something about a clean sheet of hotel stationery that makes technical discussions seem out of place, so we are just going to pass along some information on what the fellows out here are doing.

The main topic of discussion among amateurs everywhere we have been is the opening of the ten meter band to DX. One of the results of this has been to stimulate interest in improving antenna systems. Fortunately, ten meter arrays are small enough to be easy to erect, and the results are well worth while. As we have mentioned before on this page, many systems which work quite well at lower

frequencies are very poor at ten meters. For instance, one of the popular "noise-reducing" antennas proved excellent at frequencies as high as 14 MC., but was quite worthless at 28 MC.

Our reason for stressing this point is that we feel the antenna is the weakest link in the amateur transmitter. Regardless of frequency, in almost every case where something better than ordinary has been used as a radiating system, an outstanding signal has resulted: — such as 6CIN, 6ZH, 6CNE, etc. On twenty-meters, 5BDB's "signal squirter" is a notable piece of such gear. We understand a detailed description is being published in *QST*, so we will not describe it here. As a matter of fact, there is a great deal of information available to those who wish to undertake improvements. In addition to the many excellent articles on antennas in *QST* recently, John Reinartz has been handing out interesting data in his series of talks before clubs in the East and Middle West. The RCA bulletin to broadcast stations has also been publishing dope in recent issues on the effect of variations from the conventional in vertical radiator design.

At the airport in Dallas we saw a rather out-of-the-ordinary airplane radio installation. Instead of the conventional location of the receiver and transmitter in the tail of ship and operated by remote control, essentially all of the gear was located in the cockpit for direct operation. A concentric transmission line then ran to the tail of the plane, at which point an antenna coupling unit tied in to a trailing wire antenna.

At the same airport we saw another installation that interested us particularly. Two remotely located HRO receivers were operating without remote control. They had been tuned in three months before and left running night and day. No retuning had been necessary. All of which is additional proof of our contention that the small frequency drift of the HRO is remarkable. To be fair, we must share the credit with the transmitters, which obviously were holding frequency to close limits.

9LD uses one crystal and a precision electron-coupled oscillator. This combination allows him to slide gracefully around the band for calling purposes without running the danger of sliding out. We thought this a pretty nice system (that is, for the fellow with adequate frequency measuring equipment), until we later saw 9DRD's method of using a Hollister A-cut crystal with a single-knob-control frequency shift for the same purpose. Two of his variable frequency crystal units give almost complete coverage of the twenty meter phone band without any danger of getting too near either edge. The method of accomplishing this desirable end seems to be somewhat of a secret at the moment, but knowing Herb we expect that the details will transpire through the pages of *QST* pretty soon.

JAMES MILLEN



YOU DEMANDED A New CONDENSER

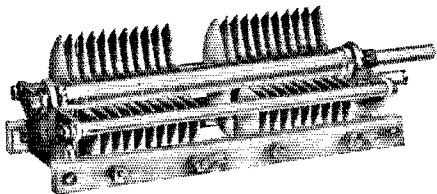

Here it is!

You asked for it—Now you have it!

The New Midway Condenser

(PICTURED ABOVE)

- ★ DOUBLE SPACING — ROUNDED PLATES
- ★ MYCALEX INSULATION
- ★ MIDWAY FRAME
- ★ SMALL IN SIZE — BIG IN PERFORMANCE
- ★ EMBODIES EVERY CARDWELL PATENT AND CONSTRUCTIONAL FEATURE!
- ★ INCREASED FLASHOVER VOLTAGE
- ★ 100 mmf. — EACH SECTION
- ★ PRICE TO AMATEUR — \$4.80

CARDWELL has developed 29 new condensers in past months — all sizes, frames and capacities, — single and double. The complete CARDWELL line is fully described in a New Catalogue. It's yours for the asking.

THE ALLEN D. CARDWELL MANUFACTURING CORPN.
83 PROSPECT STREET, BROOKLYN, N. Y.

CARDWELL

CONDENSERS

Correspondence Department

(Continued from page 66)

28-Mc. Bonus?

Canonsburg, Pa.

Editor, *QST*:

Had a swell three way tonight on ten, and I mentioned the idea that there should be a great big DX contest staged on 28 mc. VK3YP and W6DOB both agreed, and VK3YP said it would meet great favor with W.I.A. LU9BV, W8IXS and ZS1H have seconded our motion. It will put a lot of new stations on ten, and that is all it needs to get an idea what the band acts like.

I'm all hepped about ten! I think it has possibilities of all kinds. Boy, the way the VK's and the Europeans push background out of my receiver at times is unbelievable. While every one is on edge give an early announcement of a big ten meter DX contest. February would be swell, it's usually a crazy month with DX. I know from experience, *this ten meter band is the same as twenty only it has a greater skip packed into a shorter time duration* which means all kinds of things can happen that don't on twenty.

Frank Lucas, W8CRA

Editor's Note.—Italics ours. The biggest difficulty noted here with 10-meter contests is that the cyclic band conditions every so often bring a spell when results are entirely nil. This has led to the adoption of the "annual" type contest such as announced in November *QST* for the whole year 1936 in the belief that consistent progress was being made by this route. Plans are now being made for A.R.R.L.'s (March) International DX Contest. Last year a bonus was given depending on the number of bands on which DX was worked, which stimulated 28 mc. attempts greatly. Should we do it that way this year? Or would an extra bonus or multiplying factor for 28 mc. only be an acceptable part of our 1936 DX contest? A postal card to A.R.R.L. Hdq. will give us your views.

Thought Transference

629 W. 41st Drive, Los Angeles, Calif.

Editor, *QST*:

Noted with interest was the letter of Mr. L. L. Cook, At Sea, M.S. *Santa Barbara* in the August issue. He brings up a subject that has impressed experienced radio operators, commercial and amateur, with its frequency of occurrence; it can be taken lightly, or in a philosophical and psychic manner. How many commercial operators have turned in for the night, slept fitfully, finally got up, and on turning on the receiver heard themselves being called, an SOS, or some event of interest. It has happened innumerable times.

The Department of Psychology at Duke University has been carrying on experiments in psychic science, thought transference, etc. Some of their results can be read briefly in "Forum," etc. They feel there is something to it as it happens too frequently in a given number of experiments to be explained as casual. The mathematics of probability tend to prove such events are possible. The uncivilized persons of the earth believe in and follow hunches and feelings—failure to heed such warnings sometimes meaning death. Perhaps the operator at sea away from noise, the amateur at home in the quiet of his room, feel and translate these premonitions, hunches, etc. How about some of you experienced ops —commercial and amateur—speaking up?

—Joseph Dockendorf, W6JTC

Decadence

3131 Morgan St., Sioux City, Iowa

Editor, *QST*:

Though I've never gotten around to becoming an active amateur, I've followed the activities of hamdom with avid interest ever since the day back in 1924 when I found some old copies of *QST* amongst a bunch of mags which I was collecting for a school paper drive. I devoured their contents and became a ham in spirit if not in fact. Hams were dyed-in-the-wool enthusiasts then; but now they seem to be slipping into decadence along with literature and govern-

A Heritage of Quality

WESTON
Instruments

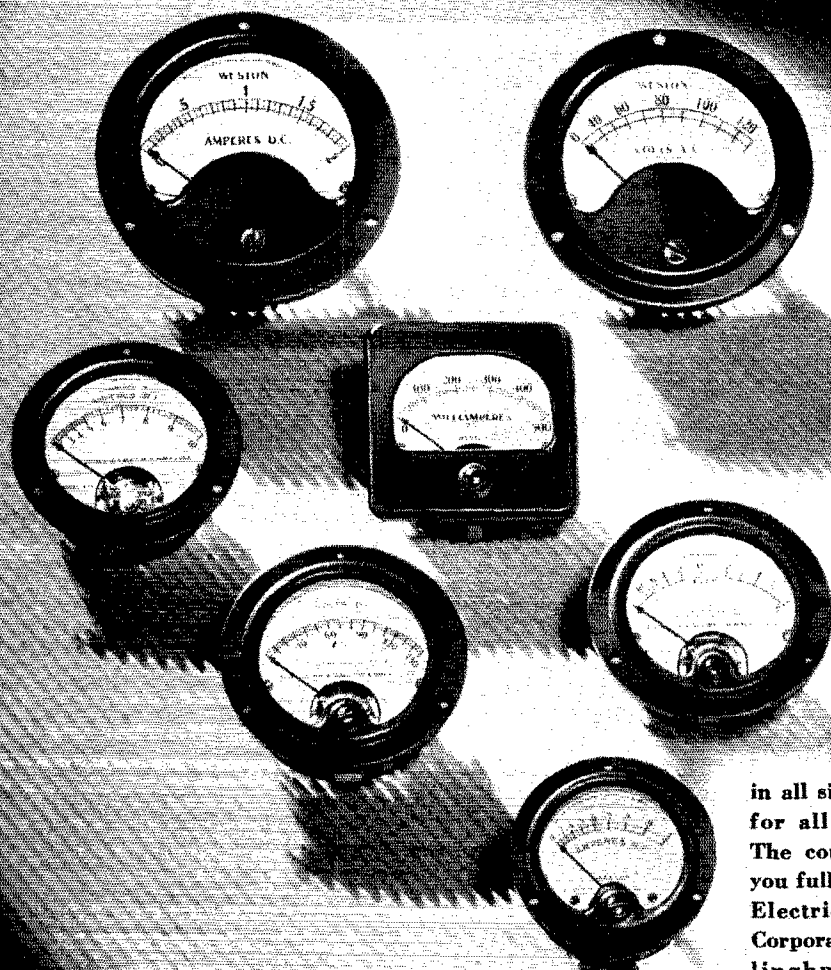

in all sizes, shapes, and for all requirements. The coupon will bring you full data... Weston Electrical Instrument Corporation, 602 Frelinghuysen Avenue, Newark, New Jersey.

WESTON ELECTRICAL INSTRUMENT CORP., 602 Frelinghuysen Avenue, Newark, N. J.
Send Bulletin on Weston Instruments.

Name _____
Address _____
City and State _____

This NEW AMATEUR COMMUNICATION RECEIVER

LESS NOISE



GREATER BAND SPREAD

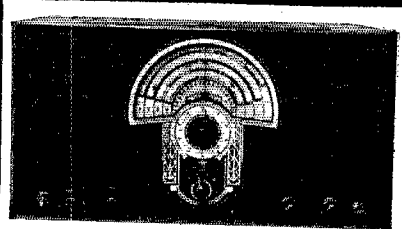

DESIGNED EXCLUSIVELY for 160-80-40 & 20M. HAM BANDS

FEATURES

- Extreme selectivity afforded by the sharply tuned antenna circuit, R.F. preselection and triple tuned double band pass link circuit I.F. amplification, 6 tuned circuits.
- Regenerative I.F., manually controlled. For single signal C.W. reception or extreme selectivity when desired.
- Extremely low background noise allows speaker reception of weak C.W. signals. (ON-OFF).
- Adjustable beat frequency oscillator.
- Single tuning control.
- No plug in coils.
- Stand by switch and phone jack on front pane
- Sensitivity on all bands 1 microvolt or better.
- Automatic and manual volume control.

HERE IS REAL ELECTRICAL BAND SPREAD

6 1/2" on the dial on the 20-M band, 5 3/4" on the 40-in. band, 4 3/4" on the 80-M. band, 3 3/4" on the 160-M. band.

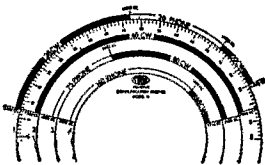

The low cost of this remarkable job is due solely to the fact that the Amateur is required to build part of the job himself. The Tobe Amateur Receiver is available with air trimming and padding condensers on all critical circuits.

THE TOBE SUPER TUNER

may be bought separately by the amateur who wishes to build his own receiver around his own pet circuit. Unit comes wired and tracked for 456 Kc (+ or - 10 Kc), with all accessories for mounting.

Your jobber can give you complete information on the Tobe Amateur Receiver and Super Tuner. If he cannot supply you — write us direct for complete FREE literature, parts list, etc.

TOBE DEUTSCHMANN CORP.

Canton Dept. Q. Massachusetts

ment. What's wrong? Too many chromium-plated gadgets and not enough genuine interest?

—D. E. Murphy

On Reporting

Des Plaines, Ill.

Editor, *QST*:

Up until a short time ago I was what might be called an honest to goodness satisfied ham, willing to go along minding my own business, and having been given the privilege to sit down at my desk and rag chew with some other fellow miles and miles away meant more to me than complaining about whether we should say QSA 5-7 or RST 559X or whether the signal strength report should go to 5 or 9. It gripes me every time I hear the fellows complain about reports, when there are other things they might complain about that are of much more importance. If the fellows want to snap it up a bit, then why not do as F. E. Handy suggests, and leave off the letters RST and just give the numbers, and if they want to use QSA 5-7 why not use it? We all know what it means. Anyway let's do something about it and settle it once and for all. . . .

—C. E. Machr, W9PUJ

Viewpoint

9, The Mead, Beckenham, Kent, England

Editor, *QST*:

I feel I must write and champion the letter from Dr. E. S. Burger, W9CHH, which appeared in the September issue of *QST*.

Amateur radio throughout the whole world is a very comprehensive hobby. By that I mean that there are so many different outlets; there are six popular bands on which anyone who has obtained his operator's license should be able to transmit and receive with efficiency, whether 'phone or c.w. If the 80-meter 'phone band is particularly crowded one night, what sane reason is there to start a "hate" against everyone causing it? If a ham two blocks away is using 500 watts and we can't hear much else, then there are still five other bands on which it is possible to have enjoyable contacts. In the unusual event of six hams a block away all crowding us off the air on the six bands, then we still have radio as a hobby in the constructional sense, or we can visit some of our radio friends. After all, had it not been for amateur radio we should not have made these friends.

W9CHH rightly says that the trend of science has given us frequency stabilization and extremely selective crystal receivers. Hams would have much more right to complain if the present day number of amateurs throughout the world were operating under 1925 conditions. Where would DX or even local contacts be then? The answer is, I think, that the hams who have come into the game during the last four years and who are the chief complainants, would not have been radio amateurs, because it would not have been possible.

I know there are many people who are never happy unless they are grumbling, but before they get all het-up next time and rush into print and give the beginner a wrong impression of it all, let them think how lucky they are with the natural growth of our hobby to have such wonderful opportunities to enjoy it.

Now let's see if I can raise that W6. Perhaps QRM will prevent me—but never mind, it's fun trying!

—H. A. Maxwell Whyte, G8WY

A Zedder Chats

University of Otago, New Zealand

Editor, *QST*:

I wish to express appreciation for all the good things that one has garnered from time to time from your excellent journal, *QST*. My own rig expresses this perhaps more eloquently than any words of mine, and, curiously enough, all the stunts introduced into the outfit work first time!

So I thought it was about time I said so and expressed thanks.

The rig has a Universal Exciter (*QST*)—a 46 and a '10 modulated Class B (*QST* circuit) and an 852 for c.w. working

The BOOK

You Need!



Tells how to build a Real High Power Transmitter
— Step by Easy Step
— In *Progressive Usable Units!*

You've always dreamed of going on the air with a real high power job . . . seen yourself as the boss of an outfit to be proud of . . . Well, here's your chance to get that way by easy steps . . . each one a real economical addition . . . each one usable and practical! This sensational new book tells you just how . . . outlines each progressive step in simple, easily-followed fashion. Get it right NOW!

Get It HERE!

You can get a copy of the "Progressive" Transmitter Guide at almost any live radio jobber's, at better newsstands, or write for the name of nearest distributor to Amateur Press, 1300 W. Harrison St., Chicago, Ill.; General Transformer Corp., 500 S. Throop St., Chicago, Ill.; The National Co., 61 Sherman St., Malden, Mass.; The Aerovox Corp., 70 Washington, Brooklyn, N. Y.; Guardian Elect. Mfg. Co., 1528 W. Adams St., Chicago, Ill.; Beede Instrument Co., Penacook, N. H.; Crowe Nameplate & Mfg. Co., 1749 Grace St., Chicago, Ill.; or Bliley Electric Company, Erie, Penna.

Once you've looked over this book you'll admit that it's the biggest two-bits' worth ever offered the ham who wants to keep abreast with what's going on in the world. Chock full of helpful hints, the real low-down on high power transmission—and how to get it. Photographic illustrations of every unit, and practical circuit diagrams for every hook-up—eleven of 'em that show you each progressive step, and all its whys and wherefores. Best of all, the diagrams are not "trick" circuits rigged up to sell you new tubes or fancy folderols . . . instead, they are the best, most practical and time-tried circuits that have proved to be real performers, and designed to get you on the air quick. Your Uncle Dudley, who puts up the old mazuma, will approve of this, for it doesn't put the big drain on his check-book all in a heap, but spreads it out so that it can be taken care of from time to time as the funds increase. Don't hesitate a minute—get this big, interesting, practical book—and get yourself on the air in the Hi-Power Class, quicker and better.

It's Ready NOW

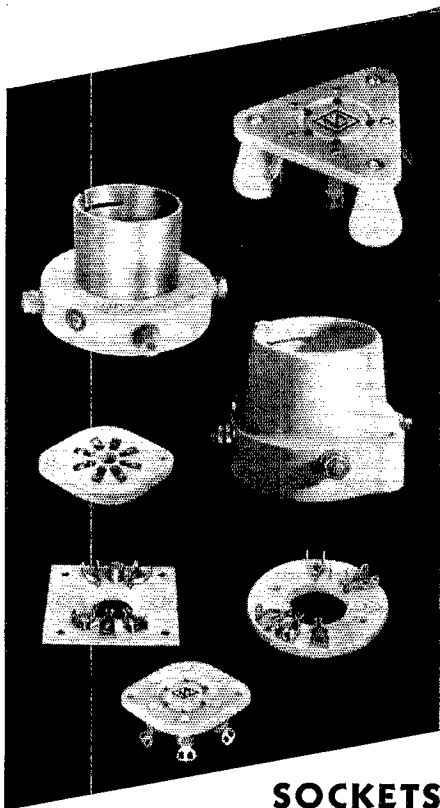

SOCKETS

■ National has a socket for every amateur need. A few are pictured above. At the top right is the big JX-100, a wafer-type low-loss socket for power pentodes such as the RK-28 and RCA-803. Below it are two fifty-watt sockets with sturdy side wipe contacts. Type XC-50 is entirely of low-loss Steatite, while type XM-50 employs the more conventional metal shell and is lower in price. Next comes the Isolantite wafer socket for Octal (metal) tubes, followed by two sockets for acorn tubes. The acorn pentode socket is assembled on a square aluminum base and has built-in by-pass condensers for stable high frequency operation. The Acorn triode socket has an Isolantite base. And last, but by no means least, is the amateur's favorite receiving tube socket.

NATIONAL COMPANY, INC.
MALDEN, MASS.

with a matched impedance Zepp (QST) using the stub feeders.

I am delighted with this last, and I can put 400 watts into the 852 without the slightest flash on the tube plate. I wonder what it would stand without any fuses. The interstage coupling is the modified link coupling described recently.

The driving tube 10 is a special one with an extra large plate and it can push the r.f. meter 0-2 amps hard over. The receiver is the 5-tube S.S.S., now fitted with a T.P.T.G. regenerative r.f. stage (QST), and its aerial is one of your "noise reducers." By the way, I couple the r.f. stage with a two-turn link, the detector end being $2\frac{1}{4}$ inches from the grid coil and, in between, a Faraday shield. Thus I can use now regeneration on the r.f., detector and i.f. stages without any trouble at all—each is controllable and thus the receiver is adjustable to almost any condition.

Am very tickled with this rig. Of course it is shielded individually as well as by water-tight compartments.

I have read in your journal many times matter concerning the use of CQ DX, etc. Why don't your members all see how true it is? Experience of Empire contests have convinced me that the matter of raising DX is one for thought, concerning conditions in the desired country and the numerical incidence of "hams"—also the number likely to be on the air at the time. For instance, in the early evening here, there is a great deal of local QRM and working W's is not so hot but later between 11 and 12 p.m. conditions are quiet, and although the W signals are comparatively weak (compared with earlier) yet good "ragchews" are usually possible. My rule here is: Call CQ for W's, and call the station for Europeans and Asians.

The latter use, for the most part, little t.r.f. receivers and they can swoop over the band and pick one up if loud enough for them.

Now most of us here use "Sniggles" of the home grown variety, and we cannot swoop over the band. It takes time to analyze all the signals and I seldom get to half-way up the band before the average time of a call is spent. So working from my own frequency 7282 kc., I collect anybody near me only and miss the rest. To get the top half I have to use the top xtal and call there.

Apart from the new indications concerning how one is going to cover the band, it is a safe bet that most hams listen for W-DX near themselves.

I mention this because some W's have told me they could not raise me for weeks and yet they have an R6 signal and QSA 4-5; the reason being they are not near my call. I notice the W's use this convention too and the only time I would answer a CQ from a W is when he is sitting pretty right near me.

The surprise of some of them at a call is amusing. Of course I realize that the W's have other fish to fry besides ZL's but may need the ZL or VK card and in any case, there is a pretty good feeling between W's and ZL's and most of us could not wish for anything better than a W ragchew.

Finally I am lost in admiration of your 20-meter 'phones and if my signal sounds in U.S.A. like the great majority of W's sound here on 40 meters—then the T9X report is no exaggeration.

—(Dr.) R. B. Dodds, ZL4FK

Book Review

Making a Living in Radio, by Zeh Bouck. 222 pages, including three appendices and a comprehensive index, 25 illustrations. Published by McGraw-Hill Book Co., Inc. Price, \$2.00.

"... One's training as an amateur provides the finest foundation for any sort of radio work—from servicing to engineering [italics the author's]. The amateur is exceedingly well-informed on radio because to him learning is a pleasure. His heart, as well as his ambition, is wrapped up in radio ... "but" ... the author does not believe that the opportunities for making a living in radio are truthfully implied in those school advertisements directed to an emphatic you, giving you the choice of plodding through life with a thin pay envelope, or riding luxuriously through the years in a high-priced car. ... Of those who sign the

WHEN YOU BUILD IT

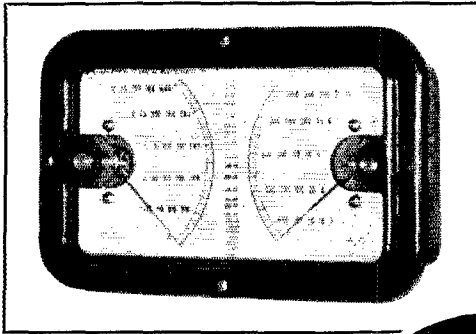

TRIPLETT "TWIN"
(In any combination of
A.C. or D.C.)

USE ONLY
Good
INSTRUMENTS

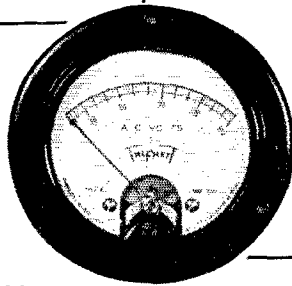

TRIPLETT
A.C. Volt Meter
Model No. 331

QUALITY SHOULD BE YOUR GUIDE

Triplett offers Precision without extravagance. A complete line — attractive and distinctive.

Your panels are always improved in appearance — acceptance and accuracy of control with Triplett instruments.

A big selection of models and ranges from which to choose.

GET THEM AT YOUR JOBBERS

Write for Catalog

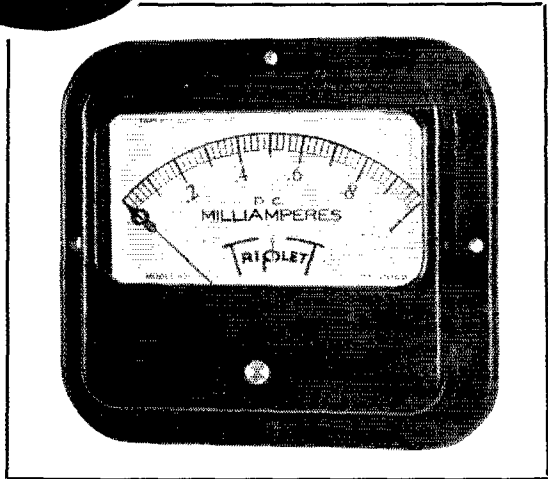

TRIPLETT D.C. Milliampere Meter, Model No. 421

MAIL THIS COUPON NOW

Triplett Electrical Instrument Co.
2512 Harmon Ave., Bluffton, Ohio
Please send me catalog of complete information on Triplett Instruments.....

Name.....
St. Address.....
City and State.....

TRIPLETT MANUFACTURES

a complete line of electrical and custom built. If you have an measuring instruments for radio, electrical and general industrial purposes both standard electrical instrument problem write to TRIPLETT. See them at your jobbers.

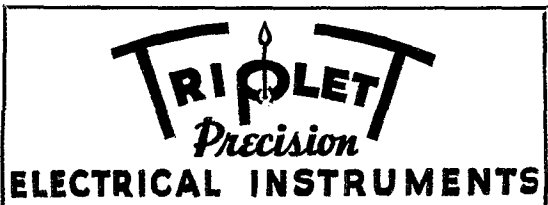

Now—a high-Powered—

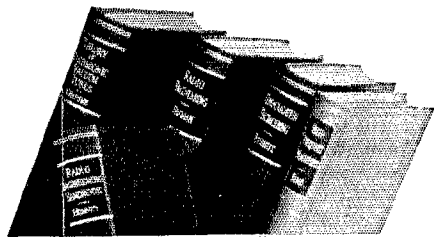

RADIO ENGINEERING LIBRARY

—especially selected by radio specialists
of McGraw-Hill publications

— to give most complete, dependable coverage
of facts needed by all whose fields
are grounded on radio fundamentals

— available at a special price and terms.

These books cover circuit phenomena, tube theory, networks, measurements, and other subjects — give specialized treatment of all fields of practical design and application. They are books of recognized position in the literature — books you will refer to and be referred to often. If you are a researcher or experimenter — if your interest in radio is deep-set and based on a real desire to go further in this field — you want these books for the help they give in hundreds of problems throughout the whole field of radio engineering.

5 volumes, 2981 pages, 2000 illustrations

1. Everitt's **COMMUNICATING ENGINEERING**
2. Terman's **RADIO ENGINEERING**
3. Chaffee's **THEORY OF THERMIONIC VACUUM TUBES**
4. Hund's **HIGH-FREQUENCY MEASUREMENTS**
5. Henney's **RADIO ENGINEERING HANDBOOK**

Special Low Price and Easy Terms

Bought singly, the five volumes comprising this library would cost you \$26.00. Under this offer you save \$2.50 and, in addition, have the privilege of paying in easy installments beginning with \$2.50, 10 days after receipt of the books, and \$3.00 monthly thereafter. Already these books are recognized as standard works that you are bound to require sooner or later. Take advantage of these convenient terms to add them to your library now.

SEND THIS ON-APPROVAL COUPON

McGraw-Hill Book Co., Inc.
330 W. 42nd St., New York, N. Y.

Send me Radio Engineering Library 5 vols., for 10 days' examination on approval. In 10 days I will send \$2.50, plus few cents postage, and \$3.00 monthly till \$23.50 is paid, or return books postpaid. (We pay postage on orders accompanied by remittance of first installment.)

Name.....

Address.....

City and State.....

Position.....

Company..... QST-12-35

(Books sent on approval in U. S. and Canada only.)

coupon and take the course, many will ride and many will continue to plod. It does not necessarily follow that all those who fail to clip and sign will always plod." Thus in a 23-page introduction Mr. Bouck proceeds, with somewhat tolerant honesty, to debunk the various fields in the radio profession from the "glorious opportunity" viewpoint. At the same time, he makes out a case for radio as a vocation adequate to support the remaining chapters on how to accomplish that desired end. As with his characterization of the correspondence schools, Mr. Bouck's volume will not set one forthwith on the royal road to riches or transform one overnight into the "swank young 'Sparks,' in full regalia, promenading up and down the boat deck with a fair damsel on each arm." But that does not make it the less worth reading for the individual who feels himself at the crossroads of decision—or, for that matter, by the already-established radio career-man who seeks a proper perspective on his profession. A workman-like production, authentic, interesting, useful.

—C. R. D.

Kansas State Convention

FOR the second consecutive year Capt. W. A. Beasley, W9FRC, of the Kansas National Guard, was elected outstanding Kansas amateur at the tenth annual state A.R.R.L. convention at Topeka, October 5th and 6th. The Topekan, secretary of the Kaw Valley Radio Club, convention host, whose amateur experience totals nearly twenty-one years, was awarded for the second time in as many years the traditional Kansas Wouff-Hong trophy, made from wood from the lower foreyard of the famous U.S.S. *Constitution* — "Old Ironsides."

To Clifford W. Johnson, W9BUY, of Independence, was awarded a special plaque upon which was mounted the rotor of a rotary spark gap, with place inscribed in recognition of his sponsorship of the first annual Kansas amateur convention, held at Independence.

Approximately 200 OM's, OW's and YL's from six states—Kansas, Missouri, Nebraska, Iowa, Colorado and Oklahoma—attended the two-day session, with its two banquets, round-table sessions for 'phone and c.w. operators, and special meetings for the A.A.R.S., the U.S.N.C.R., the pioneer Kansas convention gang, and the CX7 Association, including operators connected with the annual schedules with the Kansas National Guard encampments at Camp Whitside, Fort Riley.

Speakers included Brig. General M. R. McLean, adjutant general for Kansas, who paid high tribute to the service of the radio amateur in the National Guard, Army Amateur and Naval Reserve nets and in general communication; H. H. Stephens, superintendent of the largest shops on the Santa Fe railroad, and president of the Topeka Chamber of Commerce; H. W. Kerr, W9DZW-GP, of Little Sioux, Ia., Midwest division director; O. J. Spetter, W9FLG, Topeka, S.C.M. and A.A.R.S. head for Kansas; Ray Solstad and Marvin Hogg, W9BHK, Junction City, Kan., who demonstrated a high-frequency aircraft transmitter and receiver; Jules Herbeveau, W9SGM, of NBC, Chicago, talking on "Co-ordination between Broadcast Engineering and Programs"; J. W. McDonell, radio inspector, Kansas City, Mo., on "F.C.C. Regulations and

BARGAINS

**New Low Prices
ARMY AND NAVY
RADIO SURPLUS**

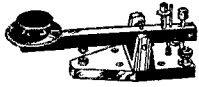

Army Aircraft Type J-3 solid brass transmitting key, large Tungsten contacts, beautiful action. \$1.50

U. S. Army Morse Key and Sounder — mounted on panel. \$1.95



ARMY HEADPHONE RECEIVER
100 ohm. \$75
U. S. Navy Phones. 80 ohms. Excellent for practice and code instruction for various purposes. High grade make. \$75

Complete portable telephone outfit. Has heavy bronze breast-plate with 25 ft. water-proof wire and plug. Used with dry cells and 100-ohm mike transformer. \$3.95

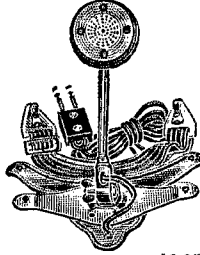

Radio Frequency Driver 6000 to 30,000 meters. Navy type SE1603. Cost \$180. Special. \$7.50



Western Electric Relay with Adjustable Platinum Contacts. Capable of controlling a local circuit of comparatively high voltage, with a very low primary consumption. (6 volt battery.) \$3.50
Army Signal Corps 20-Ohm Telegraph Sounder. For operation on 6-volt battery or dry cells. \$1.50
Turbo-generator, Westinghouse 4000 R.P.M., 10 KW 120 DC 150 Lb., used \$175.00 new. \$325.00
Relays, W. E. type "E" high res. multi-contact. \$75
Decremeter, Kolster, Bureau Standards type "C", 300 to 10,000 meters. \$35.00

**EDISON STORAGE BATTERIES
ALL TYPES
1.2 VOLTS PER CELL**



A & B Type

A-4 Amps. 175. Per cell. \$3.50
A-6 Amps. 225. Per cell. \$4.00
A-8 Amps. 300. Per cell. \$5.00
B-4 Amps. 90. Per cell. \$3.50
M-8 Amps. 11. Per cell. \$1.00
L-40 Amps. 25. Per cell. \$1.50
J-3 Amps. 37. Per cell. \$3.00
A-12 Amps. 450. Per cell. \$10.00



L & M Type



(J-3 cells)
NEW — Edison Storage Battery, Army Type BB-1, 10 volt, 37 amp., contains 7 cells. Complete in steel portable case. \$15.00

Resistors, Edison base W.L. 600-900-2000 ohm. \$25
Western Electric type 21AB condensers, 1000 V. a.c. test. Three capacities, .125, .25 and .5 mfd. Each. \$75
Wireless Spec. copper glass leyden jar, 10,000 working voltage, .002 mfd. \$2.00
Brunnell Resistance Box. 1 to 10,000 ohms. A beautiful piece of laboratory or test apparatus. Complete with plugs. Special price. \$15.00
Switchboard, 8-line portable Western Electric. Magnetoringing dry cell talking circuits. 8 drops, 20 anti-capacity key switches. Regular price, \$175. Special \$30.00

**MOTORS GENERATORS
CONVERTERS DYNAMOTORS
MOTOR GENERATORS
of all kinds at low prices.
Write for quotations**

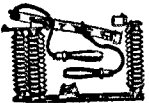

Lightning switch, ceiling type, heavy brass. Can handle 10 K.W. \$4.50

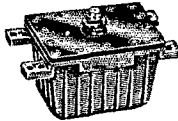

Condensers, Mica, op. volts 12,500, cap. .004 Dubilier, new. \$17.50
Dubilier, used. \$15.00
Wireless spec. new. \$15.00
Wireless spec. used. \$12.50
Condenser, Dubilier, mica, volts 40,000, cap. .0012-.001-.0008 or .003. \$10.00
Condenser, Dubilier, mica, op. volts 8,500 cap. .004. \$5.00
Condenser, Dubilier, mica, op. volts 8,500, capacity .0004 mfd. \$5.00
Condensers, Murdock .002 mfd. 5000 volt. \$1.00
Westinghouse Type LD oil condensers — 3.6 mfd. 3500 v. operating. \$30.00
.47 mfd. 10,000 v. operating. \$70.00

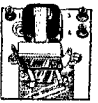

MINNEAPOLIS HONEYWELL LOW CURRENT
AC Relay, single pole, double throw, silver contacts, will handle 30 amps. 110 or 220 volt. \$3.00

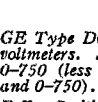

METERS
GE Type DO-14, 3 inch flush mounting voltmeters. Single scale 0-25, 0-250, 0-750 (less external resistors on 0-250 and 0-750). \$3.50
Roller-Smith 0-10 milliammeter, 3 inch flush mounting. \$1.95
Vollmeters, D.C. portable new Weston model 45, 3 scale 0-3-15-150 guaranteed 1/4 of 1% accurate. \$40.00
Ammeters, D.C. portable, new Weston model 45, 3 scale 0-1.5-15-150 with 3 scale external shunt and leads 1/4 of 1% accurate. \$30.00

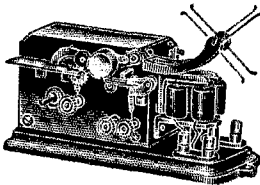

Telegraphic tape register 10 ohms. May be used to intercept dial phone calls. Has innumerable uses. Used \$15.00. Reconditioned. \$20.00



Baldwin Headphones. Genuine Mica Diaphragm 2000 ohm. Regular \$15.00 value. \$3.50



Anti-Capacity Switches
W.E. 12 and 14 Terminals, all with Platinum Contacts, value \$3.50 each. Our price, 95c each.

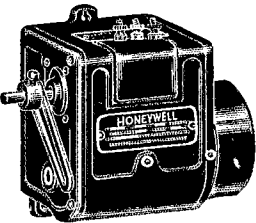

Famous Minneapolis Honeywell furnace heat control motors. Will open and close damper automatically and maintain even temperature when used with thermostat. \$12.50
With built in switch for operating blower, furnace fan, oil burner, etc. \$15.00
We also have Blower with motor. \$12.50

We have on hand thousands of items, too numerous to mention, suitable for laboratory, shop and experimental use. New items are received daily. A visit to our seven story warehouse will be well worth your while. We invite inquiries on the various pieces of equipment listed on these pages, or on your needs which we can probably supply, at bargain prices, from our immense stock.

MANHATTAN ELECTRIC BARGAIN HOUSE, Dept. Q, 105-7 Fulton St., New York City

Fear not

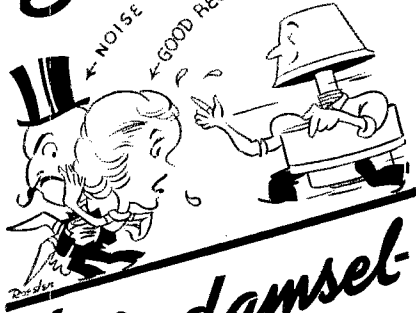

fair damsel
CENTRALAB
 will save you

?!!! that noisy control. This calls for heroic action, my good man. Get **"CENTRALAB,"** the serviceman's friend if you would save the goil.

Thousands of servicemen, everywhere, know the secret of smooth, noiseless controls... **CENTRALAB.**

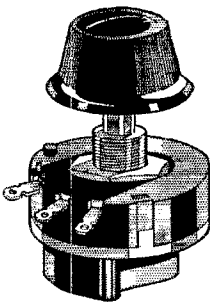

For "better than ever before" results use **CENTRALAB RADIOHMS** for replacement... a small stock services practically all makes.

Every Radio Service Man should be a member of the Institute of Radio Service Men.

Centralab

MILWAUKEE, WISC.

RADIOHMS SUPPRESSORS
FIXED RESISTORS

the Amateur"; J. W. Brennan, field engineer, radio division, General Electric Co., "Engineering Behind the New Metal Tubes"; Captain Beasley, W9FRC, "1935 Amateur Radio Activity at Camp Whitside"; Herb Hollister, W9DRD, Merriam, Kan., "A Four-Band Exciter Using Type 53 Tubes"; and Norman Wilson, of Midwest Grunow, Inc., Kansas City, Mo., on "A New Hook-Up for the Ham."

Demonstration of a new high-power pentode transmitter, using RK28's, by Kenneth Payne, W9AIL, Kansas City, Mo., and of behavior of ultra-high-frequency waves by Prof. J. D. Strathan, of the University of Kansas, Lawrence, closed the technical program.

John H. Amis, W9CET, president of the K.V.R.C., presided at convention sessions. The special awards and prize distributions closed an eventful two days, the ladies remembering a special program and their own special merchandise awards, and all conventionites looking forward to the annual Midwest division convention to be held in Topeka in 1936.

—N9DEB

Northwestern Division Convention

THE tenth annual Northwestern division convention, held in Spokane on August 24th and 25th at the Hotel Spokane and Liberty Lake, was, to the convention committee ably commanded by W. L. Miller, W7AAN, merely the climax to three years of intensive planning and preparation, but to the rest of us who were there it was a distinctive and unique experience—one of the finest ham conventions ever held.

The program—miracle of miracles—was carried off almost precisely on schedule. At 10:30 Saturday morning the business meeting was called to order. Even at that early moment the success of the convention from an attendance standpoint seemed assured, for all during the previous day and evening OM's, XYL's, and YL's had been registering from all over the division. More than 150 were assembled at the opening session, which, following an address of welcome by Chairman Miller and responses, was featured by the reading of Director Gibbon's annual report by Alternate Director A. L. Smith of Missoula. Clinton B. De Soto of A.R.R.L. Hq. then briefly discussed the A.R.R.L. in general terms. At this point one of the pronounced highlights of the convention appeared—Dr. Eugene C. Woodruff, director of the Atlantic Division and chairman of the Cairo Committee, discussing the work, functions, and plans of the Committee. The assembled amateurs listened intently to this exposition, filled as it was with information not hitherto generally known, until noon, when, following routine announcements, the meeting was adjourned.

Concurrent with the Dutch luncheon in the Silver Grill was a code speed contest held at Kinman's business school, won by W7ABX, and the assembly of the YF's for the afternoon mati-

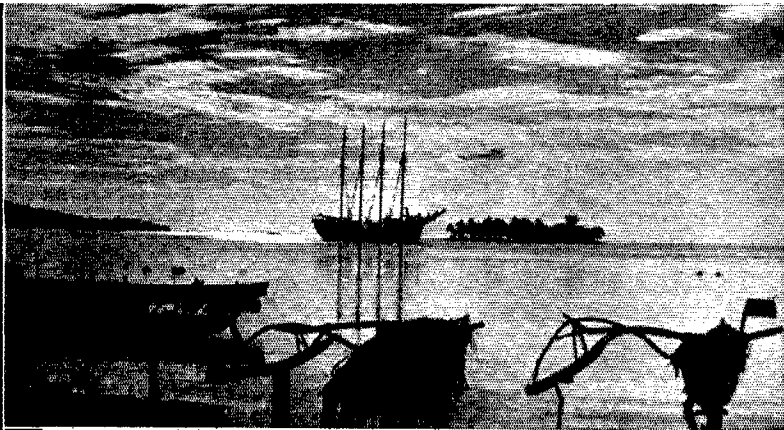

ABOVE: *The Schooner Seth Parker at anchor off Papeete, Tahiti, just before it encountered "the worst hurricane in 22 years."*

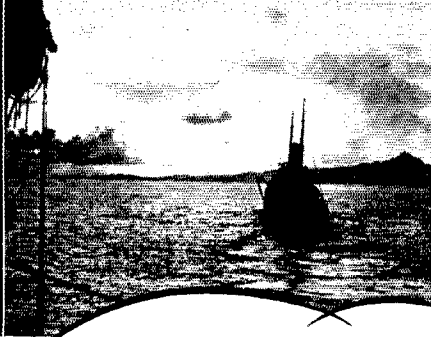

LEFT: *U. S. S. Ontario, naval tug, towing the Seth Parker after Tahiti hurricane.*

*"Extreme Need Arose and
an S.O.S. had to be sent"*

When the Schooner *Seth Parker* "encountered the most serious hurricane of the past twenty-two years off Tahiti," every man in her crew was glad Captain Phillips Lord had chosen BURGESS Batteries to power the *Seth Parker's* radio.

Captain Lord gave us this dramatic account of the reliability of his BURGESS Batteries: "Our radio equipment was badly damaged, but thanks to material like the Burgess Batteries which we had in our field amplifier and our receiving equipment, we were able to keep our emergency set in operation so we were at all times in communication with H.M.A.S. *Australia* and the U.S.S. *Ontario*. Our Burgess Batteries had been used for over a year on all of our broadcasts from the Schooner to the United States, yet when extreme need arose and an S.O.S. had to be sent, they still functioned perfectly."

If you want batteries with longer life and power to meet emergencies, ask for BURGESS, and look for the familiar black and white stripes on the batteries you buy. BURGESS BATTERY COMPANY, Freeport, Illinois.

BURGESS

AMPEREX HF 200

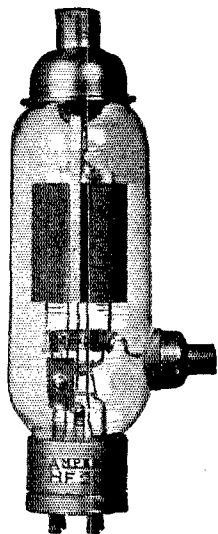

List Price \$24.50

Ultra High
Frequency
Power Tube

RADICAL
in design

STARTLING in
performance

The tube with the highest ratio of Transconductance to Interelec- trode Capacitance

A design characteristic which is mainly responsible for the extraordinary performance of these tubes at ultra high frequencies. Plate power outputs as high as 400 watts have been obtained from a single tube at five meters.

There are many other brilliant engineering refinements and radical design developments incorporated in the structure of these tubes as well as the entire line of Amperex Carbon Anode Tubes. They are described in an attractive folder containing tube data and characteristics which will be mailed to you on request.

A partial list of Amperex Tubes suitable for Amateur and Experimental work is listed below:

HF200	400 Watt Plate Power Output..	\$24.50
211-H	175 Watt Plate Power Output..	17.50
203-H	175 Watt Plate Power Output..	17.50
211-C	150 Watt Plate Power Output..	17.50
211-D	150 Watt Plate Power Output..	15.00
830-B	50 Watt Plate Power Output..	10.00
801	25 Watt Plate Power Output..	3.25
872-A	Mercury Rectifier	17.50
866	Mercury Rectifier	4.00

AMPEREX

Electronic Products Inc.

77 Washington St. Brooklyn, N. Y.

nee and tea. At 2:30 the gang again met in the Stone Room of the Hotel Spokane, where they were edified by an address by Inspector Frank Keenan of the Spokane Police Department, who called on his radio cars and motorcycle cops to raid the joint. The first group arrived in 2½ minutes, but it was six minutes before enough of them had assembled to carry the suspect they sought, Don Wallace, W6AM, off the scene. This out of the way, Prof. H. F. Lickey discussed "Antennas and Transmission Lines" in terms of fundamentals which the newest amateur present could follow and appreciate. A general discussion of the physical aspects of modulation and the general circuit adjustments and requirements involved was presented by Clint De Soto of Hq. under the title "Mechanics of Modulation." Concluding the afternoon session, Dr. Woodruff discoursed in his inimitable style on the portable "building block construction" transmitter he had with him, and sundry ballied subjects.

The banquet in the evening was a crowning achievement. It was orderly, pleasant, not overcrowded, and the food and good-fellowship were equally good. Perhaps best of all (to quote certain expressed opinions literally), there were practically no speeches, the sole offender in this connection being Clinton B. De Soto, representing the I.A.R.U., who discussed some aspects of the international situation. A touch of endearing sentiment was recorded with the presentation by Mrs. T. W. Baird, Sr., of the "Tommy Baird Cup" (to be awarded annually by the Ve Lambda fraternity to Spokane's leading amateur), to Nelson Collett, W7BBY. Doubly popular was he in view of the drawing of the many splendid prizes, at which he officiated.

Fittingly, this report should end with a roll of honor for all the fourteen fellows and added XYL's who made this convention the success it was. Space forbidding, we say simply, FB, OM's, and CUAGN.

New Crystal Microphones

SEVERAL interesting new microphones of the popular crystal type have appeared upon the amateur horizon recently.

A special "Communications-type" diaphragm crystal microphone has been developed specifically for speech transmission. This microphone, which is of the pressure-actuated diaphragm variety with bimorph crystal element, has a rising characteristic which is 10 db down at 60 cycles and 10 db up between 2000 and 2500 cycles, reaching normal response (rated at -60 db at standard zero level and sound pressure of 10 bars) at about 400 and 4500 cycles. It is stated that the rising response characteristic concentrates the speech power in the intelligibility frequencies, the medium frequencies which contribute the speech articulation, resulting in crisp, clear speech. A flat response characteristic appears not to be desirable for the most effective utilization of a given amount of voice power in communications work, for then the greater.

REMARKABLE PRICE REDUCTIONS

On LEEDS Constructional Accessories
due to greatly increased demand

RELAY RACKS



Our Relay Racks are built to stand up under the heavy loads of modern transmitter construction. Uprights are made of $\frac{3}{16}$ " stock, $1\frac{1}{2}$ " wide. Welded angle supports, cross braces and sturdy cross bars insure extreme rigidity. LEEDS Racks unlike some units on the market, are drilled for panel mounting according to Bureau of Standards specifications.

Table Rack type RAD 36" high, $20\frac{1}{2}$ " wide, 12" deep, with a complete set of drilled and tapped panel mounting holes..... **\$5.75**

Shipping weight 30 lbs.

Type RBD rack 5'-8" high, $20\frac{1}{2}$ " wide, 12" deep, with a complete set of panel mounting holes..... **\$7.45**

Shipping weight 50 lbs.

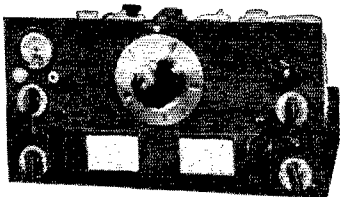

"The Cream of the Crop"

National HRO communication receiver in stock. Table model in cabinet, with tubes and coils covering from 1.7 to **\$167.70**
30 mc.....

HRO Power supply..... **\$15.90**

National HRO Speaker in cabinet **\$13.80**

New JX-100 Steatite 803-RK-28 socket in stock; each..... **\$1.80**

We carry a complete stock of all National Products.

LEEDS Leads as the only distributor in the country, handling GENERAL RADIO Amateur accessories and laboratory apparatus. Bulletin No. 936 mailed on request.

GENERAL RADIO coil forms type 677-U price 50c; type 677-V price 75c. G. R. amateur accessories always in stock.

GENERAL RADIO dials, with fluted knobs 4" — \$1.50; $3\frac{1}{4}$ " — \$1.25; $2\frac{1}{2}$ " — \$1.00.

EXCEPTIONAL VALUE — Westinghouse two wire 110-120 volt, 60 cycle kilowatt hour meters; five or ten ampere capacity. Specially priced at..... **\$3.50**

Shipping weight 15 lbs.

OVERSEAS AMATEURS ATTENTION

There is a satisfied LEEDS customer near you, regardless of your QRA. LEEDS export service is being used constantly by amateurs and professionals in 70 countries. One shipment will convince you.

Rack Panels



By LEEDS are furnished with black shrivell finish in the standard 19" length, $\frac{1}{8}$ " thick. Mounting slots are spaced according to Bureau of Standards specifications, insuring freedom from all trouble in mounting or interchanging panels.

Steel	Price	Width	Aluminum	Price
PS-1.....	\$.52	$1\frac{1}{2}$ "	PA-1.....	\$.74
PS-2.....	.57	$3\frac{1}{2}$ "	PA-2.....	1.03
PS-3.....	.68	$5\frac{1}{2}$ "	PA-3.....	1.30
PS-4.....	.71	7"	PA-4.....	1.55
PS-5.....	.95	$8\frac{1}{2}$ "	PA-5.....	1.90
PS-6.....	1.15	$10\frac{1}{2}$ "	PA-6.....	2.45
PS-7.....	1.30	$12\frac{1}{2}$ "	PA-7.....	2.90
PS-8.....	1.50	14"	PA-8.....	3.35
PS-9.....	1.70	$15\frac{1}{2}$ "	PA-9.....	3.70
PS-10.....	1.90	$17\frac{1}{2}$ "	PA-10.....	3.95
PS-11.....	2.05	$19\frac{1}{2}$ "	PA-11.....	4.45
PS-12.....	2.30	21"	PA-12.....	5.20

Brass panel mounting screws $\frac{1}{4}$ " long $10/24$ thread, 15c per dozen.

BASES and DEMI-BASES



By LEEDS for use with rack panels are now available in a greatly increased variety at lowest prices. Crystalline finished units of 20 gauge steel; each base is finished with a bottom cover plate, so that apparatus underneath the chassis may be kept free from dust and at the same time electro statically and electro magnetically shielded.

$8\frac{1}{2}$ x 8 x 2.....	\$65
$8\frac{1}{2}$ x 10 x 2.....	.70
4 x 17 x 2.....	.70
8 x 17 x 2.....	.95
10 x 17 x 2.....	1.10
12 x 17 x 2.....	1.30
8 x 17 x 3.....	1.15
10 x 17 x 3.....	1.30
12 x 17 x 3.....	1.40

LEEDS Leads the field with transmitting tubes, embodying the latest improvements in design, at lowest prices.

*203-A.....	\$8.45	†830-B.....	\$7.25
†210-HF.....	1.75	*838.....	11.75
866.....	1.50	†841.....	2.95
*211.....	8.45	845.....	11.50
†800.....	7.25	*852.....	11.50
†801.....	2.95	366-A.....	1.95

*Graphite Anode Tubes
†Isolantite Base

Tubes Shipped by Express Only

LEEDS Type 1-B

Freqmonitor

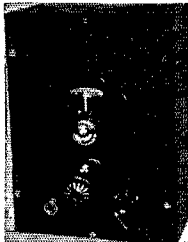

is now in use in hundreds of amateur stations. Licensed under Dow Patents. A complete description of this two purpose instrument may be found in the April 1934 issue of QST. "Ask the man who owns one." Complete with tubes and **\$19.75** calibration chart.....

Our type 1-E Power Supply is ideal for use with the 1-B priced at..... **\$6.50**

LEEDS 50 WATT SOCKET

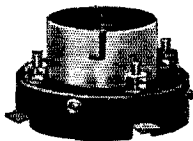

Heavy special porcelain base. Double phosphor bronze springs, high grade construction throughout. Extra **50c** special price.....



LEADS THE FIELD

World Wide Service to Amateurs

45 Vesey Street

New York City

Tel. COlandt 7-2612

Cable Address: "RADLEEDS"

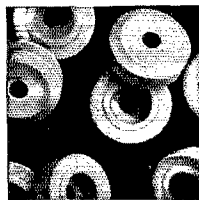

BUTT INS

are here at 25c per dozen. These midget lead through insulators and other Communication Products

Items now in stock.

NEW LOW PRICES

RCA 866's..... **\$2.25**

RCA 852's..... **\$16.40**



TOBE KITS IN STOCK

The finest low cost communication receiver on the market. Complete kit..... **\$41.40**

Wright DeCoster 8" speaker in metal cabinet..... **\$4.90**

Receiver cabinet..... **\$4.80**

Complete kit RCA tubes..... **\$3.32**

Wiring and testing for lazy hams, including single signal reception with regenerative I.F..... **\$6.50**

THESE SPLENDID BOOKS FREE!



THINK OF IT! 2 books full of invaluable information, to be had for just the mailing costs! One with 20 complete transmitter designs including 12 tested transmitter RF section designs and 8 modulator and speech amplifier designs. Circuits, complete parts specifications, inductances, etc. all included. Outputs ranging from a little fellow all the way up to the big ones comparable to the best broadcasters.

Ten complete designs for public address amplifiers in the other book. It includes one for every purpose, from 3 Watts to 30 Watts output, tried and tested designs that you can build, with complete parts lists for each.

These books should be in every amateur's technical library. They are invaluable for reference purposes. Just 22 cents in stamps brings them both to you. Send for your copies today.

**STANDARD
TRANSFORMER
CORPORATION**
856 Blackhawk Street, Chicago, Illinois

MAIL THIS COUPON!

STANDARD TRANSFORMER CORPORATION
Dept. A, 856 Blackhawk St., Chicago, Ill.

I am enclosing 12c for Transmitter Manual

I am enclosing 10c for Amplifier Manual

Name.....Address.....

City.....State.....

amount of the side-band power is concentrated in the low-frequency components, which are relatively unimportant from the standpoint of intelligibility. The new type microphone, it is claimed, will, in effect, approximately double the useful side-band power for speech, which is equivalent to squaring the effective modulation percentage. It should be operated into the relatively low impedance of $\frac{1}{2}$ megohm, to limit bass transmission. Greater over-all speech-amplifier gain will be required, since the higher frequencies inherently possess less amplitude than the low. In appearance, the new microphone, which is manufactured by Shure Brothers Company and is called their Model 70S, is similar to other low-priced crystal microphones.

A double-diaphragm microphone is another new crystal type. Acoustic energy is applied simultaneously to the two diaphragms, both flexing the crystal, resulting in increased output. The diaphragms are less than one inch in diameter, which results in very little sound-wave distortion, no cavity resonance, and no pressure doubling at the higher frequencies. This method of construction increases the capacitance of the active elements, resulting in less loss in long cable lines. The response curve shows that the output (into a 5-megohm load) is flat within 2 db from 20 to 6000 cycles, with a rise to approximately 10 db at 10,000 cycles, occasioned by the natural period of the crystal. This rising characteristic offsets frequency distortion in line, amplifier, modulator and receiver, as well as "tone control mania" or even the more legitimate use of the tone control to suppress static and other noises. The output level is approximately -64 db at 8-inch speaking distance. The unit construction is very rigid and is not subject to damage through mechanical jarring. This feature, together with uniform frequency response, results in decreased feedback effects. It is regularly supplied with a two-wire shielded cable, enabling push-pull connection or connection to a de-coupled grid circuit with a supplementary ground, resulting in less hum, tube and resistor noise. Due to the small size of the unit, which is described as the Model K-2, it works well for close-talking purposes, since it is not overloaded accoustically. This type is a product of Astatic Microphone Laboratory, Inc., Youngstown, Ohio.

Another new type of construction is employed in Shure Brothers new "Spheroid" non-directional high-output microphone. The microphone is of the single-diaphragm type, horizontally mounted, contained in a sphere $2\frac{1}{4}$ inches in diameter. Sound actuates the diaphragm through a horizontal annular slot; because of this symmetry of construction, pick-up is uniform in all directions. This non-directivity aids the frequency response, as well, since all frequencies impinge upon the diaphragm on the same plane. The crystal itself is a new development of the Brush people, called the "Gra-foil Bimorph," cantilever supported and driven by a small shaped dural diaphragm. The various features of the design—"stream-lined"

Newark's

★★★ SPECIALS FOR AMATEURS IN THE UNITED STATES

Our new program available to all Amateurs. Deferred payments on receivers. SPECIALS at unheard of prices. NEWARK'S guarantee on all merchandise listed below.

	Cash Price	Time Price 6 Months	Time Price 10 Months	Down Payment	6 Months Payments	10 Months Payments
★★★ NATIONAL HRO — less power supply and speaker	\$167.70	\$175.34	\$177.90	\$37.70	\$22.94	\$14.02
★★★ NATIONAL HRO — with power supply, less speaker	\$183.60	\$191.44	\$194.30	\$43.60	\$24.64	\$15.07
★★★ NEW SUPER SKYRIDER — less crystal — Model S9	\$79.50	\$86.10	\$87.90	\$19.50	\$11.10	\$6.84
★★★ NEW SUPER SKYRIDER — with crystal — Model SX9	\$89.50	\$96.30	\$98.10	\$19.50	\$12.80	\$7.86
★★★ RCA — ACR — 136	\$69.50	\$75.90	\$77.40	\$19.50	\$9.40	\$5.79

Time payment plan on other receivers on request. Send your down payment with your order. Set is shipped as soon as credit is OK'd. Entire transaction approximately one week!

- ★★★ THORDARSON No. T6878 Plate and Fil. Transformer. 600-0-600 V. at 200 M. A. 2½ V. at 10 amp., 5 V. at 3 amp., 7½ V. at 3 amp.\$2.45
- ★★★ THORDARSON No. T6877 Heavy Duty choke. 15 henries at 250 M. A.\$1.95
- ★★★ THORDARSON No. T1998B Choke. 18 henries at 200 M. A. 190 Ohms — 2200 Volt insulation.\$1.25
- ★★★ NEWARK PAPER FILTER CONDENSERS
 - 1 mfd. 1000 V. DC.56c
 - 1 mfd. 1500 V. DC.66c
- ★★★ WELL-KNOWN PYROHM (Vitreous Enamel) RESISTORS. A lucky buy passed on to you through our ★★★ Special Program.
 - ★★★ NEWARK Oil filled — Oil impregnated Filter Condensers
 - 2 mfd. 2000 V. DC.\$1.50
 - 4 mfd. 2000 V. DC.\$2.25
 - 8 mfd. 2000 V. DC.\$2.75
 - 9 mfd. 3000 V. DC.\$7.25
 - ★★★ NEW LOW PRICES ON RCA TUBES
 - 852.\$16.40
 - 866.\$2.25
 - ★★★ Fiber Tubular Condensers with mounting feet
 - .1 200V. DC.07c
 - .1 400V. DC.09c
 - .1 600V. DC.15c
 - .1 800V. DC.20c

Type 991 7-Watt Ohms.	Type 992 15-Watt Ohms.	Type 992 con't Ohms.	Type 993 24-Watt Ohms.	Type 996-4 60-Watt Ohms.	Type 996-5 75-Watt Ohms.	Type 999 300-Watt Ohms	Type 994 32-Watt Ohms.	Type 998 200-Watt Ohms.	Type 996 100-Watt Ohms.
1	2	1100	100	20	20	1000	10	10	5
4	2.5	1200	150	100	20	2000	15	40	30
5	3	1250	200	250	100	3000	16	50	40
6	4	1350	225	300	175	5000	20	90	50
7	4.5	1400	250	315	350	7000	30	100	60
8	5	1500	400	500	500	10,000	100	250	100
9	5.5	1750	500	850	700	15,000	200	500	200
10	8	1800	600	1300	1300	20,000	250	1300	250
12	20	1850	1000	1500	1500	25,000	350	2000	500
25	50	2000	2000	2000	2000	40,000	550	2500	750
40	60	2200	2500	2250	3000	50,000	700	5000	800
50	75	2400	3500	2500	4000	60,000	750	6000	850
70	100	2750	5000	3000	5000	75,000	1000	7000	1000
75	150	3000	5500	4000	5900	100,000	1500	7500	1200
110	200	3250	8000	6000	6000		1750	10,000	2000
150	250	3500	12,000	7000	10,000	94c	2000	12,000	2500
200	375	3750	25,000	8000	12,000		3000	15,000	3000
300	450	4000	60,000	9000	20,000		3500	20,000	3800
400	500	5000		10,000	25,000		4000	25,000	5000
600	600	5500	20c	11,500	30,000		4500	30,000	6000
750	650	6000		12,000			5000	40,000	7000
800	700	6500		17,500	50c		7300	50,000	7500
900	800	7000		18,000			8000	60,000	8000
1500	850	12,500		20,000			8500	70,000	10,000
1750	900	15,000		30,000			9000	75,000	12,000
2000	1000	18,200					10,000	80,000	15,000
							12,000	100,000	17,500
							17,500		20,000
							20,000		25,000
							22,500		30,000
							30,000		35,000
							35,000		50,000
							40,000		60,000
								25c	60c

New Low Prices on United Transmitting Tubes

Type	New Price
966 Mercury Rectifier.	\$ 2.25
952 R.F. Amp. & Osc.	16.45
972 Mercury Rectifier.	15.00
972A Mercury Rectifier (shielded).	16.50
945 Audio Amp.-Modulator.	17.50
303A R.F. Amp., Osc. Class B Mod.	15.00

All Resistors new and individually boxed

YOU MAY DEDUCT ADDITIONAL 10% ON RESISTORS ONLY IN LOTS OF TEN OR MORE ASSORTED

There is a limited amount of the above specials listed and would suggest ordering at once. Orders will be filled in order received

No C.O.D. orders accepted for less than \$1.00. Include postage with orders

Newark Electric Company

"FASTER SERVICE—BETTER BARGAINS"

226 W. Madison Street

Dept. Q

Chicago, Illinois

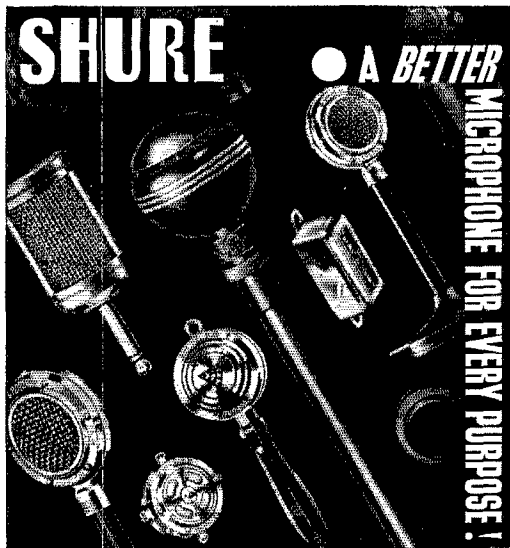

● Whether it be for General-Purpose use or Specialized Applications . . . you will find in the Complete *SHURE Line the microphone that will best fit your exact needs. What better proof of performance than the fact that they have been adopted by 35 leading Sound-Equipment Manufacturers — used in thousands of sound and broadcast installations throughout the world!

*The complete SHURE line contains more than 100 Crystal, Carbon, Condenser Microphones, Stands and Unit Accessories — Complete Microphone Equipment for every Microphone Application! Crystal Microphones licensed under patents of the Brush Development Company.

For detailed information on any item, ask your Jobber . . . or write!

SHURE BROTHERS COMPANY
 Manufacturers of Microphones Headquarters Cable Address SHUREMICRO
 CHICAGO, U. S. A.
 215 WEST HURON ST.

BIRNBACH
 Transmitter
 LEAD-IN
 INSULATOR

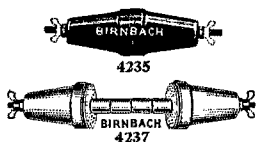

LIST PRICES

10" rod for 4" wall, \$.90
 15" rod for 9" wall, \$1.00
 10" rod and bushings for 4" wall . . . \$1.20
 15" rod and bushings for 9" wall . . . \$1.50

Porcelain bushings, 3/8" dia., 1/4", 1/2" or 1" long . . . 5c each

BIRNBACH RADIO CO., Inc. Write Dept. Q-12 for Complete Data
 145 HUDSON STREET NEW YORK CITY

form, carefully-proportioned slots, damping surfaces and apertures, low internal capacity with reduced cable losses, high-output crystal with cantilever connection, and the horizontal diaphragm—contribute to the extremely high output, —55 db, and the good frequency characteristic, flat within 5 db from 40 to 10,000 cycles. A three-conductor cable is provided, the microphone itself being fitted with a three-pin plug enabling ready connection to or removal from the mounting stand.

—C. B. D.

Mrs. Isabelle W. Moody, W7DHF

UNHAPPY as was the passing of Mrs. A. Skene (Isabelle W.) Moody, 47, well-known, well-respected, and well-beloved operator of W7DHF, on October 3rd, her death was doubly sad in view of its cause: electrocution while operating her amateur radio station. A licensed operator for about two years, she had first garnered radio knowledge and passed the federal examination in order that she might communicate with her two sons, Alfred, W7AOF, who is attending the University of California, and William, W2HVI, an employee of General Electric in New York City. Her activity on the air was not limited to these contacts, however, and she became well known to 20-meter operators throughout the world, maintaining many schedules with the east coast and Canada. She was an ardent enthusiast, sometimes remaining at the operating table from 6:30 a.m. to 11:00 p.m., having her meals served in the room. The fatal accident occurred after a QSO with VE2FQ, on c.w. While changing the transmitter over to 'phone, a deed accomplished by clipping the 3200-volt plate lead around the Class B transformer, she neglected to turn off the high voltage. With this clip in her hand, her leg touched the transmitter frame, and she was evidently immediately electrocuted.

Mrs. Moody was a prominent citizen of Portland, Ore., and received impressive tributes by newspapers and others at her death. She had been identified with numerous civic projects, notably Community Chest work, and was a member of the Town Club and a director in the Girl Scouts. Her tragic death should prove an impressive warning to all amateurs that the equipment employed in their hobby possesses fatal potentialities, not to be lightly regarded or handled without full care.



HAVE YOU SEEN THE

NEW

TWICE AS BIG HANDBOOK?

480 *PAGES*

*Over 500 Diagrams, Charts and
Photographic Illustrations*

Get Your Copy!

\$1

POSTPAID

IN U. S. A. and POSSESSIONS

*Elsewhere, 15c additional to
cover postage*



Buckram Bound • \$2.50

American Radio Relay League, Inc.

WEST HARTFORD . . .
. . . CONNECTICUT



Revolutionary!

THE MICROPHONE OF Tomorrow HERE TO-DAY

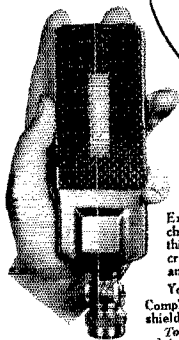

The new BRUNO SK-2 velocity microphone is a decided advancement in microphone design. Exceptional quality characteristics makes this guaranteed microphone an asset to any transmitter station.

Your cost \$17.10 net. Complete with six feet of shielded cable.

To-day—write for detailed descriptive catalog material!



WILLIAM BRUNO
Founder and President
of Laboratories

BRUNO

LABORATORIES
20-22 West 22nd Street
NEW YORK, N. Y.

A GOOD R. F. ANTENNA METER FOR \$3.57 (HOT WIRE TYPE)

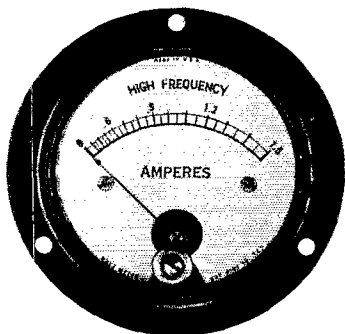

The New Hoyt Hot Wire Ammeter for transmitter output is receiving enthusiastic endorsement by amateurs everywhere. Comes in flush mounting bakelite cases and is unaffected by frequency changes. Ranges furnished: 0/1.5; 0/3; 0/5 amps. Price only \$3.57.

Available also is a complete line of panel mounting Milliammeters, Ammeters, Voltmeters — D.C. and A.C., High Resistance D.C., Voltmeters, and Pocket Battery Testers in all popular ranges.

BURTON-ROGERS COMPANY

Sales Division of Hoyt Electrical Instrument Works
755 Boylston Street, Boston, Mass.

Self-Regulating Grid-Bias Supply

(Continued from page 24)

If Class-B stages must also be biased, the same voltage supply may also be used for this purpose. The difference in the design for the Class-B stage lies in the fact that the bias must remain very nearly constant and at such a value as to cut off (or nearly cut off) the Class-B stage plate current when no excitation is applied. This necessitates that the bias supply shall deliver a slightly higher voltage than that required to cause cut-off in the Class-B stage. For the Class-B stage, however, the required bias is only about half of that required for a Class-C stage, so that the same bias

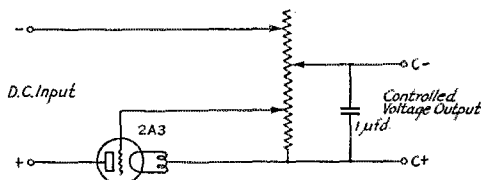

FIG. 2.—TRIODE SERIES REGULATOR FOR CLOSE CONTROL OF CLASS-B AMPLIFIER BIAS

As the grid of the regulator tube becomes more negative with respect to its filament, its series plate-filament resistance rises and holds down the output voltage.

potential supply will usually suffice for both types.

To gain the required constancy of bias for amateur transmitter Class-B stages, the resistance R required may be calculated as before and then divided by about five. The voltage should then be set by the position of the supply tap, as before, except that the bias should not be raised above the plate current cut-off point.

If greater constancy for the bias of the Class-B stage is desired, its "valve action" diode may be changed to a triode of a low plate-resistance type, as shown in Fig. 2. The triode must be able to carry the current drawn by the resistor. If one triode (such as a '45 or '50 or 2A3) will not handle the current, several of them in parallel will do the work.

The current is

$$I = \frac{E}{R}$$

where E = the supply voltage and R = the value of resistance between the supply tap and $C+$.

It will be noted that the triode must be connected in the positive lead; therefore, if more than one stage is to be biased by the same supply, either all must be operated from the same triode regulator and voltage divider; or, if separate triode regulators are used, the amplifier filament circuits must be entirely separate and ungrounded.

From this it may be easily seen that the diode method gives the more simple and fool-proof system of the two. It will supply controlled and protective bias for Class-C stages and nearly fixed bias for Class-B stages, without interaction between the bias acting on the various amplifiers; and only one rectifier-filter circuit is needed.

FOR BETTER RADIO

USE

Hammarlund

I.F. TRANSFORMERS

AIR-TUNED • VARIABLE COUPLING

- 1 CONTINUOUS VARIATION OF BAND WIDTH — EXTREME SELECTIVITY TO HIGH FIDELITY
- 2 PANEL OR INDIVIDUAL CONTROL — POSITIVE COIL SPRING ACTION
- 3 IMPREGNATED THREE PIE LITZ COILS • ISOLANTITE CORES — HIGH GAIN
- 4 FOR ANY I.F. AMPLIFIER WITH SCREEN GRID TUBES — 175 AND 465 KC TYPES
- 5 ONLY 2" x 2" x 5"
- 6 GUARANTEED STABILITY

WRITE DEPT. Q-12 FOR
GENERAL CATALOG

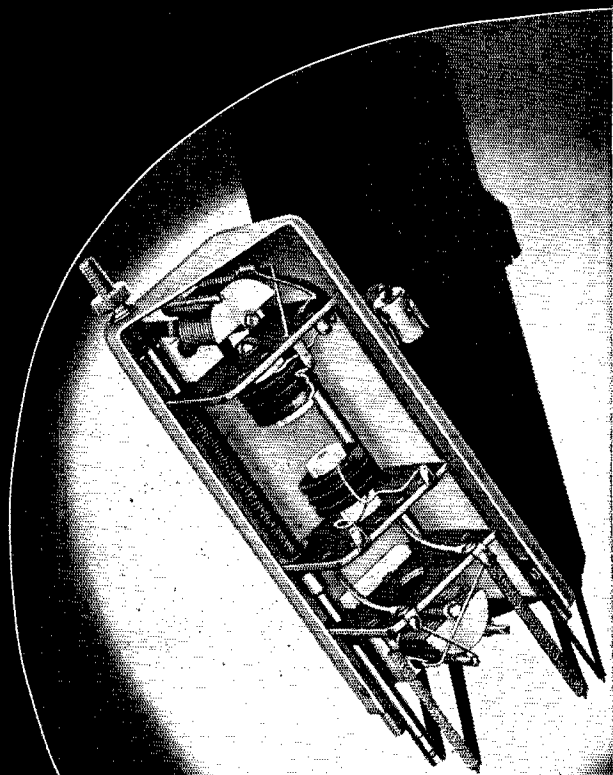

HAMMARLUND MANUFACTURING CO.

424.438 West 33rd Street, New York

CANADIAN OFFICE: 41 WEST AVENUE NORTH, HAMILTON, ONTARIO

Say You Saw It in *QST* — It Identifies You and Helps *QST*

Yours for

\$7.50

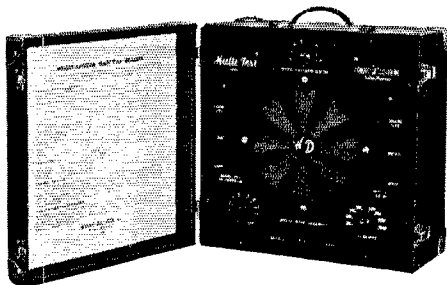

Ask your distributor how you can own the

WRIGHT-DECOSTER "Multi-Test" Speaker

For only \$7.50

Every Sound Engineer, Service Man, Amateur and Experimenter needs this "Multi-Test" Speaker.

WRIGHT-DECOSTER 5" Dynamic Speakers \$3.90 RETAIL FOR ONLY

"It costs no more to use WRIGHT-DECOSTER"
Write for complete details, specifications, prices

WRIGHT-DECOSTER, INC.

2259 University Avenue St. Paul, Minnesota
Export Dept. M. Simons & Son Co.
Cable address: SIMONTRICE, New York

16th Pacific Division Convention

WITH a blare of trumpets (or was it horns?), the 1935 Pacific Division Convention burst into being at 10:30 a.m., August 31st. Before the final registration of the 878th person had taken place, there were VE4's, W4's, W5's, K6's, W7's and W9's among those present, making one of the largest out-of-the-district attendances in addition to the largest divisional convention ever held on the Pacific Coast.

The Hotel Biltmore in Los Angeles had offered its full facilities, which, as the hours passed and the number grew, were vitally necessary for the comfort and pleasure of the many convention-minded hams and their friends.

When the convention was officially called to order by Convention Chairman Charles M. Feay, words of welcome were expressed on behalf of the City of Los Angeles by Mr. F. T. Hawtrey, Inspector in Charge of Communications for the Los Angeles Police Department; and for the Federation of Radio Clubs of the Southwest by General Chairman Phil Snyder.

The first item on the program was a trip to the Acme Brewery, where over 400 hams and their (x)YL's enjoyed all the samples of the famous brew they could drink. After a sufficient lapse of time, the technical session was opened by Mr. William W. L. Burnett who spoke on the subject "Crystallography," followed by Mr. J. A. McCullough on "Power Performance of Class 'B' and 'C' Amplifiers" and Mr. Frank C. Jones on "The Exciter."

In the early evening, the Army and Navy System's dinners were the next order of the day. Following, the looked-for Frolic, with Nick Harris, the well-known detective, as M.C., was well-attended and enjoyed by all. Perhaps the many prizes that were won by the lucky ones helped to bring that spirit of wonderful geniality into evidence. After the Frolic, at the ghostly hour of midnight, the poor unsuspecting brothers who dared were initiated into the Royal Order of the Wouff Hong. Some lived through it; however, some of those who did will never be the same.

Sunday morning started with a group of meetings covering all phases of ham radio: u.h.f., DX, traffic, c.w. and 'phone. At 10:00 a.m. everybody piled into busses or their own cars and headed for the RCA-Victor Recording Studios in Hollywood where for three hours the gang was entertained royally by RCA who even provided an FB lunch!

The balance of the afternoon was devoted to contests and the Open Forum where resolutions were passed calling for the referring to the Investigating Committee of certain matters; requesting the Board of Directors to ask the F.C.C. to show more leniency toward offenders of certain types after a year has passed since the offense; expressing approval of a petition to Congress. As the time was approaching for the main event of the convention, the banquet and the prize drawing, the Open Forum was adjourned until the following morning.

At 7:30 p.m. everybody gathered in the huge Ballroom of the Hotel Biltmore for the banquet;

TED McELROY
World's Official
Champion Radio
Operator.
Speed 69wpm.



LEARN CODE RIGHT OR INCREASE YOUR SPEED

With the System that Made Champions
of Jean Hudson and Ted McElroy

CHAMPION McELROY says: "My speed is the result of CANDLER trainings. It taught me to read code as easily as I read print, and to copy by touch on my "mill" at high speeds. Beginners who wish to learn code right; amateurs and com' ops who want real speed, will save themselves much time and discouragement by taking THE CANDLER SYSTEM."

FREE — BOOK OF FACTS For Beginners and Ops, also McElroy's article: "How I Learned to Handle Code." A card will do. No obligation. Your Government License Guaranteed.

CANDLER SYSTEM CO.
Dept. Q-12 Box 331 Asheville, N. C.

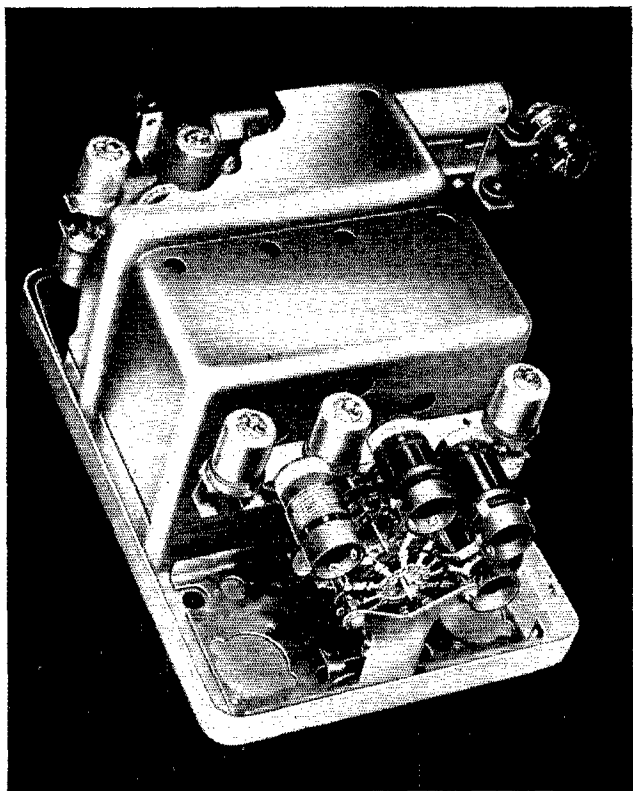

A cut-away view of the underside of SENTRY BOX showing coil mountings and PERMALINERS. Note the clean wiring and short, rigid leads.

The SENTRY BOX unit includes the tuning condenser and dial mechanism as well as the coils and switch compartments. Separate coils are used for each circuit and no tapped coils are used. Careful design permits shortest possible leads — coils are mounted directly on their respective band change switches. Separate shielded compartments shield the R.F., detector input and oscillator circuits. The result is efficiency and stability of performance heretofore impossible of attainment. Permanence of circuit alignment is assured by the use of the PERMALINER trimmer capacitor — a new air-dielectric trimmer, sealed against moisture and dirt.

**GENERAL
ELECTRIC
SENTRY
BOX
CONTROL**

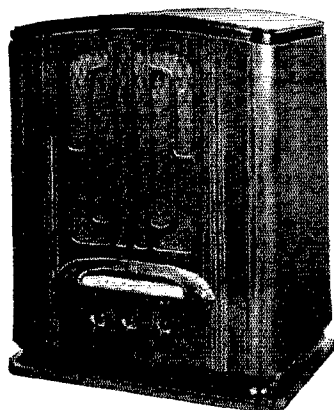

MODEL A-82. A production broadcast receiver, yet built like a commercial communications instrument. Eight Metal Tubes • Four Reception Bands • Sentry Box • Permaliners • Stabilized Dynamic Speaker • Sliding-rule Tuning Scale • Noise Control • Lo-note Compensation • CW Oscillator may be added.

\$94.50
(Eastern List Price)

GENERAL  ELECTRIC
RADIO

MERCHANDISE DEPARTMENT, GENERAL ELECTRIC COMPANY, BRIDGEPORT, CONNECTICUT



Mr. E. H. Rietzke, President of CREI and originator of the first thorough course in Practical Radio Engineering.

PRACTICAL RADIO ENGINEERING

... is the "shortest cut" to success!

There's a definite reason why many men quickly get ahead in Radio ... while others remain at routine jobs and wonder why! Radio is becoming more and more specialized and intricate ... it demands men with TECHNICAL TRAINING. CREI offers you a definite future by giving you the "tools to build it!"

CREI Training for Every Man

New 48 Page CATALOG
Illustrates and fully describes all courses. Write for your free copy today!

Our courses are written for the man **ALREADY** in Radio — in his own language. The CREI home study courses in Radio Engineering and Service Engineering are planned to meet your personal needs. We shall be glad to answer your inquiries, and suggest the proper course of study.

CAPITOL RADIO ENGINEERING INSTITUTE

14th and Park Road, N. W. Dept. Q-12
WASHINGTON, D. C.



Director S. G. Culver with his customary smile acting as Toastmaster. Short talks were given by Mr. Bernard H. Linden, Inspector in Charge, 11th Radio Inspection District and Mr. Frank "Around-the-World" Andrews of Station KFL. Several prominent persons in the radio field were also introduced. Following the dinner, 140 prizes were distributed to the holders of the lucky tickets.

Monday morning program began with the continuation of the Open Forum where further resolutions were passed calling upon the Board of Directors to move Headquarters to a more central location; and to publish the report of the Investigating Committee. Considerable discussion of the 5-meter bootleg problem also resulted in a better understanding of the situation on that band.

In the afternoon technical session Mr. Wm. L. Comyns developed the subject of "Controlled Carrier Modulation," Mr. J. N. A. Hawkins spoke on "The R. F. Amplifier" and Mr. Ralph O. Gordon told about his "5-Meter Super." Following the technical meeting, visits were in order to the Los Angeles Police Radio Station KGPL, Station KHJ, a newspaper plant, a transformer works and the world-famous Planetarium. Everyone reported having a glorious time at the convention.

Impressions: The large number of ladies attending (over 130) ... the absence of Don Wallace's high-power motion ... the ladies stating that they were really enjoying themselves ... the frenzied effort to keep up with the full program ... the free gasoline for those who drove their cars to Hollywood ... the two new hams who tried to hold two steins of beer apiece while they tried to pick up a pretzel ... the blackness prevailing in the Wouff-Hong initiation ... the rush to get a good spot in the Convention picture ... pasting convention stickers all over the busses ... the Biltmore Lounge, which almost "drank itself dry" ... those hats provided by two of the local jobbers! ... "Geel! Look at the prizes!" ... "Sorry, OM, I won't have time to take in the technical meeting. I have to meet that guy I worked last year." ... "Say, have any of you fellows seen my wife?" ... "You come up to my room after this." ... those whistles and the inevitable napkins ... the Southwestern gang really proud and happy to show the whole Pacific Division bunch a good time, it being the last opportunity to do so. On, Pacific and Southwestern Divisions, together!

—W6EQM

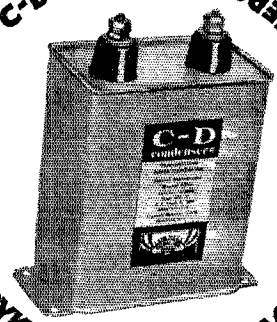

C-D
DYKANOL HIGH VOLTAGE X-MITTING CONDENSERS

To quote thousands of hams—the country over:
"DYKANOL—the Cornell-Dubilier oil-impregnated and oil-filled, non-inflammable, hermetically sealed x-mitting condenser stands for **DEPENDABILITY, SERVICE, PRICE!**"

DEPENDABILITY—because of tremendous manufacturing facilities.
SERVICE—because of prompt deliveries of the most exacting requirements.
PRICES—exceptionally low because of quantity production, resulting from tremendous demand.
C-D Dykanol x-mitting condensers are within the reach of the most limited budget! Unconditionally guaranteed. Available at all C-D distributors!

P.S.—have you a copy of our latest catalog? They are free—get one today!

CORNELL-DUBILIER

CORPORATION

4373 BRONX BOULEVARD
NEW YORK

13th Annual Central Division Convention

THE first day of the Central Division Convention held at the Hotel Statler, Cleveland, August 30th-31st, opened with about 195 registered. The weather was very bad—cold and rainy. This



Be Santa Claus to Your Friends Complete the Circle with 1936 Copies

QST can help you with your Christmas list. Each year an increasing number of individuals finds it to be *the* ideal gift. A subscription present is unique, too. It serves as a monthly reminder of your thoughtfulness. A yearly subscription, including League membership, costs only \$2.50, little enough for the ones you have in mind. And — we'll send an appropriate gift-card conveying your Christmas Greetings at the proper time.

A MONTHLY REMINDER OF YOUR
THOUGHTFULNESS AND GOOD JUDGMENT

QST

38 La Salle Road . . . West Hartford, Connecticut

★ PEAK P-II REGENERATIVE HIGH-GAIN PRE-SELECTOR ★

Unsurpassed



The only successful regenerative pre-selector commercially built. It won its spurs on these salient points: —

- 1 — Tremendous increase in signal strength.
- 2 — Consequent increase in sensitivity.
- 3 — Absolute rejection of image.
- 4 — Considerable increase in selectivity.
- 5 — Decrease of noise to signal ratio.

● Two tuned stages ● Wave length 14-200 meters ● Rapid band changing ● No plug-in coils ● Self contained heater supply ● Smooth electron coupled regeneration.

P-II is in use throughout the world! It certainly merits your attention. Your cost \$19.80 net. less tubes.

PEAK Q — 5 ULTRA HIGH FREQUENCY SUPER-HETERODYNE RECEIVER: 2 1/2-5 and 10 meter.

The Peak Q-5 super-het receiver is a high gain, ultra high frequency unit for 2 1/2, 5 and 10 meters. The Q-5 has undergone numerous tests and comes to you as the finest receiver in its class. In operation the Q-5 has the selectivity and sensitivity of the super-het, but lacks the "hiss" found so objectionable in super-regenerative receivers. It gives real superheterodyne performance. Your cost \$21.60.

PEAK

EASTERN RADIO SPECIALTY CO.

1845 BROADWAY **PRODUCTS** NEW YORK, N. Y.



Americans are proud of the industrial achievements that have made their brawn, courage and ingenuity world famous. The chief disease which threatens that supremacy is tuberculosis. It is the greatest cause of death between the ages of 15 and 45. Help protect American man power from this enemy by purchasing the Christmas Seals that fight it all year round. The seals you buy today may save your life tomorrow.



BUY CHRISTMAS SEALS

The National, State and Local Tuberculosis Associations of the United States

didn't hurt the convention so much but was a disappointment to the National Air Races held at the same time. Approximately 30 amateurs were also active at the National Air Races.

The first day, Friday, was taken up with trips. During the afternoon and in the evening the U. S. Coast Guard supplied and ran off several reels of a new movie which were very interesting. Following this Director Roberts showed his convention movies and the Hq film. The balance of the evening was taken up with an "open discussion" period, with all those in attendance taking part. The meeting finally broke up into several small meetings and very few got much sleep that night.

Saturday morning featured the regular meetings, SCM's, A.A.R.S., ORS, U.S.N.R., DX, c.w., 'phone, etc. All were well attended. A Central Division 'phone organization was formed at this convention during the 'phone meeting with Adam Moranty, W8CZT, president, Harold Abel, W8FHE, vice-president and George Fagerholm, W8LXV, secretary-treasurer. At the afternoon session our guest speakers were John Reinartz from RCA, C. B. Scott of Brush Laboratories, B. H. Short of Purdue University, Henry Argento of Raytheon Production Corp., Larry Geno, W8PE, of Buffalo, N. Y., Mr. Cole of General Transformer Co., Roy Corderman, W3ZD, of Washington, R. T. Pennebaker of Bud Radio, Inc., Lieut. H. S. Scott of the U.S.N.R. and Roy Corderman of the A.A.R.S. At 6 p.m. the Royal Order of the Wouff Hong was put on by the Cleveland Electrical Illuminating Co.'s Radio Club. Immediately after this, Director Roberts spoke over the NBC radio station, WGAR, in a half-hour address on amateur radio.

A few minutes out before dinner and then the grand banquet. Total registered at this time was 347 and everyone agrees that the meal served was one of the best ever. As president of the sponsoring club, N8BAH opened the banquet and introduced members of the committee, then turning the banquet over to Prof. J. R. Martin of Case School who was toastmaster. Director Roberts was the first speaker, followed by Director Bailey, Director Hill, Alternate Director Wathen, Dr. Simpson, and Thorne Donnelly, W9PZ. Prizes were then given out and a dance followed.

The only way the Committee on any convention can know whether the convention was successful or not is by the expressions from those attending. Everyone said they had a good time, and that was enough for us.

—N8BAH

Roanoke Division Convention

ON THE 5th and 6th of October, the Charlotte Amateur Radio Association, Inc., sponsored the annual convention of the Roanoke Division, with headquarters in the Hotel Charlotte. Saturday morning saw a buzz of activity in and around the hotel. Registration began at 8 a.m. and by the opening of the convention at one o'clock approximately two hundred names were on the register. The convention was officially

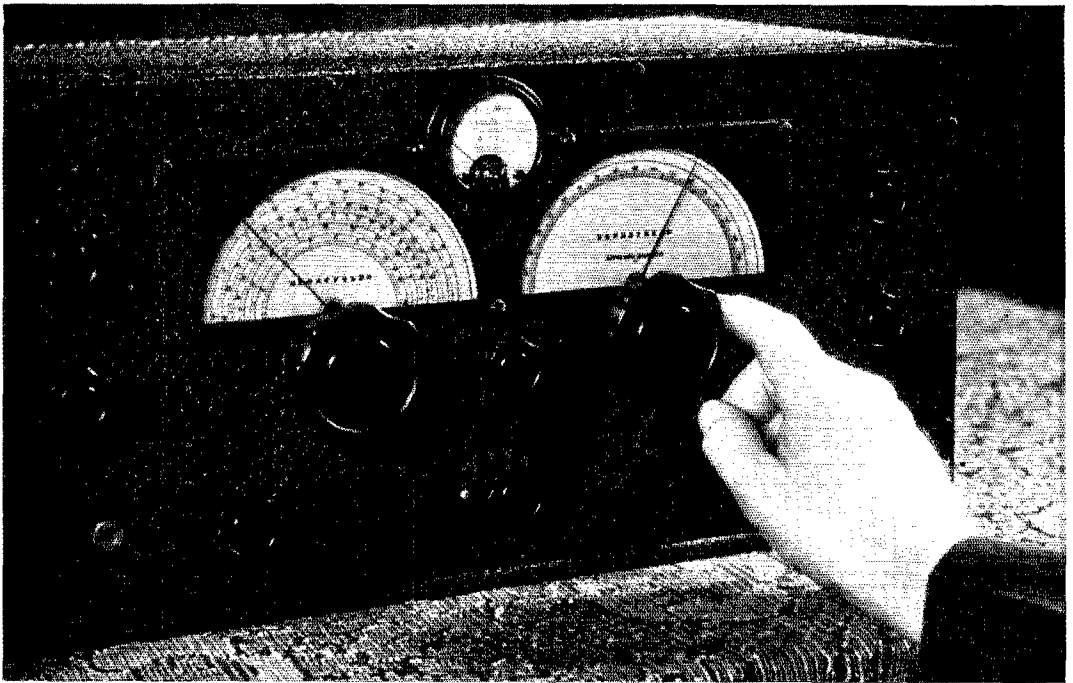

THE NEW RME-69 SSS RECEIVER

FINGER-TIP CONTROL!

Two large five-inch dials, operated with exceptional ease and smoothness, constitute the tuning mechanism of the 69.

The *left hand dial* is calibrated in megacycles covering a continuous range of frequencies, beginning at 550 kilocycles and going through the ten meter amateur band. This range is divided into six band scales, selection being made with the lower center knob on the front panel.

The *right hand dial* affords the very essential electrical bandsread over an arbitrary range of frequencies chosen by the operator. The adjustment ratio is ample, even for ten meter reception using the series crystal filter. The large knobs aid materially in the tuning process and naturally add to the general appearance.

The R-meter is in the circuit at all times, reading the variations in signal strength of the incoming carrier. It gives a continuous minute to minute check on your communication signal. The meter is calibrated in decibels as well as in arbitrary R-1 to 9 values.

Despite its simple operation this instrument has an exceptional degree of flexibility. The variable audio beat control, the monitor send-recvie control, the variable resonator adjustment for automatic peaking of the receiver, — everything built into the RME-69 will completely satisfy your ambition to own one.

ASHEVILLE, N. C. Bridgewater Radio Service Co., 141 White Fawn Dr.
 BUFFALO, N. Y. Dymac Radio Company, 216 East Genesee St.
 BUTLER, MISSOURI. Henry Radio Shop, 211-215 North Main St.
 CHICAGO, ILLINOIS. Chicago Radio Apparatus Co., 415 S. Dearborn St.
 CHICAGO, ILLINOIS. Green Mill Radio Shop, 145 West 111th St.
 CHICAGO, ILLINOIS. Newark Electric Company, 226 West Madison St.
 CINCINNATI, OHIO. Krauss Radio Stores Inc., 111 East Fifth St.
 DENVER, COLO. Inter-State Radio & Supply Company, 1639 Tremont St.
 DETROIT, MICH. Radio Specialties Company, 171 E. Jefferson Ave.
 DULUTH, MINNESOTA. Palmer's Trading Post, Route One
 FLINT, MICHIGAN. Wilke & Sessions, 711 1/2 West Dayton St.
 HELENA, MONTANA. W. A. Robinson, P. O. Box 413
 INDIANAPOLIS, INDIANA. Van Sickle Radio Shop, 34 West Ohio St.
 KANSAS CITY, MISSOURI. Radio Laboratories, 1515 Grand Ave.
 MINNEAPOLIS, MINNESOTA. Law Bonn Company, 1124-26 Harmon Place

NEW ORLEANS, LA. Christy Radio Laboratories, 3501 Prytanis St.
 NEW YORK, NEW YORK. Gross Radio, 51 Vesey St.
 NEW YORK, NEW YORK. Harvey's Radio Shop, 103 West 43rd St.
 OKLAHOMA CITY, OKLA. Southern Sales Company, 130 West 3rd St.
 OMAHA, NEBRASKA. Radio Accessories Company, 2855 Farnam St.
 PEORIA, ILLINOIS. Radio Mfg. Engineers Inc., 306 First Ave.
 PORTLAND, OREGON. Wedel Company Inc., 1207 S. W. Washington
 RICHMOND HILL, N. Y. Marine Radio Company, 124-11-101st Ave.
 SACRAMENTO, CALIFORNIA. Henderson Brothers, 1501-45 K St.
 SPRINGFIELD, ILLINOIS. Bruce Company, Monroes near Second
 TERRE HAUTE, INDIANA. Hulman and Company
 TEXARKANA, ARKANSAS. Mims Radio Shop, Box 504
 TOLEDO, OHIO. Aitken Radio Corp., 1014 Madison Ave.
 TULSA, OKLAHOMA. Radio Inc., 219 South Boulder
 WILMINGTON, DEL. Wilmington Elec. Specialty Company, 485 Del. Ave.

See your dealer for a demonstration, or write us for Bulletin No. 69
 containing complete information

RADIO MFG. ENGINEERS INC., 306 First Ave., PEORIA, ILL.

EIMAC

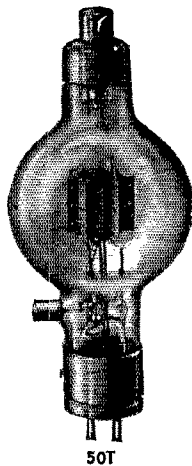

50T

A TRULY
"GREAT" TUBE
WITH STILL
GREATER
CAPABILITIES

New Ratings
EIMAC 50T

Fil. Volt. 5-5.25
Max. Plate Cur. 125 MA
Max. Plate Volts 3000
Plate Dissipation 75 Watts

Price \$13.50

At leading dealers

EITEL-McCULLOUGH, INC.
SAN BRUNO, CALIF.



"HAM" SPECIAL Standard
Teleplex

A highly efficient code teacher using heavy specially prepared waxed paper tape, having two rows of perforations. Write for Free folder Q.T. DEALERS — Correspondence invited with dealers for protected territories.

We are the originators of this type instrument
TELEPLEX CO.

76 Cortlandt St., New York City

Instrument with tapes prepared by expert and complete course of lessons; all for \$11.95

MEMORANDUM

- ✓ You need a copy of the new twice-as-big 1936 Handbook.
- ✓ You need a binder for your 1935 *QST*'s — and another for 1936.
- ✓ Xmas suggestion — give a membership subscription or a new Handbook.

DECEMBER, 1935

opened by E. P. Mallard, W4CXC, president of the Charlotte Amateur Radio Association who introduced Mr. Charles Drury, W4BFB, the master of ceremonies. Mr. Drury in turn presented the Hon. Ben E. Douglas, Mayor of the City of Charlotte, who welcomed those present on behalf of the city. The first speaker was Dr. E. C. Woodruff of Pennsylvania State College, who gave an extremely interesting technical talk. The technical talks were interspersed with stunts, much to everyone's amusement. Next on the program was Mr. Roy C. Corderman who gave a talk on "Something New in Crystals." The speakers who followed and their subjects were Mr. G. H. Moore of the Duke Power Company, "A Circuit for the Suppression of Electrical Interference," and Mr. R. N. Eubank, chief engineer of WRVA, "A New Antenna Tower." The ladies attending the convention were excused at the beginning of the technical talks and enjoyed a theater party and other entertainment. At 5:30 the gang attended a Dutch supper and chewed the rag until seven o'clock at which time all assembled for an enjoyable session of League affairs and technical talks. Mr. K. B. Warner and Mr. A. A. Hebert were eagerly received by the gang and gave everyone the information they desired about the League. Mr. John L. Reinartz, of R.C.A., held the attention of the gang so well with his subject that when the dance started at 9:00 p.m. a bunch of the fellows skipped the dance in order to continue with Mr. Reinartz in another room. Dancing and an elaborate floor show held sway until midnight, at which time a number of League members were initiated into the Royal Order of the Wouff Hong.

Sunday morning the meetings of the A.A.R.S. and the N.C.R. held its members' attention, while non-members visited local broadcast and ham stations. The ladies were taken on an interesting sight-seeing trip and entertained with a unique doll show. At one o'clock Mr. H. L. Caveness, director of the division and master of ceremonies for the day, opened the banquet. Short talks from the speakers table were made by Messrs. John L. Reinartz, Roy C. Corderman, K. B. Warner, Dr. E. C. Woodruff, A. A. Hebert, R. N. Eubank, E. P. Mallard, Gordon S. Smith, E. J. Gluck, H. S. Carter, and Bannie L. Stewart. The following resolution was presented by Mr. E. J. Gluck and adopted unanimously by the assembly:

"WHEREAS, this Roanoke Division Convention of the A.R.R.L., now in session represents the amateur personnel of the division and

"WHEREAS, there has been some criticism of the officers and directors of the League and their policies,

"Therefore, this convention hereby resolves the following:

"We believe in the officers and directors of the League and believe them to be sincere and capable in its direction.

"We pledge to them our united support and confidence.

"We further request that this resolution be presented to the officers and directors of the League and that it be made public through the League publication, *QST*."

Due to the fact this was the last Roanoke Division convention that Mr. Hebert would be able to attend, the Roanoke Division presented him with a token of their appreciation and esteem. The convention adjourned about five-

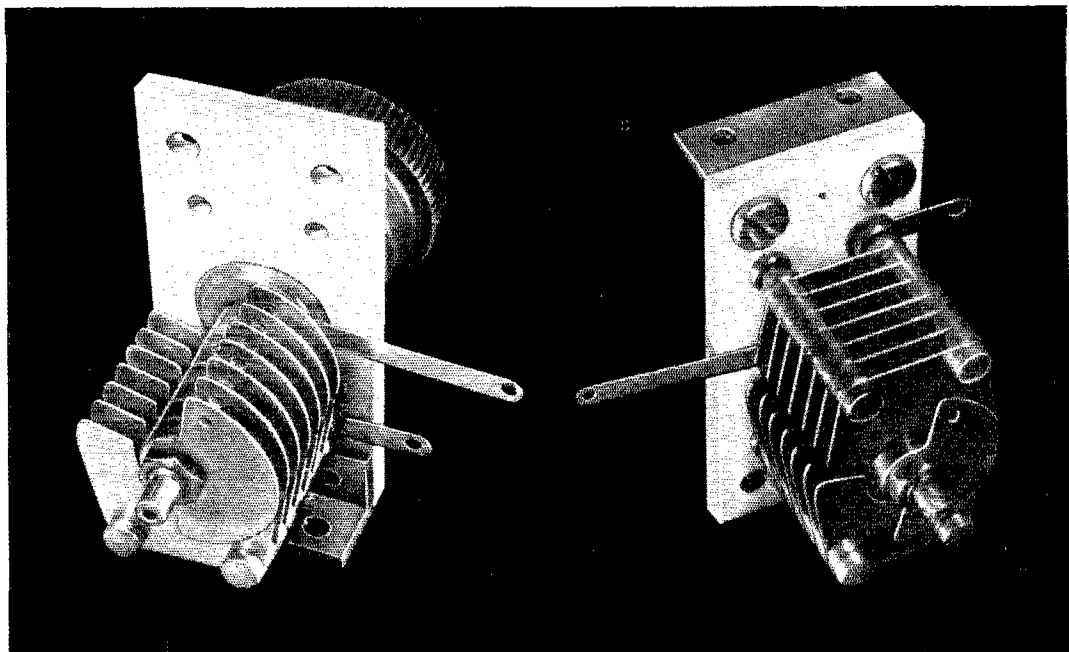

ULTRA MIDGET CONDENSERS

Ultra High Frequency, Ultra Small Size, Isolantite insulated, these new condensers are ideally suited for use in padding and neutralizing, and for tuning high frequency receivers. They are particularly suitable for Fixed-Tuned exciter stages of band-switching transmitters.

A balanced-stator model is also available, in which two stators act upon a single rotor. Connections are usually made to the two stators only, eliminating the rotor contact, shortening leads, and reducing minimum capacity. For ultra high frequency work these advantages often outweigh the disadvantage of having only ninety degree rotation.

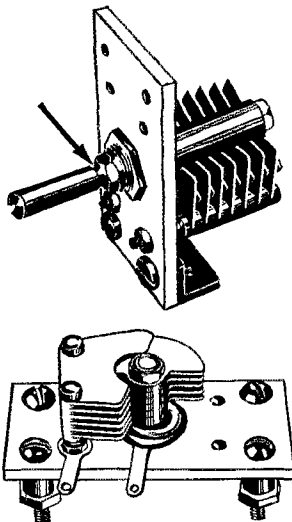

The small size of the new Isolantite Ultra Midget Condensers simplifies efficient layout and effective shielding. They can be mounted inside small coil-shield cans. The shaft extension is long enough for a conventional knob or dial, but may be readily cut off at the groove provided for this purpose. (See arrow at left.) A hexagon head is provided so that adjustments can be made with a socket wrench when the shaft is not used.

The new condensers can be mounted either by the angle foot shown above, or by spacers and bolts direct to the panel, as illustrated below.

Capacity	Symbol	Net Price	Capacity	Symbol	Net Price
Single-Spaced			Double-Spaced		
15	UM-15	\$.75	25	UMA-25	\$1.11
35	UM-35	.90			
50	UM-50	.96	Balanced Stator, Single-Spaced		
75	UM-75	1.02	25	UMB-25	1.11
100	UM-100	1.14			

NATIONAL CO., INC.  MALDEN, MASS.

Say You Saw It in QST — It Identifies You and Helps QST

TERMINALS

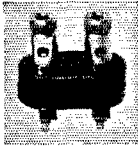

OFTEN in the construction of amateur and experimental equipment it is necessary to provide terminals on a metal panel.

General Radio Panel Terminal Insulators are designed for this use. They are self-centering and consist of two moulded bakelite insulators and two special jack-top binding posts with extra long studs.

These insulator assemblies are available in two models, Type 274-Y with black bakelite insulation and Type 274-Z with yellow (low-loss) bakelite.

They are priced, complete with two binding posts: Type 274-Y . . . 60 cents and Type 274-Z . . . 70 cents.

GENERAL RADIO

Cambridge

Massachusetts

More Distance • Less Noise



MILLER PRE-SELECTOR

J. W. MILLER COMPANY
5917 So. Main St. • Los Angeles, Calif

PATTERSON R-16

ALL WAVE RADIO

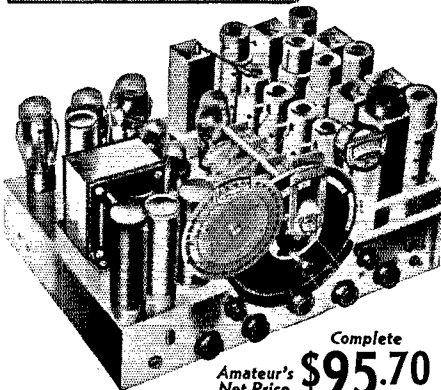

Complete
Amateur's
Net Price **\$95.70**

Engineered to fill every requirement of the professional operator, amateur, and experimenter. Complete with 16 matched tubes, 12-inch heavy duty, balanced speaker. Amateur's Net Price \$95.70. Write for descriptive circular.

PR16 with Crystal Complete \$101.70

M. & H. RADIO 512 Market Street
Philadelphia, Pa.

thirty with all in high spirits after the largest and best convention ever held in the Roanoke Division.

—W4BX

Standard Frequency Transmissions

Date	Schedule	Station	Date	Schedule	Station
Dec. 1	C	W6XK	Jan. 10	B	W9XAN
Dec. 6	A	W6XK		B	W6XK
Dec. 13	B	W9XAN	Jan. 15	C	W9XAN
	B	W6XK	Jan. 17	B	W9XAN
Dec. 18	C	W9XAN		A	W6XK
Dec. 20	B	W9XAN	Jan. 22	BB	W9XAN
	A	W6XK	Jan. 24	BB	W6XK
Dec. 27	BB	W6XK		A	W9XAN
	A	W9XAN	Jan. 25	BX	W6XK
Dec. 28	BX	W6XK	Jan. 26	C	W6XK
Dec. 29	C	W6XK	Jan. 31	A	W6XK
Jan. 3	A	W6XK			

STANDARD FREQUENCY SCHEDULES

Time (p.m.)	Sched. and Freq. (kc.)		Time (p.m.)	Sched. and Freq. (kc.)	
	A	B		BB	C
8:00	3500	7000	4:00	7000	14,000
8:08	3600	7100	4:08	7100	14,100
8:16	3700	7200	4:16	7200	14,200
8:24	3800	7300	4:24	7300	14,300
8:32	3900		4:32		14,400
8:40	4000				

Time (a.m.)	Sched. & Freq. (kc.)	
	BX	
6:00	7000	
6:08	7100	
6:16	7200	
6:24	7300	

The time specified in the schedules is local standard time at the transmitting station. W9XAN uses Central Standard Time, and W6XK, Pacific Standard Time.

TRANSMITTING PROCEDURE

The time allotted to each transmission is 8 minutes divided as follows:

2 minutes—QST QST QST de (station call letters).

3 minutes—Characteristic letter of station followed by call letters and statement of frequency. The characteristic letter of W9XAN is "O"; and that of W6XK is "M."

1 minute—Statement of frequency in kilocycles and announcement of next frequency.

2 minutes—Time allowed to change to next frequency.

W9XAN: Elgin Observatory, Elgin National Watch Company, Elgin, Ill., Frank D. Urie in charge.

W6XK: Don Lee Broadcasting System, Los Angeles, Calif., Harold Perry in charge.

Schedules for WWV

EACH Tuesday, Wednesday and Friday (except legal holidays), the National Bureau of Standards station WWV will transmit on three frequencies as follows: noon to 1:00 p.m. E.S.T., 15,000 kc.; 1:15 to 2:15 p.m., 10,000 kc.; 2:30 to 3:30 p.m., 5000 kc. On each Tuesday and Friday the emissions are continuous unmodulated waves (c.w.); and on each Wednesday they are modulated by an audio frequency. The audio frequency is in general 1000 cycles per second.

Missouri State Convention

AFTER months of preparation, the first day of the Fifth Annual Missouri State Convention, Saturday, September 7th, dawned brightly and noisily in Joplin, Mo. About 11:30 order was established, and a welcome address to the group was delivered by Earl Brown, secretary of the Joplin C. of C., with a response by W9CJR, Dewey Mills of Mt. Vernon.

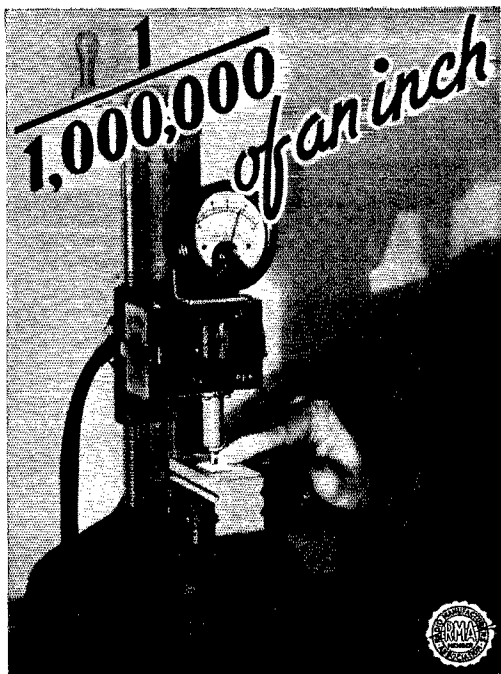

-that's BLILEY PRECISION!

To most people, one millionth of an inch is beyond comprehension . . . yet every Bliley LD-2 Crystal is checked in terms of these units for thickness and surface deviation on the precision electrical micrometer gauge shown at the left.

The thoroughness of the mechanical operations in manufacturing Bliley LD-2 Crystals is reflected in their greater activity, increased power output and freedom from spurious frequencies.

Remember, Bliley LD-2 Crystal units within 0.1% of your desired frequency or choice from stock, cost only \$4.80 at the nearest Bliley dealer.

The new Bliley fall catalog describes the complete line of Bliley Crystals, Holders and Ovens for amateur and general communication frequencies.

BLILEY ELECTRIC CO., ERIE, PA.

BLILEY LD-2 CRYSTAL UNIT

RAYTHEON AMATEUR TUBES

Type	Net Price	Max. Dimen.	Fila.	Pl. Volts—Output	DESCRIPTION TRIODES
RK-10	\$ 3.50	2 $\frac{1}{16}$ "x5 $\frac{3}{8}$ "	7.5v 1.25a	450v 10w	Modulator, R. F. Oscillator, Amplifier Thoriated Fil. Isolantite Base
RK-18	10.00	2 $\frac{1}{16}$ "x8 $\frac{1}{2}$ "	7.5v 3.0a	1000v 40w	Cl. B Mod, R. F. Osc., Amplifier Thor. Fil., Iso. Base, Plate Top Conn.
RK-24	2.25	1 $\frac{9}{16}$ "x4 $\frac{3}{4}$ "	2.0v 0.12a	180v 1.5w	Modulator, R.F. Oscillator, Amplifier Especially adapted for 56 MC Transceivers Oxide Fil., Isolantite Base
RK-30	10.00	2 $\frac{11}{16}$ "x6 $\frac{3}{8}$ "	7.5v 3.25a	1250v 65w	High Freq. R.F. Osc., Amplifier Plate and Grid Conn. Top of Bulb
RK-31	10.00	2 $\frac{1}{16}$ "x8 $\frac{1}{2}$ "	7.5v 3.0a	1250v 140 (2)	Zero Bias Class B Modulator, Isol. Base
RK-32	12.00	2 $\frac{11}{16}$ "x6 $\frac{3}{8}$ "	7.5v 3.25a	1250v 65w	Ultra High Frequency Triode P & G Supp. From Top of Hard Glass Bulb
RK-34	3.50	1 $\frac{9}{16}$ "x4 $\frac{11}{16}$ "	6.3v 0.8a	300v 14w	High Freq. R.F. Osc., Amplifier. Isol. Base Twin Triodes. Plate Conn's Top of Bulb
RK-100	7.00	2 $\frac{1}{16}$ "x5 $\frac{3}{8}$ "	6.3v 0.9a	110v 12w	Gaseous Discharge Amplifier Oscillator Extremely High Mutual Conductance
R-841	3.25	2 $\frac{1}{16}$ "x5 $\frac{3}{8}$ "	7.5v 1.25a	450v 13w	High Amplification Factor Audio Amp., R.F. Osc., Amp., Doubler
SHIELDED PENTODES—R. F. Oscillator, Amplifier, Doubler, No Neutralization Suppressor Mod. Carrier $\frac{1}{4}$ Power Shown					
RK-20	15.00	2 $\frac{1}{16}$ "x8 $\frac{3}{4}$ "	7.5v 3.0a	1250v 80w	Thor. Fila., Isolantite Base, Plate Top Conn.
RK-23	4.50	2 $\frac{1}{16}$ "x6"	2.5v 2.0a	500v 24w	Heater Type, Isolantite Base, Plate Top Conn.
RK-25	4.50	2 $\frac{1}{16}$ "x6"	6.3v 0.8a	500v 24w	Heater Type, Isolantite Base, Plate Top Conn.
RK-28	38.50	2 $\frac{5}{16}$ "x9 $\frac{1}{2}$ "	10v 5.0a	2000v 200w	Osc., R.F. Power Ampl. Cl. B & C. Thoriated Filament, Jumbo Isolantite Base
RECTIFIERS—MAX. PL. V. & NOM. PEAK CUR.					
RK-19	7.50	2 $\frac{1}{2}$ "x6 $\frac{3}{8}$ "	7.5v 2.5a	1250v 0.6a	Full Wave, High Vacuum, Low Voltage Drop, Heater Type, Top Conn. Anodes
RK-21	5.00	2 $\frac{1}{2}$ "x6 $\frac{3}{8}$ "	2.5v 4.0a	1250v 0.6a	Half Wave, High Vacuum, Low Voltage Drop, Heater Type, Plate Top Conn.
RK-22	7.50	2 $\frac{1}{2}$ "x6 $\frac{3}{8}$ "	2.5v 8.0a	1250v 0.6a	Full Wave, High Vacuum, Low Voltage Drop, Heater Type, Top Conn. Anodes
R-866A	5.00	2 $\frac{1}{16}$ "x6 $\frac{1}{2}$ "	2.5v 5.0a	3500v 0.6a	Half Wave, Mercury Vapor Shielded Filament, Plate Top Conn.
R-872A	16.50	2 $\frac{5}{16}$ "x8 $\frac{1}{2}$ "	5.0v 10.0a	3500v 2.5a	Half Wave, Mercury Vapor Shielded Filament, Plate Top Conn.

RAYTHEON PRODUCTION CORPORATION, 30 East 42nd St., New York, N. Y.

Let's Get Together

Your inquiry about any apparatus will prove to you that it is to your advantage to buy from me.

I give you specialized personal service of genuine value that is not available from other jobbers.

I take in trade apparatus you do not need on apparatus you do need. So I have used apparatus at big savings too.

I stock at lowest prices all amateur apparatus.

GOOD NEWS: All PR-16 models in stock for prompt delivery shipped prepaid. All receivers shipped on ten day trial. You need send only \$5.00 with order.

IN STOCK — IMMEDIATE DELIVERY

The new RME-69s	\$118.80
PR-16s (at last) prepaid	95.70
National HROs	167.70
Bretting 12s complete prepaid	93.00
Silver 5Ds complete prepaid	109.80
Super-Sevens complete prepaid	49.50
The new Super Skyriders complete prepaid	79.50
RCA ACR-136s complete	69.50
Super Pros complete	194.04
Collins and RCA transmitters	

TRADE IN YOUR RECEIVER OR TRANSMITTER

Every inquiry and order is personally attended to by Robert Henry, W9ARA; an active amateur for eleven years; graduate E.E. from M. I. T.; and owner of Henry Radio Shop selling amateur apparatus for seven years. Write for any information.

HENRY RADIO SHOP

211-215 North Main St. Butler, Missouri

"The Crystal Specialists Since 1925"

PIEZO-ELECTRIC CRYSTALS

Guaranteed Accurate to BETTER than .01%

SCIENTIFIC RADIO SERVICE

UNIVERSITY PARK, HYATTSVILLE, MD.

YOU'VE GOT TO BE GOOD!

Just being able to pass license requirements on code speed isn't enough, in this day of competition and ultra-fast operators. You've got to be

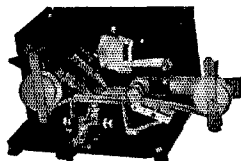

MASTER TELEPLEX
"The Choice of Those Who Know"

FAST and ACCURATE

— both on the giving and the taking! TELEPLEX will boost your copying speed tremendously and in a comparatively short time. Still more important to your reputation among other ops — TELEPLEX will help you to *catch those bad habits* in your key technique! — Habits you can't even detect yourself, unless you can stop your fist and *listen to your own sigs* coming back to you! That's what TELEPLEX does — fires your own identical signals right back, imperfections and all! Maybe you didn't realize your "the" sounds like a "G-E" or your "and" like "A-D." TELEPLEX will tell you! Your sending is recorded on copper tape which in turn operates a key which sends to you. Or you may use tape recorded by the world's best operators. TELEPLEX is the best, most widely used code teacher. We furnish a complete course, lend you the improved MASTER TELEPLEX and give you personal instruction with a MONEY BACK GUARANTEE. Send for our new TELEPLEX FOLDER Q36 today. IT'S FREE.

TELEPLEX COMPANY

76 CORTLANDT STREET

NEW YORK

Time out for lunch was called, and at one o'clock the phone and c.w. round tables were scheduled under the leadership of Rev. Fox, W9ESL, and Bert Robbins, W9ENF, respectively. It was finally decided to combine the two meetings, and they ended in the usual vigorous but friendly arguments.

The prefix contest, conducted by J. C. Murphy, W9GLY, the capable treasurer of the Ozark Amateur Radio Association, to whom the financial success of the Convention is due was won by W9OLC, William Hanks of Fulton, Missouri, and the cracker-eating contest Sunday morning was won by Lee Culbertson of Joplin, a ham-to-be.

On the afternoon program was Clinton B. De Soto from headquarters, who spoke on "The Mechanics of Modulation." This was Saturday's most important contribution to the educational feature of the convention. The always-welcome Midwest Division Director, "Grandpa" Kerr, W9GP, entertained the group for the next hour, followed by the Raytheon representative, Mr. Argento.

Another interim for supper, and then the entertainment feature. Here, through an oversight on the part of the manager, the error in the program announcing a YL and OW Party in place of the dance planned was not corrected, so that this part of the program was slighted by most of the gang. However, those in the "know" reported a very pleasant evening, with Dick Davis' orchestra and Miss Egleston's little dancing pupils doing a lot to help things along. The "stag" held in the Silver Dollar night club across the street from the hotel turned out to be "just another stag," with more headaches than thrills, from all reports next day.

Sunday's technical talk was on new tubes and circuits by Guy Wilson, W9EL, from Radio Laboratories in Kansas City. The Army and Navy discussions were led by W9EFC, F. E. Norwine, Jr., of University City, Mo., State Net Control for the A.A.R.S., and by W9CFL, Lieutenant A. W. Hodge, of Kansas City, U.S.N.R.

Immediately after the group picture was snapped at one o'clock, Mr. De Soto again took the floor, speaking this time on "International Amateur Radio Affairs," with special reference to the expansion of the amateur bands to be discussed at the Cairo Convention and urging wholehearted participation in the Cairo surveys.

At 2:30 the banquet, an excellent example of the Connor chef's ability, was served by black-faced, white-coated waiters in the Empire Ballroom of the Hotel Grace was said by Rev. Fox. Leo Knaust, W9TGN, president of the O.A.R.A., was toastmaster, and introduced the "notables of Hamdom" and three of the YL's present, Misses Ida Allendorf, W9SRH, and Letha Allendorf, W9OUD, of Joplin, and Miss Opal Sisk, W9CMV, of Pittsburg, Kansas. The prize drawing was efficiently conducted under the management of W9PRO, Jack Williams, and an informal trading bee and auction was held in the rear of the dining hall immediately afterwards.

The Fifth Annual Missouri State Convention of Radio Amateurs is History!

—W9OUD

1935

Troubles

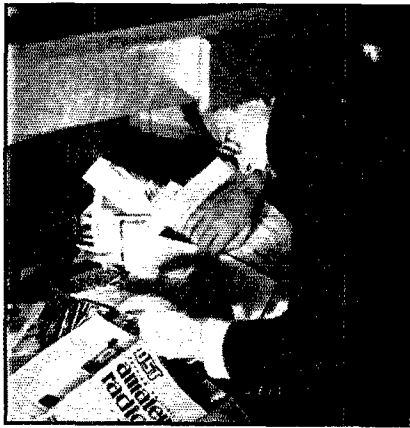

CAN BE
OVERCOME

IN

1936

With

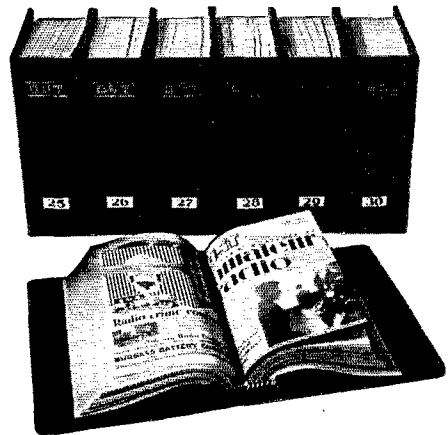

QST
BINDERS

priced at
\$1.50
postpaid

(Not available outside of the United States and Possessions, and Canada)

(One set of yearly labels (1919-1938) now provided with each binder)

American Radio Relay League
West Hartford, Connecticut

PERFECT CONTROL

for
Maximum
Tube Life
and
Best
Performance

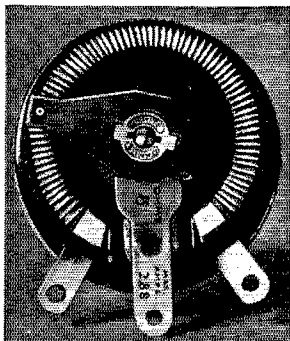

For perfect control in your tube filament circuits, accepted practice specifies a rheostat in the transformer primary circuit. This hook-up, which prevents unbalancing the secondary, calls for a heavy-duty OHMITE Rheostat. There are no organic materials to smoke or char in these all-porcelain units. They give smooth gradual control! Stocked in a wide variety of sizes and values. Ask your Jobber or write for Catalog 14.

OHMITE MFG. CO.

New Enlarged Quarters at

4831 FLOURNOY STREET

CHICAGO, ILLINOIS

RADIO ENGINEERING

RCA Institutes offers an intensive course of high standard embracing all phases of Radio, Practical training with modern equipment at New York and Chicago schools. Also specialized courses and Home Study Courses under "No obligation" plan.

Illustrated Catalog on request.

RCA INSTITUTES, INC. Dept. ST-35

75 Varick St., New York 1154 Merchandise Mart, Chicago
Recognized Standard in Radio Instruction Since 1909

PRECISION CRYSTALS

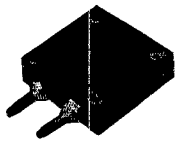

Crystal Holder—\$1.00

1750 and 3500 kc. bands — \$3.00 each, 7000 kc. band — \$3.50. Add \$1.00 to above prices if plugin, dustproof holder is desired. Jacks to plug holder into — \$1.15 pair.

The 'AT' cut crystal recently developed has a temperature coefficient of practically zero and will handle more power than ordinary crystals. 'AT' cut crystals ground to your specified frequency accurate to 0.1% and calibrated to within 0.03% are priced as follows: 1750 and 3500 kc. bands — \$6.00 each. Crystal holder — \$1.00. Jacks for holder \$1.15 pair.

Crystals and ovens for commercial use quoted on at your request. When ordering our product you are assured of the finest obtainable. Now in our sixth year of business.

PRECISION PIEZO SERVICE

427 Asia Street

Baton Rouge, La.

Circulation Statement

PUBLISHER'S STATEMENT OF CIRCULATION AS GIVEN TO STANDARD RATE AND DATA SERVICE

This is to certify that the average circulation per issue of QST for the six months' period January 1st to and including June 30, 1935, was as follows:

Copies sold.....	42,155
Copies distributed free.....	371
Total.....	42,526

K. B. Warner, Business Manager

D. H. Houghton, Circulation Manager

Subscribed to and sworn before me on this 6th day of September, 1935.

Alice V. Scanlan, Notary Public



Power Transformer Design Circular

INFORMATION for the Amateur Designer of Transformers for 25- to 60-Cycle Circuits," by Herbert L. Brooks, is a circular recently made available by the National Bureau of Standards. Design information on transformers ranging from 1 volt-ampere to 10 kilovolt-amperes (1 watt to 10 kilowatts at unity power factor) is given by graphs which eliminate laborious computations. Essential wire data are included, and methods of constructing the coils and assembling the core are explained. Although the method is intended primarily for 60-cycle design, instructions are also given for adapting the procedure to 50- and 25-cycle transformers. The information is directly applicable to step-down filament transformers and medium-voltage plate-supply transformers. The insulation problems involved in higher-voltage step-up transformers are less adequately covered. A helpful feature is a listing of firms from which silicon-steel core sheets and magnet wire can be obtained in small quantities. Copies of this publication (Circular No. C408) can be obtained from the U. S. Government Printing Office, Washington, D. C., at 5 cents each (cash or money order—no stamps accepted).

A New Receiving System

(Continued from page 37)

stable signals, substantially inaudible on the straight superregenerator were very strong and healthy with the new sets.

HISS NOT TO BE TOLERATED

It should be remembered that this type of superregenerative detector, with the input heavily loaded, may be operated in an extremely sensitive condition with the characteristic hiss or "rush" just above audibility. Indeed, the tube may be superregenerating with no audible hiss whatever. Ordinarily, we operate the receiver in this fashion—cranking the audio gain control over toward maximum. When the going gets very tough because of ignition QRM or very weak signals, we give the superregen. detector more "gas" and back off on the audio control. The

(Continued on page 110)

Build This *NEW* 18-Watt THORDARSON SPEECH AMPLIFIER

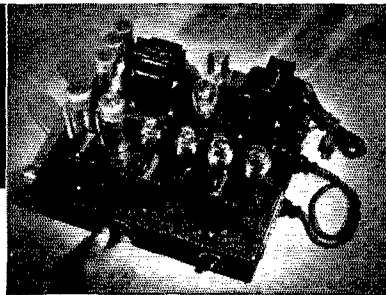

with Special Foundation Unit and Standard THORDARSON Transformers

● Here is a speech amplifier specially designed for amateurs, developed in the THORDARSON laboratories by W9SGA and W9UVP, and incorporating the very latest developments. While its cost is low, this amplifier gives the finest professional performance. It provides high fidelity amplification, has exceptionally high gain, a low hum level, and realizes its full-rated power output without distortion.

Write for details on
6-Watt &
30-Watt
Models

All parts, including the Foundation Unit drilled and ready for assembly, can be obtained from your distributor. Complete assembly instructions furnished free. By building this amplifier you can save from \$20.00 to \$40.00 over ready-made jobs, yet have a decidedly superior unit.



Ask Your THORDARSON Distributor for Descriptive Catalogs, or Write

THORDARSON ELECTRIC MFG. CO.

500 W. Huron St., Dept. B, Chicago, Ill.

OUTSTANDING FEATURES

- High fidelity reproduction.
- Full output without distortion.
- 114.9 D. B. gain with crystal mike.
- Integral pre-amplifier.
- Hum is negligible.
- Input for all types of microphones.
- Over-all gain compensated for any type input circuit.
- Designed for rack or table mounting.

YOU CAN DEPEND ON G-E PYRANOL CAPACITORS

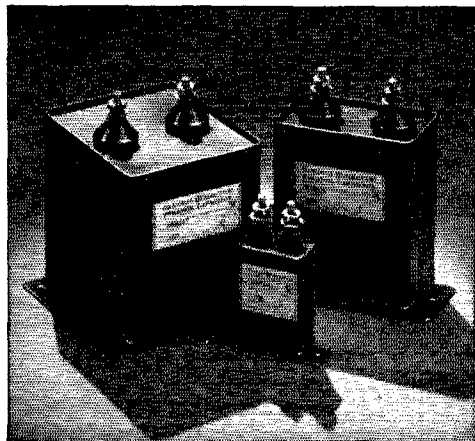

THEY'RE inexpensive, too, and scientifically designed. Years of experience in manufacturing capacitors for leading broadcast and short-wave communication stations and the government are built into them. Big, cumbersome capacitors need no longer use valuable space in your transmitter. Nor do you have to worry about fire — Pyranol won't burn. You can use more voltage — G-E Pyranol capacitors will stand continuous operation up to 10 percent above rated d-c. voltage. They make possible better signals and have longer life. Get them from your dealer. Radio Department, General Electric, Schenectady, N. Y.

360-101

GENERAL ELECTRIC

Say You Saw It in *QST* — It Identifies You and Helps *QST*

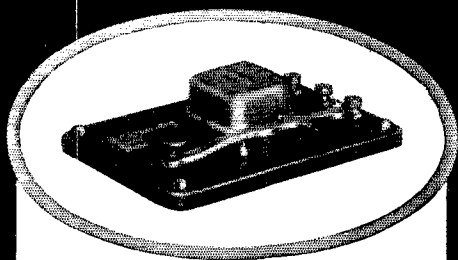

WIRELESS PRACTICE SET

This Wireless Practice Set was designed for those who want an inexpensive instrument to learn the code. Operates from standard dry cell batteries. Two sets connected will operate up to a distance of 1000 feet. List price, \$1.75.

SIGNAL's line of Wireless Keys, Telegraph Instruments and Wireless Practice Sets is complete. Send for our bulletin.

SIGNAL ELECTRIC MFG. CO.
Menominee, Michigan, U. S. A.

SIGNAL
MANUFACTURERS OF ELECTRICAL PRODUCTS

T. R. McELROY

World's Champion Radio Telegrapher

23 BAYSIDE STREET, BOSTON, MASS.

Actually stocked by nearly all "ham" jobbers

MAC KEY @ \$7.95

I believe it to be the finest semi-automatic ("bug" type) key built.

JUNIOR MODEL @ \$4.95

At last! A low priced semi-auto that really works! Guaranteed!

MAC-AUTO less than \$100.00

Completely automatic, all electric, 5 wpm to 200 wpm. Wonderful for schools, clubs, etc.

See my full page in new A.R.R.L. Handbook.

73, Mac.

VALPEY FREQUENCY CONTROL UNITS FOR THE AMATEUR BANDS

Low frequency drift
High power output
Tube socket mounting
Frequency calibration .03%
May be used with high power oscillator tubes
Fully guaranteed.

Valpey crystals may be obtained from your dealer or by ordering direct.

160, 80 and 40 meter bands **\$3.00**

The Valpey Crystals

377 Summer St., Medway, Mass.

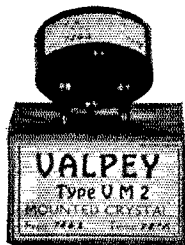

\$3.00

I.A.R.U. News

(Continued from page 60)

12 Kroner Speaking of Andorra, as we were earlier, PX1A in that country is the highest station in all Europe—10,000 feet above sea level The tiny little Republic of Andorra has an area of 175 square miles, a population of 5000 PX1A, who operates under cover, speaks fluently English, French and Spanish, writes PY1AW The C.A.V. joined with the members of Masaryk's Flying League and of Czechoslovak Motorists last summer in "pursuing" and capturing a stolen motor by means of airplane and radio The car ran in a radius of 30 miles; it was "captured" in 90 minutes Operated by OK1SBX, OK1KX, OK1FF and OK1PP, a 15-watt portable transmitter was used in the plane on 3.5 mc. A large amount of public acclaim followed the exhibition

Special:

Comes now "CQ-PK," official organ of the N.I.V.I.R.A. in Netherlands Indies, a multi-graphed sheet running to about 15 pages. Reproduced in surprisingly legible manner are circuit diagrams and technical matters which would do credit to a much more pretentious sheet. A baker's dozen of articles appear in the latest issue to hand, that of August, 1935. All credit to the enterprising leaders of N.I.A.V.I.R.A., a struggling society, lacking in numbers but not in enthusiasm, for this production. Interested amateurs, capable of reading the Dutch language, should communicate with the editor, PK1CF, Th. A. F. Leyzers vis, V. Heutzboulevard 2, Batavia-Centrum, D.E.I.

Experimenters' Section

(Continued from page 45)

"The oscillator here is keyed and perfect break-in can be used by holding the signal from the transmitter down to a level comparable to the received signal. This system was sought after primarily for listening to my sending while using a bug, but its other advantages are also important."

(Continued on page 108)

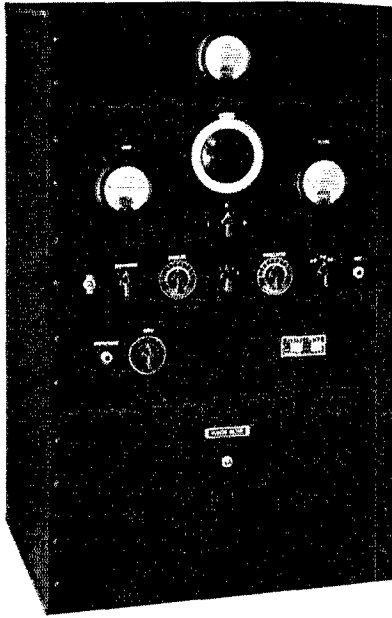

THE NEW 200-R TRANSMITTER OFFERS THREE SUPERIOR OPERATING ADVANTAGES



and a host of other constructional features not to be found in standard transmitters at much higher prices. The final stage employs an RK-28 delivering a carrier output of 200 watts on CW and 60 watts on PHONE.

The 60-T Transmitter with band and crystal selection is making a niche for itself in the medium power class.

Write for details and prices on these two outstanding transmitters

Harvey Radio Laboratories, 12 Boylston St., Brookline, Mass.

BIGGER and BETTER VALUES from the RADIO SHACK

PYRANOL

2MFD-2000 VOLT

(Operating)
FILTER CONDENSERS

Impregnated and filled with Pyranol. We rate these at 2000 volts working and we know of cases where they are in use at a 50-75% overload. Made by one of the world's largest manufacturers of electrical apparatus.

... UNSOLICITED — READ IT.

... "The Pyranols we bought from you 8 months ago going strong at 200% overload ... Please send us 1 more."

Guaranteed Unconditionally for 2 Years. No Restrictions as to use!



\$2.90

866's Heavy Duty
\$1.00
Each

**INTERNATIONAL
PLATE
TRANSFORMERS**

Outstanding for Value. 750 and 1000 volts each side of c.t. at 300 mills. Cased completely in steel, crackle finish. Model 2000 ... **\$5.95**
Model 3000 — Same in appearance, 750-1000-1500 each side of c.t. 300 mills. ... **\$8.95**
We know of nothing that equals the value received in these two items.

Baldwin Type "C" Phones
\$2.50

210 R.C.A. **\$1.20**

250 R.C.A. **\$1.50**

CARDWELL CONDENSERS in stock 40% discount. Catalogue sent on request.

Used F.B. 7A. 4 sets coils. ... **\$35.00**

Mail Orders Filled — Send Check or Money Order

THE RADIO SHACK

46 BRATTLE STREET • BOSTON

5imac 50T.....	\$13.50
5imac 150T.....	24.50
H.K. Gammatron....	24.50
R.K. 20.....	15.00
R.K. 25.....	4.50
RS. 800.....	5.95
RS. 801.....	2.95
VT. 203A Graphite..	9.00
Unico Keying Relay	2.00
Signal Straight Key..	.90
Astatic Crystal Mike	13.50
Amperite Velocity Mike.....	18.00
Peak Pre-Selector....	19.80
Johnson 5M Ant....	3.90
Birnback 5M Ant....	1.50
Pioneer Gen-E-Motor.....	10.80
100 Mill — 30H.....	.90
Choke.....	.60
65 Watt Iron.....	.60

Thordarson Trans. 600-0-600V-200 Mills. 2.5v-12A — 5v-3A — 7 1/2v-3A **\$2.75**

Triplet 3" Bakelite Cased Meters
0-5 to 500 Mill DC.....**\$3.75**
0-150 AC Volts..... **3.75**
0-1 Mill DC..... **4.55**
0-15 Volts AC..... **4.55**

Ohmite Band Switches **\$1.80**
Billey LD Crystals. **\$.480**

STANDARD RELAY RACKS

Beyond Comparison

Not just another rack of odd design but the lowest priced Rack ever offered that included all the standard features that made the rack you wanted so high priced.

- Sturdy 3" steel channel frame.
 - All joints welded
 - Drilled and tapped for 10/32 screws.
 - Holes spaced at 1 1/4" and 1/2".
- (This is the only standard for 19" panel)

\$13.50

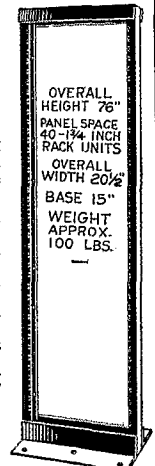

OVERALL HEIGHT 76" PANEL SPACE 40-1 3/4 INCH RACK UNITS

OVERALL WIDTH 20 1/2" BASE 15" WEIGHT APPROX. 100 LBS.

INTERNATIONAL Smoothing Mills	CASED CHOKES Swinging Chokes
12H. 200.....	\$2.50
12H. 300.....	3.75
12H. 500.....	6.50
5/25H. 200...	\$2.50
5/25H. 300...	3.75
5/25H. 500...	6.50

International 10V-6.5A Trans. (cased). **\$2.50**

Precision Built — Laboratory Tested
New Super Sky Rider
Model SX-9.....**\$79.50**
With Xtal **\$10.00** extra

Delivery the day you place your order

USED TUBES

All Guaranteed

RCA 204A.....	\$30.00
RCA 849.....	40.00
RCA 852.....	12.00
RCA 860.....	12.00
RCA 865.....	5.00
WE 267A.....	9.00
WE 212D.....	15.00
WE 276A.....	9.00
WE 242A.....	9.00
WE 261.....	9.00

RAYTHEON VOLTAGE REGULATOR

Stabilizes AC Voltages to $\pm 1\%$

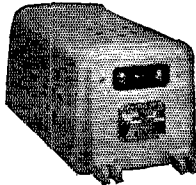

Type VR-2

60 WATTS

\$27.00

Input may fluctuate from 95-130 volts AC. Load may fluctuate from 0 to full load. Output will remain 115 volts $\pm 1\%$. Time constant is negligible. Automatic — no moving parts or adjustments. Sizes up to 2000 watts.

Write for Bulletin DL-48-711Q

RAYTHEON MANUFACTURING CO.

Electrical Equipment Division

190 Willow Street ■ Waltham, Mass.

ACME-DELTA, RAYTHEON, AND DELTA
PRODUCTS

A NEW BOOK • Second Edition of FUNDAMENTALS OF RADIO

(426 pages 6" x 9", 430 figures)

By Professor R. R. RAMSEY, Ind. Univ.
Revised, enlarged, repaged, reprinted, New cover



New subjects: Multi-electrode Tubes; A, B and C amplifiers; and Cathode Ray Television. Radio theory and practice brought up to May, 1935. Problems and questions on each chapter. "The presentation is clear and logical. — More general principles are first passed in review, and a return is made later to consider them in detail and to point out their applications in practice." *Proc. I. R. E.*

EXPERIMENTAL RADIO You have heard of the original radio manual of experiments. Get it. Prices: Fundamentals \$3.50; Experimental \$2.75 postpaid. Your check, postal order or C.O.D. brings 'em.

RAMSEY PUBLISHING CO.

Bloomington, Indiana

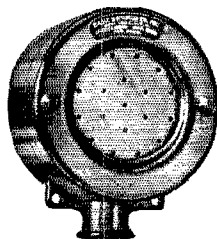

The Superiority of Our
**DYNAMIC
MICROPHONE**

Over Other Types Is
Mainly in Its Sensitivity

No high gain preamplification required. No background noise. No Power Supply. **AND THE PRICE \$30**

U. S. PATENTS PENDING

Send for Bulletin 3011

RADIO RECEPTOR CO., INC.

110 Seventh Ave., New York City

Notes on Regenerative S.S. Receiver

A great many constructors have written to me regarding construction of the S.S. receiver described in May 1934 *QST*, and in recent editing of the A.R.R.L. *Radio Amateur's Handbook*. While the *Handbook* specifications are correct, a typographical error in the article gave an improper value for R_{16} , which should be 25,000 ohms, 5-watt, instead of 2,500 ohms. With the lower value too high screen voltage on the second detector and plate voltage on the beat oscillator were applied, making the signals seem very weak. With correct value of all resistors the following voltages measured with a 200-ohms-per-volt voltmeter against ground (chassis) were obtained. The range of values is for the two extreme positions of the volume control R_3 .

Tube	Plate	Screen Grid	Cathode
R.F.	170-180	60-85	0-30
1 Det.	170-180	10	0-25
H.F. Osc.	170-180	75-85	0
I.F.	165-175	67-70	3
C.W. Osc.	75-85	7-10	0
2 Det.	150-170	75-85	0

In the September, 1935, issue of *QST*, W9NQV describes an effective means of adding a stage of audio amplification to the receiver, although this should not be necessary unless loud speaker reception of weak signals is desired on 20 and 10 meters where the gain is not as great as on the lower-frequency bands. A simple expedient which will increase the gain considerably on these bands is to use a 57 first detector in place of the 58, and to use the 40-meter coil on 20 meters and the 20-meter coil on 10 meters in the separately tuned r.f. stage.

Satisfactory coils for 10-meter reception can be wound on the small-sized National isolantite forms. L_4 and L_5 are each 3 turns spaced to one inch length of winding and L_6 is tapped one turn from the ground end, both coils of No. 18 enameled wire. L_3 is composed of 3 turns of No. 36 d.s.c. wire close-wound $\frac{1}{6}$ inch from bottom of L_4 . The holes in these forms make all these spacings readily attained.

—R. W. Woodward, W1EAO

The Young Squirt's Epistle

(Continued from page 40)

over the transom and putting both feet through a couple of meters.

Your ilk, he said, getting up, are just the sort that gum up the air, and if you are hankering after trouble, just go on the air again without a filter, son. With that he moves toward the door. And another thing, he adds, don't say anything against the Old Man.

I snatched up a book, which was the nearest thing in reach, and threw it at him so hard I slid under the bed and got all tangled up in some wire. He ducked and I heard him grunt as he

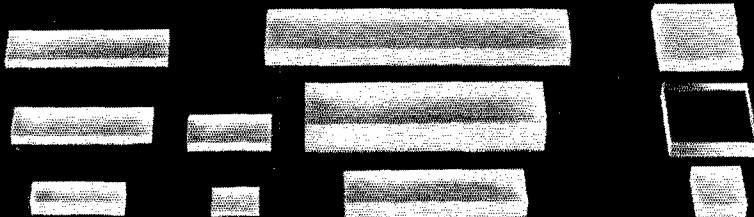
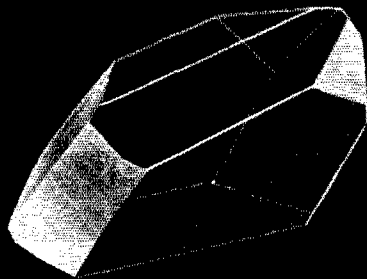

Write for Bulletin 103 describing ISOLANTITE Holders, "AT" Cut Crystals, etc.



PREMIER CRYSTAL LABORATORIES, Inc.

53 PARK ROW, NEW YORK CITY, U. S. A.

INCREASE YOUR POWER!

with
the
GENUINE

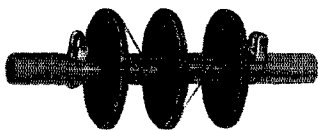

NAVY
TYPE
CHOKE

AVAILABLE ON ISOLANTITE OR BAKELITE
200 ma. \$1.25 . . . 500 ma. \$1.35 . . . 1000 ma. \$1.50.
On Isolantite 15c extra. Usual Discount at your jobber.

Genuine Navy Type Chokes

Are used and endorsed by hundreds of Broadcast Stations and thousands of amateurs.

AMATEUR SERVICE SALES, 1240 Fullerton Ave., Chicago

Write for literature

INSTRUCTOGRAPH

**THE PRACTICAL
CODE TEACHER**



To learn the code or increase speed, you want to study the most practical way. With the Instructograph, you can study more easily than at a school or by listening to Short Wave. You can practice when you like and where you like — regardless of schedules or interference.

With each Instructograph, sold or rented, comes Book of Instructions written by an expert operator. This book explains each step, just as an instructor would do, and shows you how to study to best advantage.

The Instructograph is a sturdy, well-made machine, good for years of use. But if you want it to prepare you for a code test or to increase your speed to a desired rate, it may be that a month's use will answer your purpose; the Instructograph, Tapes and Book of Instructions may be rented on very attractive terms. Write today for free descriptive folder and price list.

INSTRUCTOGRAPH COMPANY—Dept. Q12

912 Lakeside Place

Chicago, Illinois

Representatives for Canada

RADIO COLLEGE OF CANADA, LTD., 863 BAY ST., TORONTO

Help

**For the
AMATEUR**

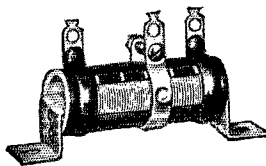

USE Electrad "Variohm" Dividers and get exactly the right plate, screen and suppressor voltages for those new pentodes. Five sizes from 25 to 200 watts to suit all power packs. 85c to \$3.75 each list.

Write Dept. Q-12 for Complete 1936 Catalog of Resistors for All Purposes



EBY

Specializes in Quality

**Binding Posts
Tip Jacks Male Plugs
Female Plugs
Low-Loss Sockets
A-C Switches
Tap Switches
Terminal Strips
Short Wave Switches
Moulded Sockets
Electric Eyes**

Write for Latest Bulletin

HUGH H. EBY Inc.
2066 Hunting Park Ave.
PHILADELPHIA, PENNA.

GULF RADIO SCHOOL

Radiotelegraphy Radiotelephony
Radio Servicing

SECOND PORT 1007 Carondelet Street
U. S. A. NEW ORLEANS, LA.

DESK TYPE MICROPHONE STAND



Modernistic design
beautifully finished
in black crackle
COST TO RADIO AMATEUR
\$1.20

CAN BE BOUGHT FROM YOUR
RADIO JOBBER

A BUD Catalog showing complete line of
Microphone Stands and other Short Wave Parts
will be sent to any Radio Amateur upon receipt
of a three cent postage stamp.

BUD RADIO INC.

1937 E. 55th Street

Cleveland, Ohio

picked it up: "Wireless Course in Twenty Lessons," he grated. You ain't changed none. And then he was gone before I could get untangled and give him the piece of my mind that I had been holding in reserve. But here's the point: That old fossil could have passed for you, he was so dad-ratted onery. If he had taken off that muffler I could have then noted whether he had yore foliage. What I want to know is, was it you? If it was, just remember that you will have to grow up some more before you can get the best of me in an argument, and this Sherlock Holmes stuff ain't going to get you nowhere. I can put it over you like a tent, just like I did this time.

Yours,

THE YOUNG SQUIRT

Utility Type Switchboard

(Continued from page 18)

The FBX, its pre-selector, and an SRR super-regen receiver are supported on shelves in the rear, their fronts being let through windows cut in the panel as shown. Incidentally, if you make up a panel and then decide later that you require a different layout, you can throw the original panel away and make up a new one without much trouble and at very slight expense. The chasses on which the various transmitter units are assembled are mounted on shelves in the rear of the board.

Be sure and provide plenty of jacks to which to connect the receiver outputs, matching transformer inputs and outputs, monitors, and loud speakers, so that the rig will be as flexible as possible.

Mounting the switchboard across the corner of a room as shown in Fig. 1 is desirable because it gives more room in the rear in which to work. Put in plenty of service outlets in the rear of the board so that the trouble-light and soldering iron may be moved about as required. Double outlets which can be mounted on the uprights with wood screws can be obtained for 15 cents and do very well.

One very helpful, if not desirable, feature which has become evident with this type of construction is that the board can become quite haywire in the rear when schemes are being tried out and still preserve a fairly respectable appearance from the front.

The All-Around Signal Squirter

(Continued from page 17)

proved here in action. On one occasion we were QSO "Three Mud Ducks" and had the old simple antenna in use for a check. Things not being what they might be, the inquiry came from W3MD as to whether we had the "Bull's Horns"

Announcing

RADIOLAB AIR DERBY

Fun? Oh Boy! PRIZES!

The Tops!

FIRST PRIZE

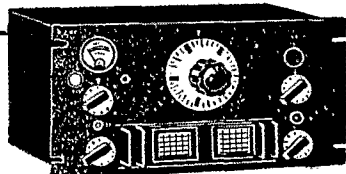

NATIONAL HRO

SECOND PRIZE
Radio Mfg. Engineer's
FAMOUS RECEIVER
RME-9DS

The Rules

- You buy nothing.
- Contest opens 12:00 noon, December 7. Closes 12:00 midnight, December 15.
- Contact and list as many stations as possible having the same number you have. You need not give names and addresses; calls only are desired.
- Mail your list with your call and number to Contest Editor, Radio Laboratories, 1515 Grand, Kansas City, Missouri.
- Entries must bear a December 16 postmark.
- First prize will be awarded the ham turning in the longest list of correct calls, second prize for the second longest list, etc. Each correct call counts one point.
- Judges decisions are final.
- Every recipient of the Radiolab Ham Bargain Bulletin may enter except employees of Radiolab and employees of co-sponsoring manufacturers.
- Winners will be announced in February QST.

14 Other Major Prizes

Here's the Dope!

● In an effort to express our appreciation of the patronage you have so generously given Radiolab and the manufacturers of our ham equipment, we are co-sponsoring this contest. And what a contest!

● Our Fall Ham Bargain Bulletin is being released simultaneously with appearance of this announcement. You must receive this bulletin to participate in the contest. If you have received our Ham Bargain Bulletins in the past, this Fall edition will reach you approximately December 1; if you have not received past issues, write us now so that your name will be registered and a bulletin sent in time for the contest. Every copy of the Ham Bargain Bulletin is numbered. Your number will be found on the address sticker to the right of your name. That is your number in the contest and there are other stations who have been assigned this same number. We have a record of every station's number here at Radiolab.

● The object of the contest is for you to locate and list as many stations as possible who have the same number as yours. We are sending a Bargain Bulletin to every amateur on our mailing list (about one-half the Hams in U.S.A.) and guarantee at least 100 stations have been assigned the same number you have. It's been a lot of work but now we are all ready for the fun.

● The contest is short and snappy and will test your operating skill and ingenuity. Anything goes as long as you abide by the simple rules. Here are a few suggestions: CQ for your number, thus CQ56. Organize a network for exchange of numbers. Keep a record of every number you find, even though it is not yours, and trade your list with other stations. Make your CQ's and contacts short and eliminate QRM. Above all else don't get discouraged — this is a tough contest and remember a score of 10 points may be a high one.

● We hope we have devised a contest here that will appeal to every ham and only regret that we ourselves are automatically eliminated from participating in the fun. Every one of you fellow amateurs who receives a Bargain Bulletin is registered and in the contest, no formal entry, no acknowledgment is required. Read the simple rules and get your rig ready for the big event.

Full list of Prizes—
Your Registration
Number is in the
Watch for it!

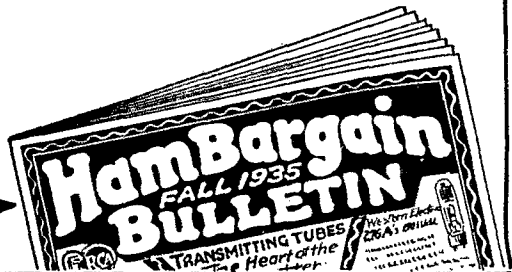

RADIO LABORATORIES
1515 GRAND AVE.
KANSAS CITY, MO.

The New 1936 Twice-as-Big Handbook

WILL MAKE THE IDEAL

XMAS PRESENT

Simply send in your order now with name and address of the person or persons to whom it is to be sent, giving the name of the donor. We'll do the rest—see to it that the new **HANDBOOK** reaches destination on or before December 25. A suitable gift card will be sent with each copy. Swell idea, huh?

\$1 POSTPAID IN U. S. A. AND POSSESSIONS

● Elsewhere, 15c Additional to Cover Postage
Buckram Bound, \$2.50

AMERICAN RADIO RELAY LEAGUE
West Hartford, Conn.

IMMEDIATE DELIVERY ON THE NEW
1936 RME-69 RECEIVER
DOWN PAYMENT—ONLY \$30.00

See Page 91 for Complete Details

DELAWARE RADIO SALES COMPANY
405 Delaware Ave., Wilmington, Del.
WILLARD S. WILSON—W3DQ

HIPOWER CRYSTALS

THE NEW and IMPROVED
Completely shielded I. F. Crystal
Unit. Designed especially for the S.S.
RECEIVER.

Incorporated in new receivers by leading set
manufacturers.

Supplied in 3 freq. 525 Kc. 500 Kc. and 465 Kc.
See it at your dealer's or write for descriptive
Literature.

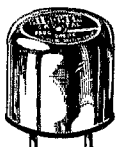

TYPE IFS.
Price \$5.45

LOW DRIFT TRANSMITTING CRYSTALS

Thick cut, low drift "AH" cut crystals are from 2 to 40 times
as stable as the X or Y cuts. Supplied within 10 Kc. of specified
frequency or choice of dealer's stock.

	1700-3500 Kc.	7000-7300 Kc.
"AH" 10	\$2.35	\$5.90
"AH" 5	3.90	5.90
"AH" 2	8.90	12.90

The number following "AH" is the drift in cycles per °C. per
1000 Kc.

ORDER FROM YOUR DEALER—or direct

Send for Descriptive Literature

HIPOWER CRYSTAL CO., 2035 W. Charleston St., Chicago, Ill.

headed in his direction. We had to answer that the Signal Squirter was not on the transmitter. A couple of minutes' delay and the Squirter was put in service—and the QSO was finished without further interference. Which, after all is said and done, is what we are looking for.

Was it worth the effort of three months of hard work and experimentation, failures and all sorts of other discouragements? (To say nothing of the sarcastic remarks from neighbors who don't have all the sympathy for amateur communication that they might—except when they want to talk to some of their friends or relatives.) The answer is YES; a thousand times, YES. If a tornado blows along tomorrow and takes the whole thing with it—well, we have the experience and it would take only a little time to get another up and in working order. We are sold on the system and the results are so far ahead of what we had hoped for that we are all set, at least until such time as some one of the brethren of our great fussing fraternity can tell us how we may add means for tilting the rotatable assembly to give control of the angle of vertical propagation. But then, if that were done, we would have to have a boy stand by and fan us while we pushed the buttons to tilt and rotate. For fear that the boy might not be handy some time when we wanted to go through the various contortions, and since we don't see how to do it anyway, let's just forget that part for the time being—and have a bit of fun on the air for a change.

28-Mc. WAC Accomplished

(Continued from page 11)

U. S. districts, using about 50 watts input to a push-pull final stage, fed from an 80-meter crystal oscillator and a series of doublers to ten. His antenna consists of two half-waves stacked vertically and fed in phase through a quarter-wave matching transformer and twisted pair transmission line. His seems to be an ideal part of the world for ten-meter work with Europe and America, particularly, since the north-south transmission path appears to be much more consistent than east-west. We hear him working Europeans when none can be heard or are very weak here.

The J's are quite consistent on the West Coast, but are heard very rarely in the East and Middle West, the only reported instances of reception in these districts being by W3FAR, W4AGP and W8CRA. There are lots of W1's, 2's, 3's, 4's, 5's, 8's, and 9's that need only Asia for that ten-meter WAC! The 6's and 7's, on the other hand, have found Europe and Africa the chief stumbling blocks.

As this is being written it appears that the peak of this DX period has passed, but it may be only a temporary lull. That, in fact, is one of the things that makes "ten" so fascinating to some hams and gives the opposite type a pain—you never know what's going to happen, or when. Luckily there are enough of the inquiring type to

Meet the Family—

of Johnson Transmitting Tube Sockets, every one worthy of the name it bears.

● You'll find in them, firm contacts of phosphor bronze, smooth acting, never failing; bases of fine, smoothly glazed low absorption porcelain; heavy metal shells to provide adequate support to valuable tubes.

Of course, you already know the parents, No. 211 "50 watt," and No. 210 "Navy, or UX, base," and their first cousins 211FB and 210FB for vertical panel mounting. Precocious youngsters are the No. 216 Giant 5 Prong socket for the RK28 and RCA803, and the twins, the 215 Socket Set for "250 watt" tubes, featured by the Safety Cup plate terminal.

Prices are really low — for example, the No. 211 "50 watt" size has lately been reduced to \$1.75 list; the No. 216 is \$2.50, and the No. 215 only \$3.50.

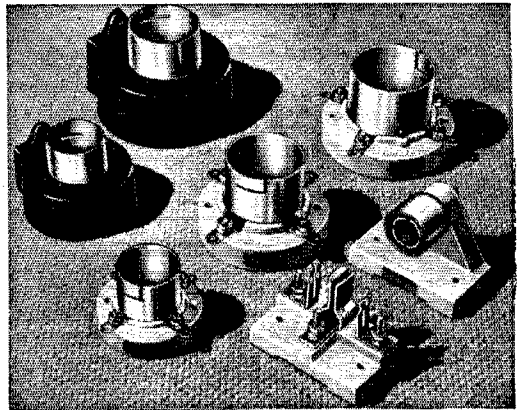

● The full Johnson line also includes porcelain Stand-off, Thru-panel, Antenna, and other Insulators; type "Q" Antennas; Plugs and Jacks; type "D" Variable Condensers; "Hi-Q" Transmitting Inductors; and other items described in Bulletin 960.

Available at usual discounts from numerous Johnson distributors

E·F·JOHNSON·COMPANY 
 MANUFACTURERS OF *Radio Transmitting Equipment*
 ● WASECA · MINNESOTA · U.S.A

Export Office:
25 Warren St., New York

Cable Address:
"Simontrica"

ASTATIC

CRYSTAL MICROPHONES AND PICKUPS

Guaranteed instruments, known for their quality, dependability and ruggedness. Extensively used in both Professional and Amateur fields. Send for your literature today!

ASTATIC MICROPHONE LABORATORY INC., YOUNGSTOWN, OHIO

"Quicker than a Short circuit" **LITTELFUSES**

INSTRUMENT LITTELFUSES, for meters, 1/200 amp. up. HI-VOLT. LITTELFUSES for transmitters, etc. 1,000, 5,000 and 10,000 volt ranges, 1/16 amp. up. Neon Voltage Fuses and Indicators (Tattellites), 100, 250, 500, 1,000 and 2,000 volt ratings. Fuses for Aircraft, Auto, Radio and Fuse Mountings, etc. You will want to know about all these products — *get new free catalog — write*

Littelfuse Labs., 4246 Lincoln Ave., Chicago, Ill.

New **MICA CONDENSERS** 
Compact
 ENCASED IN PORCELAIN

"HAMS" A Real Low-Loss . . . Leak Proof . . . Moisture Proof . . . Excellent Power Factor Condenser. Truly a remarkable Engineering achievement accomplished after many expensive and painstaking experiments. Really a precision unit at even a lower price than most ordinary condensers. Available in 2 1/2% capacity tolerance and 5000 Volt construction. Write for catalog sheet and color Chart.

AMAZING QSL OFFER — SEE HAM-ADS

See your nearest Jobber or write direct to:
FILTERMATIC MANUFACTURING CO.
 Tacony, Philadelphia, Penna.

Radio Engineering Complete in Telegraphy-Telephony



Studio Technique and Transmitter Operating Experience Guaranteed

K P A C
500-Watt 1260 Kilocycles

IN 3 to 7 months we train you to secure Commercial Telegraph Second-class, and Radiotelephone First-class government I. licenses. Course consists of Wireless Code, Radiophone, Microphone-Studio Technique, Service, Police, and Aeronautical Radio. We are authorized to teach RCA texts. At completion of course you receive practical studio technique experience in our commercial broadcast studios located in administration building, and experience as an operator on K-P-A-C (500-Watt Commercial transmitter located on the campus and owned and operated by the college), and WPA, 4000-Watt Commercial Wireless Station. If interested, write for Bulletin R.

PORT ARTHUR COLLEGE Port Arthur (world-known port) Texas

Now ... TURNER

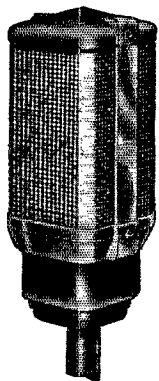

COORDINATED CRYSTAL EQUIPMENT

★ Turner now offers a complete line of amplifier equipment for the Amateur, Broadcast and Public Address operator. Every unit is engineered to realize the maximum possibilities of Turner Crystal microphones. A complete line-up of stands, cable and connectors are also available.

WRITE NOW FOR DESCRIPTIVE LITERATURE

Licensed under Patents of the Brush Development Co.

THE TURNER COMPANY
CEDAR RAPIDS, IOWA, U.S.A.

RADIO

ENGINEERING, broadcasting, aviation and radio telegraphy and telephony. Morse telegraphy and railway accounting taught thoroughly. Engineering course of nine months duration equivalent to three years of college radio work. School established 1874. All expenses low. Catalog free. DODGE'S INSTITUTE, Day Street, Valparaiso, Indiana

IMMEDIATE DELIVERY ON THE NEW
**RCA AMATEUR CW-PHONE
TRANSMITTERS**

LOW DOWN PAYMENT—CONVENIENT TERMS

DELAWARE RADIO SALES CO.
405 DELAWARE AVE., WILMINGTON, DEL.
WILLARD S. WILSON—W3DQ

**Remember
ESICO — A
REAL HE-MAN
SOLDERING IRON**



**ELECTRIC
SOLDERING
IRON CO., INC.**
342 West 14th Street
New York, N. Y.

keep the ball rolling. Plenty more are needed, however, especially to stick along with the band when conditions are poor. If you're sick of QRM on other bands we can promise you plenty of room on 28 mc.!

—G. G.

28-Mc. Calls Heard During October

ZS1H—Worked: w1df w1avv w1cmx w1ss w1gsh w1sb w1dse w1zi w2tp w2bcr w2gjb w3bph w3dlb w3fmr w3byf w3bwb w4efe w4agp w4mr w4ajy w5afx w6iju w7amx w7avv w8dyk w8tk w8cra w9bvi w9ny w9haq w9bqm w9ghn w9cox w9abe w9lf w9ij ve3du g2hg g5wp g2yl g5fv g6dh g5by g6wn g6lk g2pl g6cl on4ac on4au on4jb f8vs f8ox f8ef f8ct f8cp f8wk f8kpf d4mdn d4oon d4jmk d4arr d4gwf pa0qq pa0as ok1aw ok2ak ok1aa oe6ok j2hj lulep lu3dh fa8ih fa8cr vk6sa vk4bb vk4ap; heard: w2dsa w2fdl x1ay g6uf f8kj j2is j3fj v6eah py2qd.

W4AGP—Worked: ok1aa g2pl x1aa oklaw x1ay lulep lu9bv g5by g6cl e18b f8rj g2yl zt6k pa0fx g2hg f8tq hb9j f8ef d4nwr d4auu zs1h pa0as fa8cr fa8ih g6dh d4kpf d4arr f8vs f8ct on4au g2yl d4gwf oa4j g5fv d4ort f8ps; heard: pa0qq g6nf ea4ao f8wk g6lk k5af lu7az cx1cg g6rv d4lwm d4lwn f8vo on4ac on4jb f8cp on4nc ok2ak g6gs g5so lu3dh ti2rc x1g j3fj vk3yp z13aj vk4ap py2qd py5ag ea4av g6wp g2mg x2c x1cs cplac pa0zk.

W8CRA—Worked: ok2ak d4auu zs1h e18b vk4bb vk4ei vk5wj vk6su vk2ls vk3yp j3fj (?) g6lk d4kpf on4au ok1aa pa0as d4gwf f8vs g6nf g5la on4jb f8ct vk4gk vk4ap vk4yl su6p fa8cr oklaw g5by f8wk u8vo lulep x1cm fa8ih mia; heard: d4ort hb9j ym4aa ea4ao d4arr.

W9NY—Worked: g2yl d4gwf x2c vk4gk vk2ls pa0qq g2mv vk4ap vk2ls vk4ei cx1cg z12gq x1cs f8vs fa8ih f8os d4lrm vk4bb x1ay d4arr fa8cr on4au zs1h; heard: sulsg pa0as g6dh g6nf d4kpf g2nh oa4j vk3lx on4jb on4ac g6lh g2pl f8wk f8ct uoli su6p eplac vk3bd lu3dh em2do vk3yp vk4ei vk4ap vk2hz lulep lu3dr.

W6EWC: f8vs g5bo zs1h py2qd hi7g oa4j lu3dh lu3dd lulep z13aj z1lgx j3fj j2hj w1kv vk4bb vk4ap vk3yp vk3kx vk3bq vk3bd vk2hs vk2ls k6ewq k5ag k5ac x2r x2l x1g x1cm x1c x1ay x1am.

W6DIO—Worked: vk2ls vk2hg vk3yp vk3kx vk3bd vk3bq vk4bb vk4ap vk6su vk5hg x1ay x2c lulep j2hj z1lgx z12gq; heard: j2is j3fj em8sh lu9bv k5ac vk2hf zs1h k6ewq z1led x1cs.

W1AVV—Worked: lulep zs1h d4arr on4au d4oon d4kpf f8ox d4lta fa8ih g2hg f8vs f8vo lu9bv pa0as g2yl g6gs fa8cr pa0qq oklaw g5by on4ac g6nf vk2ls; heard: g2pl g6wk su6p f8kj g6dh f8rj eplac lu3dh cx1cg f8wk pa0fx d4gwf e18b zt6k vk3yp d4lwm g6lk d4auu f8ef oz9q sulsg g6vp g6qa ok1aa on4pa.

W2GJB—Worked: x1ay lu3dd lulep f8ct f8vs g2pl g2yl g5oj oa4j zs1h su6p d4auu d4kpf oklaw ok2ak cx1cg pa0as vk2ls fa8cr fa8ih on4jb; heard: x1cs x2c lu3dh f8kj f8ts f8wk g6nf eplac hi7g zs2j d4arr d4auo d4ort ok2ff vk2hf vk6su ea4av on4au vk2hj.

W4MR—Worked: d4arr f8wk pa0as f8os x1aa x1cs vk4ap oa4j f8rj g6dh g2pl g5wp g5fv on4ac pa0px vk4bb x2c zs1h g2hg g6xn d4kpf g5by f8ef pa0qq f8vs lulep; heard: x1gc x1ay k4kd ok1aa ce2ii f8kj g6wy.

G2PL—Worked: w1ah w4auu w4agp w6cal w7amx zs1h vk2ls w1df w1dse w2gjb w5ql w9ij zt6k; heard: w1avv w2fdl w3atf w5afx w8cra w9lf.

HB9J—Worked: w4agp w4auu w1dse; heard: w4cyi w4cfj w1gsh w2fdl w6cal w8cra.

W5WG—Worked: e18b fa8cr fa8ih g6gs g6lk ok2ak pa0as vk2ls vk3bd vk3yp vk4bb vk4ap vk4ei vk5hg vk6su z1lgx z13aj zt6k; heard: zs1h x1g x1ay vk2hf vk2as on4jb oa4j ny2ac hb5pa k4kd k5aa k5ag g5by g2mv f8ox d4kpf ea1bc.

VE3DU—Worked: on4jb on4au d4arr g2mv zs1h x2c fa8cr fa8ih g2yl; heard: f8vs f8ef f8ct lu3dh oklaw on4ac g6if g5by g6wy g5fv cx2g vk2ls vk3bd lu9bv eplac x1cs x1aa lu7as f8kj f8wk on4nc.

W9HAQ: zs1h vk2ls vk4ap lulep ea4ao g6dh g6cl oklaw g5fv g5by g6wy g5la e18b on4au fa8cr fa8gt x1ay x1cs x1am x1c d4arr lu3dh z1lgx z1gq f8wk vk5hg.

NORTHERN OHIO LABORATORIES

XMAS SPECIALS
RCA 852 now \$16.40

**CATHODE-RAY
OSCILLOGRAPH**
RCA Type TMV-122-B. Complete
with tube, \$84.50.

PEAK PRESELECTOR
Two Stage, Net. \$19.80

PATTERSON PR-16
Black Cabinet Models Complete
STANDARD, Net. \$95.70
CRYSTAL, Net. \$101.70

**NATIONAL CABINETS
PLAIN AND PUNCHED**
C-SRR...\$2.10 C-PSK...\$3.60
C-FB7.... 4.20 C-SW3.. 3.30

**WHAT'S
A
MUGAWUG?** New Mac-Key
\$7.95
Speed-x bug
\$5.70

Heavy Duty 866's, Each... \$1.29
80-160 X Crystals..... 1.50
Bliley BC2 Holders..... 1.00
Isolantite Top 210's..... 1.14
Crackle finish black paint, 1/2 pint,
\$5.69

METAL TUBES
ALL TYPES IN STOCK

Branches in following Ohio cities—
CAMBRIDGE, SHELBY AND SPRINGFIELD

NATIONAL RECEIVERS — IN STOCK —

FB7A FBXA ACSW3 SRR AGSX
\$37.50 \$51.90 \$19.50 \$19.50 \$123.00
ABOVE ARE NET PRICES LESS COILS AND TUBES

NEW RCA AMATEUR TRANSMITTERS AND TRANSCEIVERS

Amateur net prices, f.o.b. factory, for the various units and assemblies are given below. Prices are subject to change or withdrawal without notice. Prices are less tubes, crystals, microphones, and all other accessories except one set of coils for one amateur band.

NET PRICES TO AMATEUR

ACT-40 (Complete phone and CW transmitter)..... \$235.00
ACT-40-A (Antenna Unit)..... 37.50
ACT-40-R (R-F Unit)..... 110.00
ACT-40-M (Modulator Unit)..... 84.50
ACT-40-C (Metal Cabinet)..... 20.75
Extra coils for 40 watt transmitter, per set..... 7.50
ACT-200 (Complete phone and CW transmitter)..... 475.00
ACT-200-A (Antenna Unit)..... 49.50
ACT-200-P (R-F Power Amplifier Unit)..... 99.50
ACT-200-M (Modulator Unit)..... 99.50
ACT-200-S (Power Supply Unit)..... 96.50
ACT-200-C (Metal Cabinet)..... 34.50
Extra coils for 200 watt transmitter, per set..... 7.50
ATR-219 — Transceiver complete, less accessories.... 19.95

WRITE FOR NEW NATIONAL CATALOG TODAY
MAIL IMMEDIATE DELIVERY ORDERS



**RCA
IN STOCK**

800.....	\$10.00
801.....	4.50
802.....	3.90
803.....	38.50
903A.....	17.50
211.....	17.50
838.....	18.00
841.....	3.25
845.....	20.00
866.....	2.25
866A.....	5.00
852.....	16.40
860.....	35.00
865.....	12.75
885.....	2.00
906.....	18.00
954.....	5.80
955.....	3.75

SEE OCT.-NOV. QST AD'S

Sockets 4, 5, 6 prong, Each.. \$0.7
Coil forms 4, 5, 6 prong, Each. .21
Two button mike, Each..... 3.73
Single button mike, Each..... 1.76
Tubes, types 80, 26, Each... .34
Tubes 30, 56, 27, 45, 71A... Each
\$.39
Tubes 38, 82, 83, 57, 58, Each
\$.51
Tubes 41, 47, 24A, 5Z3, Each
\$.51
Tubes 2A5, 46, 77, 78, 19, Each
\$.56

**NATIONAL
HRO** \$167.⁷⁰

NORTHERN OHIO LABORATORIES
2073 WEST 85th STREET, CLEVELAND, OHIO

RCA ACR-136
NET \$69.50

You Need These Books

How to Become a RADIO AMATEUR

*Your introduction to
amateur radio*

The standard elementary guide for the prospective amateur, giving, in simple terms, complete constructional information for an inexpensive station with the necessary dope on operating practices.

E A C H
25c
POSTPAID

The Radio Amateur's LICENSE MANUAL

*Gives you the dope
that you need*

Nearly 200 typical license exam questions and answers, where, how and when to apply. In fact, all the dope on amateur licensing procedure as well as the text of the regulations and extracts from the basic radio law.

AMERICAN RADIO RELAY LEAGUE, INC.

WEST HARTFORD, CONNECTICUT

NEW . . .

**THE IMPROVED 5 AND 10 METER
DUPLIX TRANSMITTER-RECEIVER**

*Fixed
or Mobile*
**Type
TR-6A6
De-Luxe**

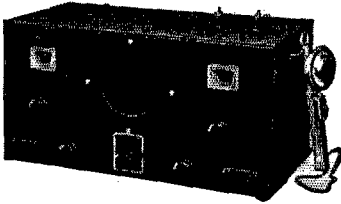

TRANSMITTER . . .

- Unity coupled p.p. oscillator using 6E6, 6A6 or 53 twin-triodes, carrier 7-10 watts. 25% **GREATER OUTPUT WITH NEW TYPE 6E6.**
- Class B modulation; 6A6 or 53. U.P.O. 10 watts.
- Class A driver using 6A6 or 53.
- Jacks for microphone and key. (No external batteries or tone needed for phone or I. C. W.)
- Plate voltage panel control switch.

RECEIVER . . .

- Tuned r.f. stage using 78 or 58.
- Super regenerative detector, 76 or 56.
- Audio driver, 76 or 56. Phone jack.
- Panel volume and regeneration controls.
- Pentode output with 42 or 2A5.
- Integral 5 inch dynamic speaker.

\$39⁷⁵

Net to
Amateurs

COMPLETE TRANSMITTER RECEIVER \$39.75

Tubes for above \$4.27
Coils for extra band \$2.50; plug-in \$7.50 installed
Universal damped hand-mike \$5.00

POWER SUPPLY . . .

- 110 volt 60 cycle supply—class B swinging and output chokes, 300V at 200 m.a.; 6.3V at 3.4 amps. and 2.5 volts at 10.75 amps. Complete with cables, plug, pilot lamp and 5Z3 rectifier tubes \$25.53. ● 6/250 V. Dynamos for Mobile Installations. *Write for Bulletin C*

RADIO TRANSCIEVER LABORATORIES
8627-115th Street Richmond Hill, N. Y.

LEARN RADIO

New Classes Now Forming! Send for 40-page catalog, explains fully. 300 licensed graduates placed in past 4½ years in broadcasting, shipping, police radio, aviation, etc. We teach all branches. Oldest, largest and best equipped school in New England. Equipped with Western Electric sound and broadcasting equipment and RCA marine transmitter. Course prepares for United States Government telegraph or telephone license.

MASS. RADIO SCHOOL, 18 Boylston Street, BOSTON

BELIEVE IT OR NOT—PROMPT DELIVERY ON

1936 PATTERSON PR-16

DOWN PAYMENT ONLY \$30.00

DELAWARE RADIO SALES CO.

405 DELAWARE AVE., WILMINGTON, DEL.

WILLARD E. WILSON—W3DQ

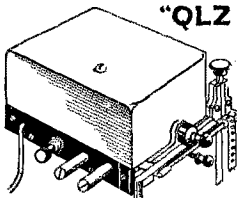

**"QLZ - QLZ - QLZ - QLZ"
OPERATORS
Save Your Fists
With the
AUTOMATIC
ROBOT
RADIO KEY**

Repeats calls or messages indefinitely, automatically, by motor-driven endless paper tape, perforated, dot and dash, by attachment on key. Length tape unlimited. Speed adjustable. Motor no influence on radio because induction-type, no brushes. A practical instrument. Answers long-felt want of amateurs or professionals.

Price
\$10
Postpaid

GUARANTEED with Full Instructions
A Splendid Gift for the Radio Ham
Made by Manufacturer of Electrical Instruments

Gardiner-Levering Co. Haddon Heights
New Jersey

W3FAR—Worked: lulep vk2ls d4kpj fa8cr x1ay j2cl lu9bv f8ox on4au f8vs fa8ih d4arr st6k pa0qq d4auu; heard: vk3yp zsh d4lnm pa0zk pa0sd g2ax g2hg lu3dh.

W2FDL—Worked: fa8cr g6dh fa8ih f8ct on4au g2pl d4kpj zsh vk2ls f8vs f8ox d4arr g6lk fa8ca; heard: x1ay f8ef pa0qq ok1aa pa0az g5fv f8wk on4jb.

W9GHN—Worked: d4pkj f8ct fa8cr lu7az vk2ls vk4gk x1aa zsh d4arr f8vs x1ay lulep; heard: lu9vb sulsg x1cx x2c su0p lu3dx on4au.

W4AJY—Worked: vk4ap vk4bb vk3yp pa0ax d4ort ok1aw st6k z13aj d4arr fa8ih ei8b vk2ls d4kpj on4au f8vs fa8cr x1ay; heard: hi7g k4ddh k5aa k4sa vk3bd vk2hf zsh1 f8ox g5fv g6ga.

W8FDA: x1ay x1aa x2c x1cx d4arr fa8ih f8ct f8wk g5la g5nf ei8b ok1aa on4ac pa0az vk2ls zsh1 vk3bd vk3yp on4au d4kpj f8ox f8vs f8ef pa0qq g2hg g6dh g5by g2hb.

W1ZI—Worked: cx1cg d4arr ea4ao fa8cr fa8gt fa8ih f8ct f8ox f8wk f8vs g2mv g2yl g6dh lulep on4ac on4au pa0ax zsh zu6p; heard: st6r zulc x2c vk4bb lu3dh g6lk g6ga g5by f8rj f8kj ei8b e85f d4kpi.

W1CSR—Worked: x1ay x2c f8ox f8vs on4au d4lnm g5yl fa8ih fa8cr ok1aa lulep; heard: py2qd hi7g co6om f8wk f8ct f8ef d4auu d4arr pa0ax pa0qq st6k zsh g2hg ok1aw ok2ak lu3dh lu9bv.

W3SI: on4au on4ac pa0qq f8ct ok2ak ok1aa g5by hb9y g2hg f8vs on4fe ok1aw fa8ih zsh x1ay lu7az lulep lu9bv lu3dd lu3dh oa4j.

W3BVN—Worked: ei8b g2nv g5la on4au; heard: x2c x1cx k4kd g2hg cx1cg zsh pa0fx pa0qq on4ac lu3dh g6wy g5fv g5by fa8cr d4kpi.

W9DHN: vk4bb vk4ap d4arr f8ox vk3bd vk3yp vk2hs vk2ls lulep cplac g5by ei8b fa8cr g2yl d4gwf g6nf f8va g2pl zsh1h.

W8MWL—Worked: vk2ls f8wk g5by d4lnq on4au x1ay x2c; heard: cm2do k5ac vk2wt g6qy pa0fx d4kpj d4arr lulep zsh voli pa0qq x1aa x1cx.

W1DF—Worked: zsh1 x1ay lulep on4au f8ox d4arr d4kpi f8vs ok2ak d4oon d4auu d4lnm g2mv on4jb pa0ax pa0qq g6dh fa8ih fa8cr f8vo g5by g2hg g2yl on4nc d4gwf zu6p zulc oa4j x1cx sulsg g6wy g2pl f8ct; heard: co6om hi7g z13aj pa0sd lu9bv cm8sh g6vp ea4ao g5la ok1aa f8wk cplac ei8b on4ac g6wn g6if lu7az x2c vk1f on4b g6nf g5fv k4sa fa8gt.

W1SZ—Worked: zsh1 fa8cr lulep fa8gt z13aj d4kpi; heard: x1ay k4kd ea4av k4sa hi7g lu3dh py2qd cm2wd vk2ls vk3yp d4arr f8ox f8vs f8vo oz9q pa0qq d4auu f8ef d4lnm ok2ak co6om lu3dx pa0ax.

A New Receiving System

(Continued from page 98)

receiver, idling, then has about the same amount of hiss as the conventional lower-frequency super-het but it has, into the bargain, the astonishing ability to squash ignition noise.

Just in case there should be any misunderstanding about it, we would mention that neither of these receivers is intended to represent the ultimate in the design of ultra-high frequency equipment. They are essentially experimental models built to investigate the merit of this particular approach to the receiver problem. Their operation in practice is more satisfactory than any other type of ultra-high frequency receiver we have handled and, speaking in terms of ham communication, they have permitted a very striking improvement in the Hartford-Boston 60-mc. link which has been in operation daily for more than a year.

Where to buy it

A directory of suppliers who carry in stock the products of these dependable manufacturers.

ASTATIC
Crystal Microphones and Pickups
ASTATIC MICROPHONE LABORATORY, Inc. YOUNGSTOWN, O.
Pioneer Manufacturers of Quality Crystal Products

- CHICAGO, ILL.** 833 West Jackson Blvd.
 Allied Radio Corporation
- CHICAGO, ILL.** 601 W. Randolph St.
 Pioneer Automotive Supply Co.
- CHICAGO, ILL.** 901-911 W. Jackson Blvd.
 Wholesale Radio Service Company, Inc.
- KANSAS CITY, MO.** 1012-14 McGee St.
 Burstein-Applebee Company
- MINNEAPOLIS, MINN.** 1124-26 Harmon Place
 Lew Bonn Company

Super SKYRIDER

 the hallicrafters

- BUTLER, MISSOURI** 211-215 N. Main Street
 Henry Radio Shop
- CHICAGO, ILLINOIS** 415 S. Dearborn Street
 Chicago Radio Apparatus Company
- CHICAGO, ILLINOIS** 520 S. State Street
 Midwest Radio Mart
- CHICAGO, ILLINOIS** 226 W. Madison Street
 Newark Electric Company
- CHICAGO, ILL.** 901-911 W. Jackson Blvd.
 Wholesale Radio Service Company, Inc.
- FARGO, N. D.** 123 Broadway
 Dalota Electric Supply Company
- KANSAS CITY, MO.** 1012 McGee Street
 Burstein-Applebee Company
- MINNEAPOLIS, MINN.** 1124-26 Harmon Place
 Lew Bonn Company
- OMAHA, NEBRASKA** 2855 Farnam St.
 Radio Accessories Company
- ST. LOUIS, MO.** 927 Pine Street
 Gordon Radio Company
- CHICAGO, ILLINOIS** 19 S. Wells St.
 Hinds & Edgerton

E.F. JOHNSON COMPANY
 MANUFACTURERS OF

 WASECA, MINN.
 U.S.A.

- CHICAGO, ILLINOIS** 226 W. Madison Street
 Newark Electric Company
- CHICAGO, ILL.** 520 S. State Street
 Midwest Radio Mart
- CHICAGO, ILL.** 901-911 W. Jackson Blvd.
 Wholesale Radio Service Company, Inc.
- CLEVELAND, OHIO** 2073 West 85 Street
 Northern Ohio Laboratories
- DETROIT, MICHIGAN** 129 Selden Avenue
 Radio Distributing Company
- GRAND RAPIDS, MICH.** 235 Market Street, S. W.
 Radio Distributing Company
- LA CROSSE, WIS.** 131 South 6th St.
 SOS Radio Supply Co.
- MOLINE, ILL.** 1420 5th Ave.
 Bengston's Radio Store
- WINNIPEG, CAN.** 310 Ross Ave.
 Electrical Supplies, Ltd.

NATIONAL

RADIO PRODUCTS
 NATIONAL COMPANY, INC., MALDEN, MASS.

- BUTLER, MISSOURI** 211-215 N. Main Street
 Henry Radio Shop
- CHICAGO, ILLINOIS** 520 S. State Street
 Midwest Radio Mart
- CHICAGO, ILLINOIS** 833 W. Jackson Blvd.
 Allied Radio Corporation
- CHICAGO, ILLINOIS** 415 S. Dearborn Street
 Chicago Radio Apparatus Company
- CHICAGO, ILLINOIS** 226 W. Madison Street
 Newark Electric Company
- CHICAGO, ILL.** 901-911 W. Jackson Blvd.
 Wholesale Radio Service Company, Inc.
- CINCINNATI, OHIO** 633 Walnut Street
 Steinberg's, Inc.
- CLEVELAND, OHIO** 2073 West 85 Street
 Northern Ohio Laboratories

Where to buy it

A directory of suppliers who carry in stock the products of these dependable manufacturers.

DAYTON, OHIO	Burns Radio Company	140 E. 3rd Street	CLEVELAND, OHIO	Northern Ohio Laboratories	2073 West 85 Street
DES MOINES, IOWA	Iowa Radio Corporation	1212 Grand Avenue	CLEVELAND, OHIO	Cleveland Distributing Co.	1301 Superior Avenue
DETROIT, MICHIGAN	Radio Specialties Company	171 E. Jefferson Ave.	DETROIT, MICHIGAN	Radio Distributing Company	129 Selden Avenue
GRAND RAPIDS, MICH.	Radio Distributing Company	235 Market Street, S. W.	DETROIT, MICH.	Radio Specialties Co.	171 E. Jefferson Ave.
INDIANAPOLIS, IND.	State Distributing Company	316 N. Illinois Street	FLINT, MICH.	Shand Radio Specialties	203 W. Kearsley St.
KANSAS CITY, MO.	Burstein-Applebee Company	1012 McGee Street	GRAND RAPIDS, MICH.	Radio Distributing Co.	235 Market Street, S. W.
KANSAS CITY, MO.	Radio Laboratories	1515 Grand Avenue	KANSAS CITY, MO.	Burstein-Applebee Company	1012 McGee St.
MILWAUKEE, WIS.	Radio Parts Company	332 W. State Street	LA CROSSE, WIS.	SOS Radio Supply Co.	131 South 6th St.
MINNEAPOLIS, MINN.	Lew Bonn Company	1124-26 Harmon Place	PEORIA, ILL.	Klaus Radio & Electric Company	707 Main Street
OMAHA, NEB.	Radio Accessories Company	2855 Farnham Street	 <p>RCA Radiotron Division of RCA Manufacturing Co., Inc.</p>		
PARIS, FRANCE	J. C. Balouzet, De Tigny, 6, Avenue Hoche				
PEORIA, ILLINOIS	Klaus Radio & Electric Company	707 Main Street			
ST. LOUIS, MO.	Walter Ashe Radio Company	1100 Pine Street			
WINNIPEG, CAN.	Electrical Supplies, Ltd.	310 Ross Ave.	BUTLER, MO.	Henry Radio Shop	211 N. Main St.
 <p>RCA Victor Division of RCA Manufacturing Co., Inc.</p>			CHICAGO, ILL.	Midwest Radio Mart	520 S. State Street
			CHICAGO, ILL.	Newark Electric Company	226 W. Madison Street
			CHICAGO, ILLINOIS	Allied Radio Corporation	833 W. Jackson Blvd.
			CHICAGO, ILLINOIS	Chicago Radio Apparatus Company	415 S. Dearborn Street
BUTLER, MO.	Henry Radio Shop	211 N. Main St.	CHICAGO, ILL.	Wholesale Radio Service Company, Inc.	901-911 W. Jackson Blvd.
CHICAGO, ILL.	Newark Electric Company	226 W. Madison Street	CINCINNATI, OHIO	Steinberg's, Inc.	633 Walnut St.
CHICAGO, ILL.	Allied Radio Corporation	833 W. Jackson Blvd.	CINCINNATI, OHIO	Krauss Radio Stores, Inc.	111 East 5th Street
CHICAGO, ILL.	Midwest Radio Mart	520 S. State Street	CLEVELAND, OHIO	Northern Ohio Laboratories	2073 West 85 Street
CHICAGO, ILL.	Wholesale Radio Service Company, Inc.	901-911 W. Jackson Blvd.	CLEVELAND, OHIO	Goldhamer, Inc.	610 Huron Road
CINCINNATI, OHIO	Steinberg's, Inc.	633 Walnut Street	COLUMBUS, OHIO	Hughes-Peters Electric Corp.	178 N. 3rd Street

Where to buy it

A directory of suppliers who carry in stock the products of these dependable manufacturers.

DAYTON, OHIO Burns Radio Company 140 E. 3rd Street

DES MOINES, IOWA Iowa Radio Corporation 1212 Grand Avenue

DETROIT, MICHIGAN Aitken Radio Corp. 1326 E. Congress Street

DETROIT, MICHIGAN Radio Distributing Company 129 Selden Avenue

DETROIT, MICH. Radio Specialties Co. 171 E. Jefferson Ave.

FARGO, N. D. Dakota Electric Supply Company 123 Broadway

GRAND RAPIDS, MICH. Radio Distributing Company 235 Market Street, S. W.

MINNEAPOLIS, MINN. Lew Bonn Company 1124-26 Harmon Place

PEORIA, ILL. Klaus Radio & Electric Company 707 Main Street

YOUNGSTOWN, OHIO Ross Radio Company 325 West Federal Street

DETROIT, MICH. Radio Specialties Co. 171 E. Jefferson Ave.

ST. PAUL, MINN. R. R. & G. W. Bauman Co. 2168 Ann Arbor St.

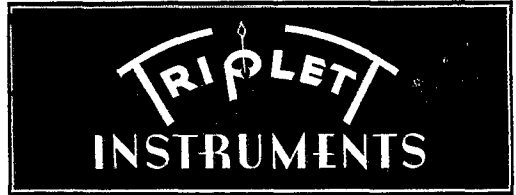

CHICAGO, ILL. Newark Electric Company 226 W. Madison Street

CHICAGO, ILL. Midwest Radio Mart 520 S. State Street

CHICAGO, ILL. Wholesale Radio Service Company, Inc. 901-911 W. Jackson Blvd.

CINCINNATI, OHIO Steinberg's, Inc. 633 Walnut Street

CLEVELAND, OHIO Goldhamer, Inc. 610 Huron Road

DETROIT, MICH. Aitken Radio Corp. 1326 E. Congress Street

DETROIT, MICH. Rissi Bros. 5027 Hamilton Ave.

FARGO, N. D. Dakota Electric Supply Co. 123 Broadway



CHICAGO, ILL. Midwest Radio Mart 520 S. State Street

CHICAGO, ILL. Newark Electric Company 226 W. Madison Street

CHICAGO, ILL. Allied Radio Corp. 833 W. Jackson Blvd.

CHICAGO, ILL. Wholesale Radio Service Company, Inc. 901-911 W. Jackson Blvd.

CLEVELAND, OHIO Goldhamer, Inc. 610 Huron Road

DES MOINES, IOWA Iowa Radio Corporation 1212 Grand Ave.

DETROIT, MICH. Rissi Bros. 5027 Hamilton Ave.



CHICAGO, ILL. Newark Electric Co. 226 W. Madison St.

CHICAGO, ILL. Midwest Radio Mart 520 S. State St.

CLEVELAND, OHIO Northern Ohio Laboratories 2073 West 85th St.

DETROIT, MICH. Radio Specialties Co. 171 E. Jefferson Ave.

FLINT, MICH. Wilke and Sessions 711 W. Dayton St.

IMPROVED! MODEL-S "GO-DEVIL"

REG. U.S. PAT. OFF.

**THE PRECISION BUILT
AUTOMATIC
TRANSMITTING
KEY**

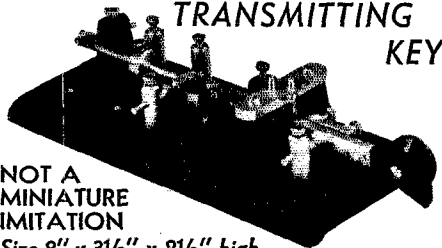

NOT A
MINIATURE
IMITATION

Size 8" x 3 1/2" x 2 1/2" high

PARTS MACHINED—NOT STAMPED

PATENTED DOUBLE LEVER DESIGN
SINGLE OR DOUBLE RATIO LEVER MOVEMENT
POSITIVE CONTACT ADJUSTMENTS
PHOSPHOR SPRING BRONZE VIBRATOR
SUPER-FLEXIBILITY
CRACKLE ENAMELED BASE-BRASS PARTS
LACQUERED

PROMPT DELIVERY
FROM STOCK

\$7.80

DESCRIPTIVE LITERATURE
ON REQUEST

ASK YOUR DEALER
BUT INSIST ON SEEING THE GO-DEVIL

GO-DEVIL INSTRUMENT CO.

263 Mill Street

Poughkeepsie, N. Y.

PANELS — BAKELITE — RUBBER — ALUMINUM
All Sizes Cut to Order BAKELITE TUBING & RODS
Drilling, Engraving & Special Work
ALUMINUM CANS—Stock sizes. Special sizes, made to order.
ALUMINUM CHASSIS—Threaded brass studs for 6/32 screws.
Length from 1/2" to 6"—price 5c to 30c.

Insulating bushings
for all size shafts



Couplings in brass
or Bakelite—15c



UNITED RADIO Mfg. Co. Est. 1923 191 GREENWICH ST., NEW YORK
Transmitting frames and racks

DURABLE
AS A BATTLESHIP



**NEW
INSULATED
Metalized RESISTORS**
IRC

Radio's most important resistor develop-
ment! Insulated against shorting—
humidity—opens—breakage. Famous
Metalized resistance principle. See
them at your jobbers. Write for catalog.



INTERNATIONAL RESISTANCE CO.

Toronto, Canada

Philadelphia, Pa.

With the Affiliated Clubs

(Continued from page 48)

directly by radio impulses from over the edge of the horizon. All battle maneuvers are possible with this radio controlled vessel.

More than one hundred amateurs were present at this meeting of the Oakland Radio Club and a vote of thanks is extended to the officers and men of the Naval Reserve for giving us a quick insight into the present workings of Uncle Sam's Navy, both ashore and afloat.

—H. J. Burchfield, W6JTV.

Get Acquainted!

Clubs are excellent places to get acquainted with radio amateurs and to participate in interesting discussions on our hobby. At A.R.R.L. headquarters there are recorded the addresses of the several hundred amateur radio clubs affiliated with the League, their places and times of meetings. Why not drop in at your local club and "meet the gang"? Address the Communications Manager (enclosing 3¢ stamp, please) for data on affiliated clubs in your vicinity.

Miscellany

The Des Moines (Iowa) Radio Amateurs Association will hold regular classes for beginners, both in theory and code. Details may be obtained from the secretary, T. S. Berry, 1615 48th St., Des Moines, Iowa. . . . The Finger Lakes Transmitting Society would like to exchange copies of its paper, "The Bug," with other club publications. Address the society at 39 Mattie St., Auburn, N. Y. . . . W3DK, secretary of the Washington (D. C.) Radio Club, writes that the W.R.C. was formerly known as the Suburban Radio Club and, according to a newspaper clipping he dug up, was founded in January, 1909! . . . The daily occupations of the new officers of the Ottawa Amateur Radio Transmitting Association are interesting! VE3PL, president, is a paleontologist with the National Museum; VE3MA, vice-president, is astronomer at the Dominion Observatory and keeps tabs on radio time signals; VE3MX, secretary-treasurer, is R.I. and interference investigator for the Dept. of Marine; VE3ABH, technical adviser, does radio engineering work for the National Research Council. The Association has obtained a club room in the Citizen Building, through the kindness of Mr. T. D. Finn, managing editor of the *Ottawa Citizen*. . . . The New Orleans Radio Club elected officers: W5JW, pres.; W5EDY, vice-pres.; W5AOZ, sec'y-treas.; W5DXK, activities mgr. The N.O.R.C. was host to Mr. and Mrs. J. L. Reinartz, W1QP, on October 16th. . . . The amateur programs from W9XAZ, 31.6 mc., continue on the schedules announced on page 45, November QST. The Milwaukee clubs are doing fine work on these broadcasts as well as obtaining regular publicity for amateur radio in the local papers. . . .

—E. L. B.

HAM-ADS

(1) Advertising shall pertain to radio and shall be of nature of interest to radio amateurs or experimenters in their pursuit of the art.

(2) No display of any character will be accepted, nor can any special typographical arrangement, such as all or part capital letters be used which would tend to make one advertisement stand out from the others.

(3) The Ham-Ad rate is 15c per word, except as noted in paragraph (6) below.

(4) Remittance in full must accompany copy. No cash or contract discount or agency commission will be allowed.

(5) Closing date for Ham-Ads is the 25th of the second month preceding publication date.

(6) A special rate of 7c per word will apply to advertising which, in our judgment, is obviously non-commercial in nature and is placed and signed by a member of the American Radio Relay League. Thus, advertising of bona fide surplus equipment owned, used and for sale by an individual or apparatus offered for exchange or advertising inquiring for special equipment, if by a member of the American Radio Relay League takes the 7c rate. An attempt to deal in apparatus in quantity for profit, even if by an individual, is commercial and takes the 15c rate. Provisions of paragraphs (1), (2), (4) and (5) apply to all advertising in this column regardless of which rate may apply.

Having made no investigation of the advertisers in the classified columns, the publishers of *QST* are unable to vouch for their integrity or for the grade or character of the products advertised.

QUARTZ—direct importers from Brazil of best quality pure quartz suitable for making piezo-electric crystals. Diamond Drill Carbon Co., 719 World Bldg., New York City.

METER and microphone repairs. Low prices. Estimates free. Quick repair service—broadcasting equipment, all electrical instruments. Sound Engineering Corp., 2200 Kinzie, Chicago.

RADIO engineering, broadcasting, aviation and police radio, servicing, marine and Morse telegraphy taught thoroughly. All expenses low. Catalog free. Dodge's Institute, Byrd St., Valparaiso, Ind.

ENGRAVING instrument panels exclusively since 1925. A. L. Woody, 189 West Madison St., Chicago, Ill.

NATIONAL—Hammarlund, Patterson used sets, 60% off list. W3DQ, 405 Delaware Ave., Wilmington, Del.

QSLs, W2SN, Helmetta, N. J.

.00035 variable condensers, 3 for \$1. W8RW, Bluffton, Ohio.
24/1500 dynamotor 350 watt. 750 volt tap, with extension shaft. Run 5 hours. Cost \$43. Sell for \$25. prepaid. M. C. Adams, Sheldon, N. Dak.

150 QSLs, two color, one buck. Mitchell, W5AIA, Watonga, Okla.

CRYSTALS—Y cut. 160-80. Within 5 kcs. \$1. postpaid. W9JKN, 2030 Montrose, Chicago.

W8GDC selling out. Stamp for list. Want generator and engine. Lieut. Jeffrey, McKee, Ky.

1500V 2 mfd. condenser, unused \$1.50. Velocity mike with input and output transformer \$13—Vibroplex \$5.50, 150 watts—160 meter fone-class B modulation—5 meters—rack and panel—very compact and commercial looking. Separate power supplies—built specially. Broadcast quality—with mike. Sam Sydorick, 535 Nepperhan Ave., Yonkers, New York.

QSLs, free samples. Printer, Corwith, Iowa.

FOR sale: Medium and high power transmitting apparatus. Two 852s, 500 v. mg set oil condensers. Many bargains. Hosea Decker, Delaware, Ohio.

FOR sale. Rack and panel C.C.-46 P.P. final xmtr. 4-tube S.W. receiver, 500 volt d.c. generator. Apply VE4UV.

TRANSMITTER wanted—Collins; Marine or rack and panel homemade. 160 meter phone not less than 100 watts. George Norton, Athens, Georgia.

BLILEY crystals. Eimac tubes, Triplett meters, order from W8DED.

QSLs! SWLs! Made-to-order!! Samples? (stamp) W8DED, Holland, Mich.

SPECIAL combination offer. One guaranteed 80 meter Xtl (X-cut within 3 Kcs.) and 200 two color modernistic QSL cards, both for only \$2.50. Articles sold separately \$1.50 each. W3AFW, Allentown, Pa.

D.C. four tube signal single super with crystal, Hammarlund coils, brand new, good condition. Complete except batteries. Best offer gets it. W6HTL.

POWER transformer Westinghouse 1½ kw. RCA power amplifier, dynamic speaker, phono-motor, pick-up. 7 tube Crosley a.c. and Airline d.c. broadcast receivers. Current transformers giving 2.75 volts 1000-1500 amps. Want cash, guns, receiver. W9FUN, 715 South 2nd Ave., West, Newton, Iowa.

SELL, swap National Radio Institute course advanced radio servicing; also unused Communications Course. W1EFW, Melrose, Mass.

FIRST ten dollar money order takes slightly used dependable 304 tube tester. Vance Haynes, Marion, Kentucky.

QSLs with your photograph. Hundred, 90¢. Samples. W9DGS, Jamestown, N. Dak.

QSL cards, two color, cartoons, message blanks, stationery, snappy service. Write for free samples to-day. W1BEF, 16 Stockbridge Ave., Lowell, Mass.

ELEVEN hundred pages, accurate, practical "hot" technical and operating dope for \$2.50 (2200, \$4.00) in new, bigger, better "R/9". Send dollar bill for five issues trial. Amplified technical staff includes Jayenay Hawkins, Kruse, Smith, Gordon, Perrine, others. Enlarged; new departments; calls heard; etc. "R/9", 7460 Beverly, Los Angeles.

QSLs. Finest, colorful. Free samples. Maleco, 1512 Eastern Parkway, Brooklyn, New York.

OSCILLOSCOPE neon tube, \$4., as described in Oct. '35 *QST*, page 48. Cathode ray results. W6CQH.

TRADE: Emerson 600 volt motor generator either AC or DC drive—handles 47-46-10 and PP10's with ease. Also Martin six string mahogany guitar with case. Cost \$50. Want Weston meters—high power xmitting components. Satisfaction guaranteed. W2GZU.

TELEPLEXES, Omnigraphs, Vibroplexes, meters, receivers, transmitters, bought, sold, exchanged. Ryan Radio Co., Hannibal, Mo.

CRYSTALS: Zero cut. Guaranteed to compensate at near zero without oven control. Your approximate frequency, 80 or 160 meters \$1.85. Ordinary zero cuts \$1.35 postpaid. Blanks 65¢, plug-in holders 75¢, dozen \$6. Fisher Laboratory, 4522 Norwood Street, San Diego, California.

CW or fone transmitter, receivers, transformers, modulator unit, power transformers. 412 W. Lincoln, Blackwell, Okla.

FOR sale 2-Western Electric 212D, class 2 \$12. each. Guaranteed. R. Earnstein, 3073 Edgehill Rd., Cleveland Heights, Ohio.

SELL complete 500 watt fone, Oscilloscope, 18 watt PA outfit, three large power supplies. Need large tubes. W5EFV, Alva, Oklahoma.

WANTED—Master Teleplex cash—W3ELN.

GENERAL Electric Dynamotors 24/750 volts 200 mills \$25, two machines for 1500 volts \$40. Westinghouse 27½/350 \$10. 6-15 volts 500 watts \$10. ¼ KW 600 cycle 110-220 volts with exciters \$10. Henry Kienzle, 215 Hart Blvd., Staten Island, New York.

RADIO (Amateur Radio's fine technical monthly) \$2. year (25¢ single) from W8DED, Holland, Mich.

HAM apparatus to sell or trade? List your swaps with us. Send for list. 110 volt a.c. relays 30 Amp. (each contact) SPST \$3.50, 2PDT \$4.50, 3PDT \$5., 4PDT \$6. Amateur Exchange, 6341 Broadway, Chicago.

SELL 1 kilowatt Thordarson 2000 volt transformer, Radio-tron 852, Vibroplex, Filament transformer, receiver, 2 147B Cardwell condensers, resistors, electrolytic condenser, 1 pair R.E.L. inductors, relay switch, Recto bulbs, filter choke. Several QST wavemeters. Many other parts. Murriel Purlee, Seymour, Indiana.

SELL, trade. 211E. John Massol, Route 9, South Hills, Pittsburgh, Pa.

SELL transformer 1600-0-1600 at 700 mils \$14. guaranteed. R. Laursenon, 812 Coal, Wilkinsburg, Pa.

WANTED extra coils for FB7 National. E. Russell Wightman, Crete, Neb.

QSLs! SWLs! Samples. W9UII.

TRADE—\$250. worth high grade ham equipment for good used car, Chevrolet preferred. W9IQW.

QSLs, 300 one color cards \$1. Samples. 2143 Indiana Ave., Columbus, Ohio.

WANTED Edison storage "A" batteries, UX852s. Grote Reber, Wheaton, Illinois.

SELLING out. W9ARE.

AGAIN—those "T-9" dependable X cut 40 meter crystals: \$1.50 within ten kilocycles, \$2. exact frequency. Postpaid. Strong oscillators; fully guaranteed. "Judge not by price but by performance." "Eidson's," Temple, Texas.

WANTED—old spark equipment, step-up transformers, quenched gaps, mica condensers. Weston milliammeters. W5KID.

W9ADN crystals. Temperature coefficient—0.000007—"V"—40-80—\$3.75; 80 "AT"—0.00001—\$2.50—0.000002—\$4. Holders \$1.

SELL new peak linear monitor, 5-200 meters, tubes, \$12.50. W6BII, 1909 State Street, Santa Barbara, Calif.

FREE folder, blanks 50¢, holders 50¢. Faberadio, Sandwich, Illinois.

CALLBOOKS—new prefixes, thousands of late W, VE and new DX calls, in the winter 1935 Radio Amateur Call Book. Send postpaid \$1.25, or a whole year (four issues) for \$4. (In foreign countries \$1.35 and \$4.35.) W9FO—610 S. Dearborn, Chicago.

NEW walnut cased d.c. multiple meter: 0-1-1-10-100-1,000 volts. 0-.001-.01-1-1-10 amperes. 0-50,000-5,000,000 ohms. Simple decimal scale, low price, precision meter for the amateur, engineer and experimenter. Schooley Engineering Company, Terril, Iowa.

HAMMARLUND Pro \$58. Speech amplifiers, racks, meters, microphones B&H projector \$50. State wants. Want long wave receiver. Al Dolan, State Theatre, Cleveland, Ohio.

REBUILT Vibroplexes \$5-7. New large base \$9. Lydeard, 28 Circuit, Roxbury, Mass.

AC-DC SW3, 20, 40, 80 bandspread, power pack, tubes. \$22.50. W6KHV.

SELL: 375 ma, 50 lb. plate transformer, 3000, 2200, 1100 volts each side, C.T.; 10 lb. fil. transformer, 10V, 7 amp., 10V, 7 amp., 2 1/2 V, 10 amp. C.T.; 40 lb. 500 ma choke, 10 and 30 henrys, 90 ohms. New and guaranteed by maker two years. Cash offer. W1BVU.

WILL sell or exchange for car a 203A six foot all steel transmitter which includes all Cardwell and Thordarson parts. Write for details or appointment. W2HZN.

MILLIAMMETERS—all brand new, triple range Jewells. W9SXF, 1237 "C" St., Lincoln, Nebraska.

1 RCA 204A—used 700 hrs.—2 RCA 849 used 1000 hrs. \$15. each. Purchased new. W4DQD, 20 NW 61st St., Miami, Florida.

TRADE—Omnigraph for late model automobile radio or miniature camera. Chas. Lapp, 152 Stewart Ave., Pittsburgh, Pa.

THREE band 20 watt crystal transmitters, power supply and crystal included \$28.75. R. Stimpson, Skowhegan, Maine.

CLASS B 203A TRANSFORMERS \$14. pair. W2GZL.

BOSTON Hams! WIAVE selling out, need cash. Apparatus, magazines, Bargains.

CRYSTALS, Y cut, guaranteed oscillators 80-160 meter bands \$1. postpaid. Herbert Addington, 2252 North LeClaire, Chicago.

SELL—FB-7, tubes, 20, 40, 160, 75 to 200 general coverage, coils. \$35. money order only. W8LRO, 3623 Belmont St., Bellaire, Ohio.

TRANSFORMERS—2000, 2500 each side—300 Mils.—\$10. 1000, 1250 each side—350 Mils.—\$6.—W3CGA.

QSLs that bring results. Samples. W2AEY.

CRYSTALS:—The finest precision methods are used in the manufacture of "HC" crystals. All merchandise unconditionally guaranteed. Send for new catalogue describing all piezo-electric products for amateur and commercial use. Ham Crystals, 1104 Lincoln Place, Brooklyn, N. Y.

INTRODUCTORY offer. One order to an individual. Send \$1. and call letters for 100 two color modern QSL cards (not filled with advertising—send for sample) and six F.M.C. porcelain case mica low loss transmitting and receiving condensers. Any capacity up to .006 mfd. 5% capacity tolerance 2,000 volt test. Actually a \$7.50 value for \$1. Capacity color chart included. Filtermatic Mfg. Co., Tacony, Phila., Pa.

GUARANTEED crystals, 160-80 meters. Exact specified frequency, 1" square \$2.75 within 15 kilocycles of specified frequency, and less than 1" \$1.35. Within seven kilocycles, approximately 1" \$1.75 X or Y cut. Exact frequency marked on each crystal. William Threm, W8FN, 4021 Davis Ave., Cheviot, Ohio.

TRANSFORMERS—1200 watt 1200-2200-3200 each side \$32. Quotations given. Frank Greben—W9CES, 1533 S. Sawyer Ave., Chicago, Ill.

SNAPPIEST station in town—looks like a million, sounds like a million. Built on the new all-welded relay racks, chassis, panels. Powered with QST specification variable voltage power equipment. Edison B. Rectifier Engineering Service, 4837 Rockwood Rd., Cleveland, Ohio.

SWAP or sell Baird cathode ray tube, separate power supply time axis generator, Jewell 209 tube checker to 5 prong tubes. Pilot AC Super-Wasp, coils, no power supply. Gross class B transformers for 4-48s. Remington model 10 typewriter. Bud condenser microphone with preamplifier on floor stand. Four AC voltmeters 0-4/8/40. Four 0-2 Ampere RF. Two REL 20 meter coils. 1100 volt CT 400 MA plate transformer. Want modern analyzer, frequency modulator. W2EDW.

RCA photophone speaker, high sensitivity, Lafayette Field Supply, guaranteed perfect, \$6. A real buy. W2EXR.

QSL moderately priced three color cards of distinction. Entirely different. We imprint your name and address free. Write for sample. Johnson City Publishing Co., Johnson City, N. Y.

RECEIVERS—new and used, sold and traded in. Hammarlunds, Nationals, RME9D, Sky rider. Schwarz Radio Service, 15 Lawrence Ave., Dumont, N. J.

FOR sale. Six 750 volt, 150 watt generators, \$11. each. Also a few other generators and motors. Wilmot Auto Supply Company, 1970 Wilmot St., Chicago.

AUTOMOBILE call letter plates. 85¢ pair. W9AIN, Evansville.

SELL: National general coverage coils FB A, FB B, FB C, FB D, FB E, \$3. a pair. Have over fifty pairs. Guaranteed WE276As, \$7.50, WE251As, \$50. Silver 10F transmitter, complete, \$65. W9ARA, Butler, Mo.

RCA—860's—pair (new). Also Thordarson transformer, type 2209—3000 volt c.t., 900 ma. Reasonable for cash. Make offer. W4AKY.

CLASS B transformers—Universal for two or four 46s, 210s, 800s, RK18s, etc., \$7.75 pair postpaid. 70 watts audio from 46s, 100 watts from 10s. Write for details. W8UD, Douglas, Mich.

852—\$12, 849—\$15, used RK20—\$8, new RK20—\$10, 3500 V bavarian condensers, 75H—500 MA. modulation choke. Filament and plate transformers cheap. W3ASK.

TRADE—High grade amateur and commercial equipment, parts, A cut crystals, new broadcast receivers; for Graflex series two, Leica, Contax or other high grade cameras. No junk wanted and no junk offered. Herb Hollister, W9DRD, Merriam, Kansas.

A Dependable Power Supply for PORTABLE TRANSCEIVERS

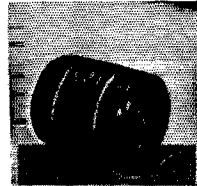

Five- and Ten-Meter Fans find Pioneer Model "E" Dynamotor makes the ideal power supply for their portable sets. Input 6, or 12 Volts, output 200 Watts, 1000 volts at maximum output. Write for full information on Dynamotor and the new Gas Engine Driven Generators.

PIONEER GEN-E-MOTOR CORP.
462A W. Superior Street CHICAGO



So MUCH for so little!

Popular product . . . extraordinary demand . . . mass production schedule . . . marked economy . . . lowest price. That's the reason for a genuine oil-filled X-mitting Condenser at give-away price.

- Pure linen paper dielectric . . . reinforced winding prevents plate flutter.
- Oil-impregnated sections . . . oil-filled hermetically-sealed metal container . . . cool operation.
- High tension pillar terminals . . . conservative ratings . . . maximum service life.
- 1000, 1500 and 2000 v. ratings.

New Catalog just issued. Covers complete condenser and resistor line. Also sample copy of Research Worker. Sent on request.

AEROVOX

CORPORATION

73 Washington Street • • Brooklyn, New York

Your Nearest Dealer Is Your Best Friend

Your nearest dealer is entitled to your patronage. You can trust him. He is equipped with a knowledge and understanding of amateur radio. He is your logical and safe source of advice and counsel on what equipment you should buy. His stock is complete. He can supply your needs without delay. His prices are fair and consistent with the high quality of the goods he carries. He is responsible to you and interested in you.

Patronize the dealer nearest you—You can have confidence in him

CHICAGO, ILLINOIS

Allied Radio Corporation
833 West Jackson Blvd.

Complete standard lines always in stock—W9NRV—W9IBC—W9RZI

CHICAGO, ILLINOIS

Chicago Radio Apparatus Company
415 South Dearborn Street (Est. 1921)

W9RA and W9PST—Amateurs since 1909

CHICAGO, ILLINOIS

Mid-West Radio Mart
520 S. State Street
All standard lines carried in stock

DENVER, COLORADO

Inter-State Radio & Supply Co.
1639 Tremont Place

Amateur Radio Headquarters in the Rocky Mountain Region

DETROIT, MICHIGAN

Radio Equipment Sales Co.
14036 Woodward Ave., Highland Park
A complete stock of amateur, shortwave and service parts

DETROIT, MICHIGAN

Radio Specialties Company
171 E. Jefferson Avenue
Ham Supplies—National & Hammarlund Sets and Parts

DETROIT, MICHIGAN

Rissi Brothers
5027-31 Hamilton Ave. at Warren
W8KXK Manager Amateur Department

FRESNO, CALIFORNIA

Ports Manufacturing Co.
3265 E. Belmont Ave.
Wholesale: RCA-Thordarson-Bliley. All Standard Lines

KANSAS CITY, MISSOURI

Burstein-Applebee Company
1012-14 McGee Street
"Specialists" in supplies for the Amateur and Serviceman

KANSAS CITY, MISSOURI

Radio Laboratories
1515 Grand Avenue
Amateur Headquarters in Kansas City

LOS ANGELES, CALIFORNIA

Pacific Radio Exchange, Inc.
729-31 South Main Street

Most completely diversified stock of amateur equipment in the West

MILWAUKEE, WISCONSIN

Radio Parts Company, Inc.
332 West State Street
Complete stock Nationally Known products

MINNEAPOLIS, MINNESOTA

Electric City
1607 Hennepin Street
Headquarters for standard lines of amateur and servicemen parts

SALT LAKE CITY, UTAH

Felt Radio Company
150 South Main Street
W6IAL Intermountain Radio Headquarters W6GTQ

ST. PAUL, MINNESOTA

Lew Bonn Company
2484 University Avenue
Rex L. Munger, W9LIP, Sales Engineer
Radio Wholesaler Complete Stock

SAN FRANCISCO, CALIFORNIA

Offenbach Electric Company, Ltd.
1452 Market Street
"The House of a Million Radio Parts"

TORONTO, CANADA

A & A Radio Service Supply
101 Queen Street, West
Canada's foremost radio supply house

You Are Protected When You Buy From QST Advertisers

“Advertising for QST is accepted only from firms who, in the publisher’s opinion, are of established integrity and whose products secure the approval of the technical staff of the American Radio Relay League.”

Quoted from QST’s advertising rate card.

Every conceivable need of a radio amateur can be supplied by the advertisers in QST. And you will know the product has the approval of the League’s technical staff.

For Your Convenience QST'S INDEX TO ADVERTISERS IN THIS ISSUE

Aerovox Corporation	116
Amateur Service Sales	103
Amperex Electronic Products, Inc.	78
Atlantic Microphone Company	107
A.R.R.L. Binder	97
Booklets	105
Calculators	6
Christmas Offer	89
Handbooks	83, 106
Hints & Kinks	111
Supplies	109
Birnback Radio Company, Inc.	82
Bliley Electric Company	95
Bruno Laboratories	84
Bud Radio, Inc.	104
Burgess Battery Company	77
Burton-Rogers Company	84
Candler System Company	86
Capitol Radio Engineering Institute	88
Cardwell Mfg. Corp., Allen D.	68
Central Radio Laboratories	76
Cohen's Sons, I. S.	111
Collins Radio Company	Cov. 2
Cornell-Dubilier Corp.	88
Delaware Radio Sales Co.	106, 108, 110
Deutschmann Corp., Tobe.	70
Dodge's Institute	108
Eastern Radio Specialty Company	90
Eby, Inc., Hugh H.	104
Eitel-McCullough, Inc.	92
Electrad, Inc.	103
Electric Soldering Iron Company	108
Filtermatic Mfg. Company	107
Gardiner-Levering Company	110
General Electric Company	87, 99
General Radio Company	94
General Transformer Company	71
Go-Devil Instrument Company	114
Gross Radio, Inc.	6, 119
Gulf Radio School	104
Hallcrafters, Inc., The	4
Hammarlund Mfg. Company	85
Harvey Radio Laboratories	101
Henry Radio Shop	96
Hinds & Edgarton	5
Hipower Crystal Company	106
Instructograph Company	103
International Resistance Co.	114
Jefferson Electric Company	120
Johnson Company, E. F.	107, 111
Leeds	79
Littelfuse Laboratories	107
M & H Sporting Goods Co.	94
Manhattan Electric Bargain House	75
Marine Radio Company	102
Massachusetts Radio School	110
Miller Company, J. W.	94
McElroy, T. R.	100
McGraw-Hill Book Company	74
National Company, Inc.	67, 72, 93, Cov. 3
National & State Tuberculosis Asso.	90
Newark Electric Company	81
Northern Ohio Laboratories	109
Ohmite Mfg. Company	98
Pioneer Gen-E-Motor Corp.	116
Port Arthur College	107
Precision Piezo Service	98
Premier Crystal Laboratories	103
Radio Laboratories	105
Radio Mfg. Engineers	91
Radio Receptor Corp.	102
Radio Shack	6, 101
Radio Supply Company	107
Radio Transceiver Laboratories	110
Ramsey Publishing Company	102
Raytheon Manufacturing Co.	102
RCA Institutes, Inc.	98
RCA Manufacturing Company	Cov. 4
Scientific Radio Service	96
Shuler Supply Company	111
Shure Brothers Company	82
Signal Electric Mfg. Company	100
Standard Transformer Corp.	80
Teleplex Company	92, 96
Thordarson Electric Mfg. Co.	99
Triplet Electrical Instrument Corp.	72
Turner Company	108
United Radio Mfg. Co.	114
Utah Radio Products	100
Valpey Crystals	100
Weston Electrical Instrument Corp.	69
Wright-DeCoster, Inc.	86

OUTSTANDING !!

Gross Crystal Holder

WHITE CERAMIC commercial type crystal holder—priced at less than ordinary holders. Adjustable pressure, dust proof, no tools required to open. Takes crystal to 1 1/4" square. Plugs standard 3/4" spacing. Most efficient job yet..... **\$1.00**

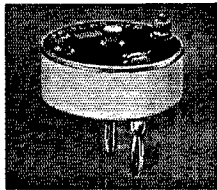

THORDARSON CASED TRANSFORMER

600 volts each side of C.T. 200 MA 2 1/2 V. 10 amps. C.T., 5 V. 3 amps. 7 1/2 V. 3 amps. C.T. **\$2.45**
 THORD. CHOKE 12 H 250 MA..... **\$1.95**
 THORD. 15 H 250 MA CHOKES..... **\$2.95**

MAC-KEY Semi-Automatic and Straight Junior Model..... **\$4.95 \$7.95**

HALLICRAFTERS SUPER-SKYRIDER

Complete with 9 Metal Tubes... **\$79.50**
 Same as above. With Crystal... **\$89.50**
 See Technical Article P. 36 Aug. QST.

TAYLOR TRANSMITTING TUBES

825 Carbon Plate 40 Watts 750 V. **\$ 4.95**
 203-A Carbon Plate..... **12.50**
 203-B Metal Plate..... **7.50**
 HD203-A Carbon Plate—out of top. **\$17.50**

STEEL AND ALUMINUM RACK PANELS

BLACK CRYSTALLIZED LACQUER FINISH

STANDARD MOUNTING 19" long 1/8" thick

Width	Standard Mounting	
	Steel Panels	Aluminum Panels
1 3/4"	\$.58	\$.75
3 1/2"	.58	1.05
5 1/2"	.68	1.35
7"	.70	1.60
8 3/4"	.95	1.95
10 1/2"	1.15	2.50
12 1/2"	1.35	2.95
14"	1.55
15 3/4"	1.75	3.75
17 1/2"	1.95	3.98
19 3/4"	2.10	4.50
21"	2.40	5.25

RELAY RACKS

Constructed of very heavy gauge steel (about 1/8" thick). Finished thruout in black Shrivel Lacquer—Complete with all panels. Panels 3/8" thick.

Type R4:— with 4 panels 8 3/4" x 19". Overall size 21 1/2" wide, 39" high. Price..... **\$10.45**

BARR DB3 TRANSCEIVER

less tubes, batteries and accessories. Bulletin on request. **\$16.20**

RCA-DeFOREST

866 Tubes..... **\$2.25**
 852 Tubes..... **16.40**

Largest stock of BLILEY CRYSTALS in New York.

BC2 Crystal Holders..... **\$1.00**
 BC3-40-80 M Mounted Crystals. **3.95**
 LD2-40-80-160 M Mounted Crystals. **\$4.80**

(Exact if in stock or within 10 KC)

NEW!! HOYT BAKELITE CASE HOT WIRE ANTENNA METER

3 3/4" Across Flange, Mounts through 2 1/2" hole. Scale Length 1 3/4". Ranges: 0/1.5; 0/3; 0/5 Amps. **\$3.50**

GROSS CASED POWER TRANSFORMERS

650 v. ea. side C.T. 350 ma. fila. 2-7 1/2 v C.T. and 1-5 v will give 500 v with choke input using 83 or 5Z3 tubes. You can run your entire R.F. and class B off this trans..... **\$5.50**
 750 v. ea. side C.T. 300 ma. fila. 2-7 1/2 v C.T. and 1-5 v..... **\$5.65**
 750-1000 v. ea. side of C.T. 300 watts. **\$6.65**
 850-1350-1500 v. ea. side of C.T. 400 watts..... **\$8.75**
 (the ideal job to give 750-1000-1250 v D.C. with choke input)
 850-1350-1500 v. ea. side of C.T. 550 ma..... **\$12.50**
 1500-2000 v. ea. side of C.T. 800 watts. **\$11.70**

GROSS CB-25 & CB-100 30 and 100 Watt

Phone-CW Transmitters

Very specially priced

Write for data on these and other Gross Transmitters

TRANSMITTING FILTER CONDENSERS

Compact, cased, with stand off insulators

1000 V.	1500 V.	2000 V.
<i>Working Voltage</i>		
1 mfd.....	\$1.10	\$1.45 \$1.75
2 mfd.....	1.45	2.00 2.45

VITREOUS ENAMELLED RESISTORS 8 3/4" x 1 1/4" with Mounting Brackets 500 ohm to 100,000 ohm. Spec. ... **\$1.49** (State Ohmage desired)

SUPREME TEST EQUIPMENT ON TIME PAYMENT PLAN

EIMAC UNSURPASSED TRANSMITTING TUBES! Performance—Ruggedness—Power—Price

50-T Output 75 to 250 watts... **\$13.50**
 150-T Output 150 to 450 watts... **24.50**

GENERAL ELECTRIC PYRANOLS

We have been appointed distributors of this famous commercial line of capacitors now available to the amateur.

	1000 V. 1500 V. 2000 V.		
	D.C.	D.C.	D.C.
1 mfd.....	\$1.78	\$2.23	\$3.12
2 mfd.....	2.67	3.71	4.75
4 mfd.....	4.16	5.35	6.53

Nickel Silver Name Plates

Black background with silver letters and border. Size 1/2" x 1 1/4". Following markings:

Gain	Speech	Doubler
Buffer	Modulator	Class-B
Amplifier	Class C	Filaments
Stand-By	Plates	Grid
Oscillator	Neutralizer	Crystal
Microphone	Antenna	Plate
	10c each	6 for 50c

GUARANTEED TUBES ISOLANTITE TOPS

800 Carbon Plate..... **\$4.90**
 866-A 10,000 volts inverse Peak. **\$1.85**
 203-A Carbon Plate..... **\$8.45**

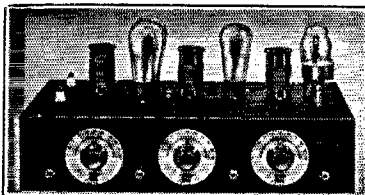

*47 as crystal oscillator, one *46 as buffer or doubler and two *46's in the amplifier stage, set of three coils supplied with kit for 20, 40, 80 or 160 band. Additional coils 75c each. Complete kit, less tubes and crystal..... **\$14.95**

P-25 POWER SUPPLY—for CW-25 transmitter with matching chassis— **\$11**
 450 volts at 200 MA, choke input—complete kit, less tube.....

20% DEPOSIT WITH ALL C. O. D. ORDERS

REMIT BY M. O. INCLUDE POSTAGE

Cable Address: GROSSINC

GROSS RADIO, INC., 51 VESEY STREET, NEW YORK CITY

JEFFERSON Presents

New Ruggedness in Filament Transformers

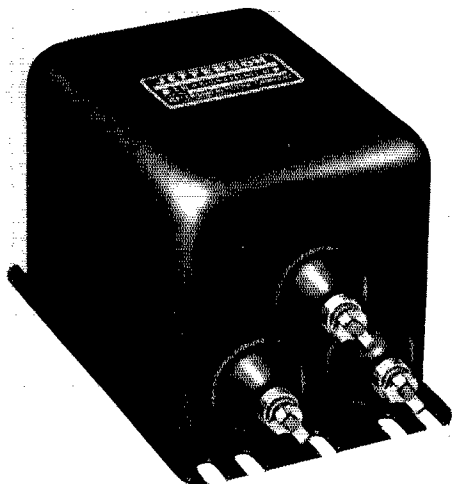

THE new Jefferson Filament Transformers are designed with such margins of safety and quality that they more than meet the requirements of the radio amateur and experimenter.

In addition to liberal design, which makes for good regulation, judicious use of highest grade mica and porcelain insulation insures long life and perfect performance under every condition of service.

Adaptability to all needs is provided by the listing of multiple secondary transformers as well as by the construction of the more popular designs in either open or enclosed style mountings.

Attractive appearance has been stressed in

design in keeping with typical quality construction throughout.

Jefferson Features include:

Full secondary voltages under load

Rigid test limits

Adequate Insulation

Conservative rating and construction which includes modern coil impregnation, varnish treatment and bake, high grade silicon steel, convenient terminals.

Write your wholesaler for the Jefferson catalog today. It includes a complete line of parts for amateur work.

JEFFERSON Filament Transformers

Catalog No.	Capacity V. A.	SECONDARY			Tubes	Size	Wt. Lbs.	Price
		Volts	Amps.	Insulation				
464-211	13	2.5 C.T.	5.25	1500	27, 2A3, 82, etc.	2 x 3 1/4 x 1 7/8	1	\$ 1.40
464-221	25	6.3 & 5 C.T.	4.	1500	80, 71, 5Z3, etc.	2 1/2 x 4 x 2 5/8	2	2.00
464-201	30	2.5 C.T.	12.	7500	82, 66, 27, etc.	2 1/2 x 4 x 2 5/8	2	2.00
464-241	70	10. C.T.	7.	5000	03A, 11, etc.	4 x 3 1/4 x 2 7/8	2	4.00
464-281	30	2.5 C.T.	12.	7500	66's, etc.	4 1/2 x 3 1/4 x 4	5	6.00
464-271	49	7.5 C.T.	6.5	2000	800, RK18, etc.	4 1/2 x 3 1/4 x 4	5	6.00
464-291	70	10. C.T.	7.	5000	03A, 11, etc.	4 1/2 x 3 1/4 x 4 1/2	6	6.00
464-261*	100	5. C.T.	20.	8000	872, 72A, etc.	4 5/8 x 8 1/2 x 4 1/2	12	16.00

COMBINATION TYPES

464-191*	64	{ 2.5 C.T. 2.5 C.T. 5.0 C.T. 2.5 C.T.	{ 1.4. 1.75 3. 3.5	1500 V.	For 59 Class "B" Amplifier	4 1/2 x 3 1/4 x 3 3/4	5	4.00
464-231	38	{ 7.5 C.T. 7.5 C.T. 2.5 C.T.	{ 2.5 2.5 5.					
464-301	50	{ 2.5 C.T. 2.5 C.T.	{ 5. 10.	5000 V.	For '66 Bridge Type Rectifier	4 x 3 3/4 x 5 3/8	6	9.50
464-251*	74	{ 7.5 C.T. 2.5 C.T.	{ 6.5 10.					

*—Has primary tap for 110 Volts

JEFFERSON ELECTRIC COMPANY, Bellwood (Suburb of Chicago), Illinois

Canadian Factory: 535 College Street, Toronto

JEFFERSON T *Radio* Transformers

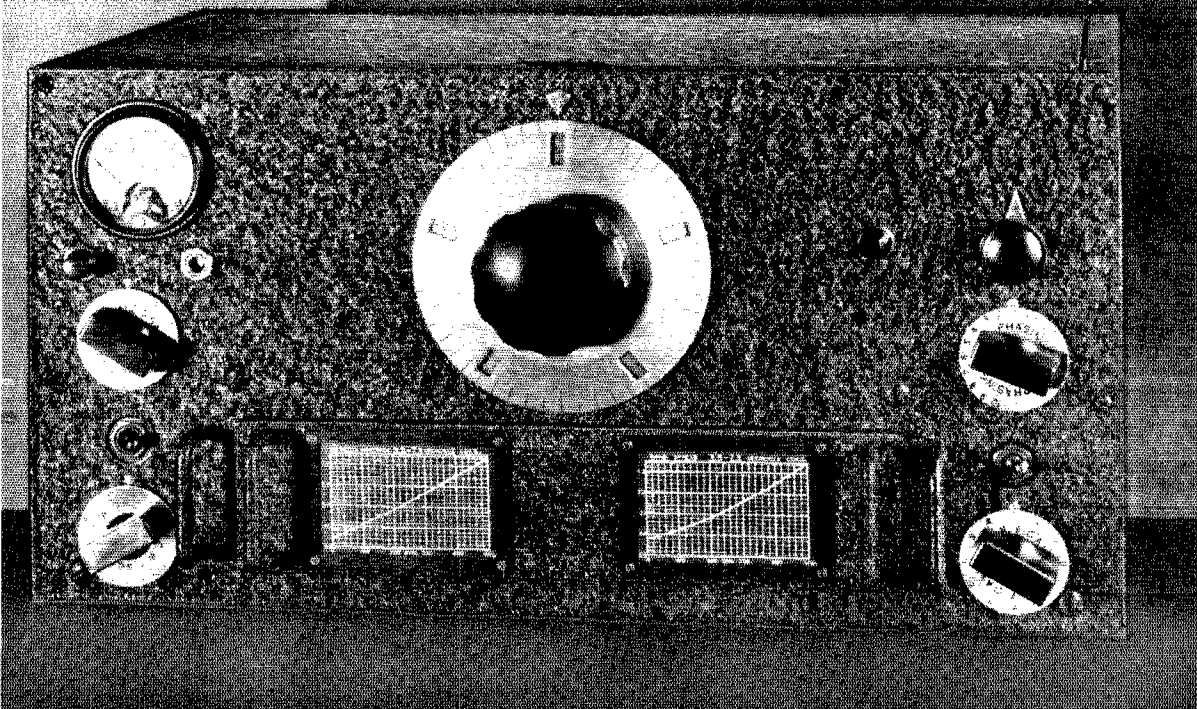

It is significant that amateurs who yesterday were complaining about QRM, now devote their rag-chews to praise of their new HROs. To these men, interference has become merely a sporting handicap, not a barrier to pleasure or DX.

For the HRO is a highly developed instrument for pulling in signals wherever you are, whenever you want to listen. Nothing was left undone that might improve this ability, no pains were spared to make it convenient and precise.

NATIONAL



COMPANY

PRICES

Reduced

RCA 852
FORMERLY \$23.80

NOW \$16.40

RCA 866
FORMERLY \$4.50

NOW \$2.25

RCA Radiotron passes on to the amateur the considerable savings now resulting from increased volume and increased manufacturing efficiency.

At the new low amateur's net price of \$16.40, the famous RCA 852 becomes an even more outstanding value than ever before. Tried, proved, and trusted in all parts of the world, this favorite is now brought within the price range of many amateurs who hitherto have felt they could not afford it.

The RCA 866 at half its former price is a truly great value. At this attractive price you can afford to use only the best. Take advantage of these new low prices now.



HIGH POWER NEVER BEFORE COST SO LITTLE

AMATEUR RADIO SECTION

RCA RADIOTRON DIVISION

RCA Manufacturing Co., Inc., Camden, New Jersey, a subsidiary of the

RADIO CORPORATION OF AMERICA

INDEX TO VOLUME XIX

1935

AMATEUR RADIO STATIONS

VE3VD, Toronto, Ont.	62, May
W1BFX, South Brewer, Maine	40, Sept.
W1FH, Everett, Mass.	50, Oct.
W2CBO, Scotia, N. Y.	45, Dec.
W2GHA, Jamaica, N. Y.	46, Jan.
W2HBK, New York City	62, May
W2HCP, Albany, N. Y.	37, Mar.
W3AAJ, Richmond, Va.	40, Sept.
W3BYK, Camden, N. J.	59, Mar.
W3DD, Ardmore, Pa.	31, Jan.
W3SI, Harrisburg, Pa.	44, June
W5DAQ, New Orleans, La.	50, Oct.
W6GHD, Walnut Creek, Calif.	45, Dec.
W6JYH, Los Angeles, Calif.	47, Jan.
W6TI, Oakland, Calif.	50, Oct.
W6USA, San Diego, Calif.	45, Nov.
W7BJS, Rock Springs, Wyo.	57, Mar.
W7BVL, Seattle, Wash.	45, Dec.
W7BYW, Buhl, Idaho	51, Oct.
W7EAN, Seattle, Wash.	61, May
W8BIH, Elmira, N. Y.	61, May
W8BQ, West Hazleton, Pa.	57, Apr.
W8EDR, Toledo, Ohio	58, Mar.
W8GHA, Harrison, Mich.	41, Sept.
W8HWR, Utica, N. Y.	42, Feb.
W9BEZ, Wichita, Kans.	57, Apr.
W9DUD, St. Louis, Mo.	46, Jan.
W9JIR, Chicago, Ill.	51, Oct.
W9KJF, Indianapolis, Ind.	42, Feb.

AMATEUR REGULATIONS AND LEGISLATION

Canadian Regulations Revised	67, May
China's Domestic Regulations Prohibit Traffic	66, Mar.
Dr. Jolliffe Discusses Cairo Arrangements	36, Oct.
Licenses	44, Mar.
License Notes	25, Nov.
New Regulations	27, Aug.
Philippine Regulations	50, June

ANTENNAS, TRANSMISSION LINES

A Garage-Top Mast (Exp. Section)	48, July
A New Antenna System for Operating Control of Radiation (Reinartz)	9, Feb.
A Space-Saving Adjustable Antenna (Eubank)	48, Mar.
Adjustable-Length Antenna (Exp. Section)	44, Aug.
An Improvement in Twisted-Pair Feeders (Graham)	22, Jan.
Correction	104, Mar.
Another Successful 56-mc. Directive Antenna	15, Feb.
Antenna Directivity (Exp. Section)	59, May
Antenna Filter for Reception (Exp. Section)	59, May
Antenna-Filter Variant (Exp. Section)	44, Aug.
Antenna Supports (Exp. Section)	74, Jan.
Changing the Antenna Directional Characteristics (Exp. Section)	49, Nov.
Doublet Receiving Antenna and Bucking Circuit for Duplex Operation (Seeley)	28, Jan.
Getting Cooperation in the Antenna System (Goodell)	16, Feb.
Guying Antenna Masts (Exp. Section)	45, Aug.
Inexpensive Feeder Separators (Exp. Section)	56, Mar.
Matched-Impedance Coupling to the Zepp Antenna (Hardin)	23, Feb.
More on the Practical Operation of Transmitting Antennas (Potter and Goodman)	21, Apr.
Raising a Sectionalized Tower (Exp. Section)	43, June
Real Results With a Simple Reflector System (Smith)	16, May
Shifting Antenna Directivity by Phase Switching (Griffin)	39, Oct.
Standing Wave Locator (Exp. Section)	30, July
The All-Around 14-mc. Signal Squitter (Mims)	12, Dec.
The V-Doublet Noise-Reducing Receiving Antenna (Crossland)	29, May

ARMY-AMATEUR RADIO SYSTEM

A.A.R.S.	44, Mar.
A.A.R.S. ZAG Contest (Coderman)	69, May

Armistice Day Message, 1934	21, Feb.
Army-Amateur Notes	37, Sept.
'One-Spot' Net Operation (Hoffman)	42, Mar.

BEGINNERS

Beginners, QRM and Restrictions (Wood)	47, Feb.
Code Practice	48, June; 49, Aug.
Code Practice Schedules	60, Nov.

BOOK REVIEWS

Fundamentals of Radio, Second Edition (Ramsey)	96, Nov.
Making a Living in Radio (Bouck)	72, Dec.
Measurements in Radio Engineering (Terman)	96, Nov.
Practical Radio Communication (Nilson and Hornung)	106, Nov.
Radio Design Practice (Millen)	76, Oct.
SOS to the Rescue (Baarslag)	88, June
The Cathode Ray at Work (Rider)	96, Nov.
Twenty-fifth Anniversary Year Book, Radio Club of America	96, May

CALLS HEARD

61, March	65, May	42, Aug.	47, Dec.
-----------	---------	----------	----------

COMMUNICATIONS DEPARTMENT

A.R.R.L. A-1 Operator Club	55, Jan.; 48, Feb.; 65, Mar.
Brass-Pounders' League	55, Jan.; 65, Mar.; 64, Apr.; 71, May; 49, June; 60, July; 54, Aug.; 52, Sept.; 63, Oct.; 60, Nov.
Breaking into Traffic (Dutton)	63, Mar.
Official Broadcasting Stations	60, Nov.
Supplements	63, Apr.; 70, May; 51, June; 60, July
The A.R.R.L. Emergency Corps	59, Nov.
The New Southwestern Division (K.B.W.)	11, Oct.
Wanted, Volunteers!	49, Aug.
Why Is an ORST? (Castle)	48, Sept.

CONTESTS AND TESTS

1.75-mc. DX Tests	47, Feb.
1935 R.E.F. Cup Contest	47, Feb.
3500- to 4000-kc. Transoceanic Tests (Ann.)	38, Dec.
A Consistent Antipodal Experimental Circuit (Seaton and Lacey)	18, Nov.
Amateur Contests at Brockton Fair	43, Nov.
A.R.R.L. 28-mc. Contest To Be Repeated	56, Nov.
A.R.R.L. Copying Bee (Ann.)	10, Dec.
A.R.R.L. Copying Bee Results	32, June
A.R.R.L.'s Field Day, 1935	34, Sept.
Canada-U. S. A. Contact Contest (Ann.)	48, Nov.
Canada-U. S. A. Contest Results	40, Jan.
Combined VK/ZL International DX Contest	46, Oct.
DX-Contest Highlights	33, May
Five-Hundred Dollar Amateur Competition	15, Mar.
Flash! Winners in VK Contest	15, Apr.
Grunow Competition	10, Dec.
O.P.S. QSO Party Scores	52, Jan.; 68, Mar.; 55, July; 60, Oct.
O.R.S. QSO Party Scores	51, Jan.; 68, Mar.; 55, July; 61, Oct.
Phone-C. W. Contest Results	44, July
Phone-C.W. QSO Contest	20, Feb.
Results, A.R.R.L.'s 1935 DX Contest (Battley)	24, Sept.
Sixth A.R.R.L. Sweepstakes Contest (Handy)	38, Nov.
The 1934 Sweepstakes (Battley)	68, May
The Seventh International Relay Competition (Handy)	34, Feb.
The VE QSO Contest (Trainer)	67, May
Third Annual A.R.R.L. Field Day Contest to Test Portables	22, June
VK-Contest Results (Cunningham)	56, May
Scores	58, June

CONVENTIONS AND HAMFESTS

13th Annual Central Division Convention (Report) Cleveland	88, Dec.
16th Pacific Division Convention (Report) Los Angeles	86, Dec.

1935 Mid-American-Dakota Division Convention (Report) Minneapolis.....	72, Sept.
Atlantic Division Convention (Ann.) Syracuse..	8, May
Atlantic Division Convention (Report) Syracuse	102, Oct.
Central Division Convention (Ann.) Cleveland..	8, Aug.
Dakota Division Convention (Ann.) Minneapolis..	29, Apr.
Delta Division Convention (Ann.) Pine Bluff....	18, Oct.
Hamfests Scheduled.....	32, Feb.; 53, Mar.; 52, Aug.; 37, Oct.
Hawaiian Convention (Report) Honolulu.....	53, Aug.
Hudson Division Convention (Ann.) New York City..	8, May
Hudson Division Convention (Report) N. Y. C.	78, Sept.
Kansas State Convention (Ann.) Topeka.....	12, Oct.
Kansas State Convention (Report) Topeka.....	74, Dec.
Louisiana State Convention (Ann.) New Orleans.	29, Aug.
Maritime Division A.R.R.L. Convention (Report) Halifax.....	94, Oct.
Metropolitan A.R.A. Hamfest.....	42, Jan.
Michigan State Convention (Ann.) Marquette..	31, June
Midwest Division Convention (Ann.) Des Moines.....	29, Apr.
Midwest Division Convention (Report) Des Moines.....	84, Sept.
Milwaukee Hamfest.....	57, May
Missouri State Convention (Ann.) Joplin.....	31, Aug.
Missouri State Convention (Report) Joplin.....	94, Dec.
New England Division Convention (Ann.) Worcester.....	29, Apr.
New England Division Convention (Report) Worcester.....	92, June
Northwestern Division Convention (Ann.) Spokane.....	29, Aug.
Northwestern Division Convention (Report) Spokane.....	76, Dec.
Oklahoma State Convention (Ann.) Ponca City	8, May
Oklahoma State Convention (Report) Ponca City	92, Oct.
Pacific Division Convention (Ann.) Los Angeles..	31, Aug.
Pacific Division Convention (Report) Los Angeles..	12, Sept.
Roanoke Division Convention (Report) Charlotte..	90, Dec.
Rocky Mountain Division Convention (Ann.) Greeley.....	29, Aug.
San Diego Radio Fiesta.....	39, July
South Dakota State Convention (Ann.) Pierre..	39, Aug.
Southeastern Division Convention (Ann.) Miami	39, Oct.
The 1934 Pacific Division Convention.....	84, Feb.
West Coast Hamfests.....	49, Sept.
West Gulf Division Convention (Ann.) Corpus Christi.....	8, Aug.

FEATURES, FICTION AND VERSE

A Burlesque (Connes).....	40, July
A Tribute.....	20, May
Jim—A Tug at Your Memory (Flippin).....	26, Apr.
Matched Impudence (Turnonanoff).....	43, May
Ode to a 210.....	60, Mar.
Shootin' the Works (Hauck).....	33, Jan.
That's What Little Hams Are Made Of	73, May
The Young Squirt's Fourth Epistle to the Old Man.....	40, Dec.
What I've Learned (Burk).....	56, Jan.
Yours Very Truly—Goodnight (Hauck).....	36, Nov.

FILTERS

(See POWER SUPPLY)

FIVE METERS

(See ULTRA HIGH FREQUENCIES)

FREQUENCY CALIBRATION AND CONTROL

Bureau of Standards Extends Standard Frequency Service.....	39, Jan.
Modulated Emissions Added to WWV Standard Frequency Service.....	47, Oct.
Schedules for WWV.....	68, Feb. 94, May 88, Mar. 90, Aug. 102, Nov. 80, Apr. 90, Sept.
Single-Tube E.C. Frequency-Monitor (Exp. Section).....	40, Feb.
Standard Frequency Transmissions.....	68, Feb. 94, May 86, Aug. 102, Nov. 88, Mar. 98, June 90, Sept. 94, Dec. 80, Apr. 84, July 100, Oct.

HAMDOM

25, Jan.....	37, Apr.	35, Aug.	30, Dec.
32, Feb.....	26, June	32, Sept.	
52, Mar.....	38, July	44, Nov.	

I.A.R.U. NEWS

48, Jan.....	55, Apr.	51, July	57, Oct.
43, Feb.....	63, May	47, Aug.	51, Nov.
59, Mar.....	57, June	45, Sept.	49, Dec.
A Short History of the Reseau Belge (Mahieu).....			64, May
Australia.....			51, Nov.
Bolivia.....			46, Sept.
Stepping into MX Land (Okiniishi).....			48, Aug.
Sweden.....			48, Jan.
The Amateur Regulations of the World: 1935..			57, Oct.
WAC during 1934.....			60, Mar.

KEYING

A Simple Remote Control System (Exp. Section).....	46, Aug.
Blocked-Grid Keying (Exp. Section).....	42, Sept.
Chirpless Keying With Pentodes (Exp. Section).....	54, Apr.
Eliminating the Keying Relay Battery (Exp. Section).....	45, Jan.
Improved Keying-Tube Circuit (Exp. Section).....	41, Dec.
Keying-Relay Circuit Clicks (Exp. Section).....	55, Mar.
Keying System (Exp. Section).....	45, Aug.
More on Eliminating Thumps (Exp. Section).....	55, Mar.
RK-20 Keying Circuits (Exp. Section).....	53, Apr.
Sliding Bug Weight (Exp. Section).....	72, Jan.
Suppressor-Grid Keying (Exp. Section).....	39, Feb.
Washing Out the B.C. Interference (Exp. Section).....	40, Feb.

METERS AND MEASUREMENTS

A Multi-Purpose Test Circuit (Kirk).....	35, Oct.
A Self-Powered V.T. Voltmeter of High Sensitivity (Duncan).....	42, Oct.
A Simple Photographic Recorder for the Experimentor (Hull).....	27, Mar.
Another Way of Multi-Metering (Exp. Section).....	52, Apr.
Field-Strength Meter (Exp. Section).....	84, June
Milliammeter Switching for Grid and Plate Currents (Exp. Section).....	41, Dec.
Phone Monitor and Modulation Meter (Exp. Section).....	54, Mar.
Phone Monitor—V.T. Voltmeter (Exp. Section).....	41, June
Remagnetizing Readrite Milliammeters (Exp. Section).....	55, Oct.
Using a Voltmeter as an Ohmmeter (Exp. Section).....	42, June

MISCELLANEOUS

A Homemade World Time Clock (Newell).....	45, Oct.
A New Radio Transmission Phenomenon.....	21, Dec.
A.R.R.L. QSL Bureau.....	84, Mar.; 98, May; 87, June; 84, July; 31, Aug.; 82, Sept.; 90, Oct.; 17, Nov.; 39, Dec.
Election Notices (Directors).....	22, Sept.; 24, Oct.
Election Notices (Section Communications Manager).....	50, Feb.; 51, June; 65, Oct.

EDITORIALS

A.R.R.L.'s Twenty-first Birthday (K. B. W.).....	12, Oct.
Automobile Ignition Interference (K. B. W.).....	7, Jan.
Boottleg 56-mc. Stations (K. B. W.).....	7, May
Improved Amateur Regulations (K. B. W.).....	7, Aug.
Improved Phone Operation (K. B. W.).....	9, Dec.
Interference and Receivers (K. B. W.).....	7, June
License Renewal Trouble (K. B. W.).....	7, Feb.
"Losses" (K. B. W.).....	11, Oct.
Monitoring Policy of the F.C.C. (K.B.W.).....	7, May
QRM (K. B. W.).....	11, Sept.
Short-Wave Broadcasting (K. B. W.).....	7, Jan.
Sociological Study of Amateur Radio (K. B. W.).....	9, Mar.
The Board of Directors (K. B. W.).....	9, Nov.
The Board of Directors Meeting (A. L. B.).....	7, Apr.
The Cairo Committee (K. B. W.).....	9, July
The "Good Old Days".....	9, Mar.
The New Southwestern Division (K. B. W.).....	11, Oct.
Thievery of Amateur Apparatus (K. B. W.).....	7, Jan.

EMERGENCY AND RELIEF WORK

Alaskan Service.....	52, Aug.
Amateurs Aid in Lost Plane Search.....	12, Feb.
Amateurs Locate Stranded Yacht.....	51, Sept.
Amateurs on the Job in Florida Hurricane.....	60, Oct.
Amateur Radio Scores Again! (Jenkins).....	45, Feb.
B.C. Hams Prove Their Mettle.....	66, Mar.
Emergencies, Maryland-Delaware-Virginia.....	60, Apr.
Flood Emergency Communication.....	50, Aug.
Flood Emergency Work.....	54, July
Minnesota/Wisconsin Emergency.....	70, May
Mississippi Flood.....	61, Apr.
More on B.C. Emergency.....	61, Apr.
More on the Duluth Fleet Storm (Johnson).....	48, June
QRR—New York Flood.....	50, Sept.

EXPEDITIONS

Amateurs Around the World by Plane (Wilson).....	11, Mar.
Andes-Amazon Expedition.....	63, Oct.
Bol-Inca Expedition—CPIGB.....	53, Jan.
K6BAZ Operator on Schooner Kinkajou.....	47, Sept.
Schooner Morrissey, WIOXFP.....	49, Aug.
The Equipment on the "Morrissey" (Moe).....	16, Oct.

Election Results (Directors)	26, Feb.
Election Results (Section Communications Manager)	64, Apr.; 51, June; 56, Aug.; 66, Oct.
How to Count Countries Worked (DeSoto)	40, Oct.
Improving Club Interest (Rigor)	53, July
Milwaukee "Bootleg" Situation Under Control (Kaetel)	51, Sept.
New Code Champion	34, Oct.
On the Origin of 73	60, Apr.
One Ham's Journey (C. B. D.)	31, Jan.
QSL Bureaus	76, Sept.
Soldering-Iron Holder (Exp. Section)	50, Nov.
Soldering-Iron Outlet (Exp. Section)	50, Nov.
The Old-Timer Learns About Modern Dress (Hubbell)	39, Mar.
World Championship Radio Code Speed Tournament (McElroy)	24, Nov.

MONITORS

"B" Power for the Keying Oscillator (Exp. Section)	56, Oct.
Continuous Monitoring With the Regenerative S.S. Super (Exp. Section)	55, Oct.
Identifying the Frequency Signal on a Superhet (Exp. Section)	46, Aug.
Monitoring Without a Monitor (Exp. Section)	55, Mar.
More on Switchless Monitoring (Exp. Section)	42, Dec.
Phone Monitor and Modulation Meter (Exp. Section)	54, Mar.
Phone Monitor—V. T. Voltmeter (Exp. Section)	41, June
Simple Keying Oscillator (Exp. Section)	56, Oct.
Single-Tube E.C. Frequency-Monitor (Exp. Section)	40, Feb.

NAVAL COMMUNICATIONS RESERVE

Hams Afloat	61, Nov.
Navy Day—1934 (Battley)	40, Mar.
Navy Day Receiving Competition	62, Oct.

OBITUARY

Clair Foster, W6HM	17, Nov.
Mrs. Isabelle W. Moody, W7DHF	82, Dec.
Silent Keys:	
66, Jan.	86, June
82, Mar.	38, July
	102, Oct.
	57, Nov.
	45, Dec.

OPERATING PRACTICES

A Test of CQ's (Burton)	65, Oct.
About Ham Message Handling	40, Aug.
Beginners, QRM and Restrictions (Wood)	47, Feb.
Break-In (Aymer and Davis)	53, Jan.
Breaking Into Traffic (Dutton)	63, Mar.
CQ DX (Magill)	47, June
Directional CQ's (Anderson)	55, Aug.
DX Technique (Perrine)	59, Apr.
Hints on Improved Keying (McElroy)	56, Nov.
Operating Savvy	49, Nov.
QRP (Grammer)	68, May
Receiving Ability (Jenkins)	73, May
Standard Practices	54, Nov.
Station and Operating Efficiency (Moxey)	106, Oct.
The Revised R-S-T System	30, June
Trunk Line "C" (Bruning)	59, Oct.
Use 9-Point S Scale in Your R-S-T's	

POWER SUPPLY

A More Efficient Impeller for Wind-Driven Generators (Lynch)	48, Apr.
Fluorescent Voltage Regulator (Exp. Section)	44, Jan.
Inexpensive Fuses (Exp. Section)	43, June
More on Gaseous Voltage Regulators for Receiver "B" Supplies (Robinson)	29, Jan.
Power Supply for Multi-Stage Transmitters (Exp. Section)	43, Jan.
Power Transformer Design Circular	98, Dec.
Rectifier Switching for Voltage Changing (Exp. Section)	59, May
Safe Starting and Excitation-Failure Protection (Exp. Section)	56, Mar.
Vacuum-Tube Voltage Regulators (Priest and Olney)	46, July.

RADIO TELEPHONY

(See also U. H. F., APPARATUS)

A Compact "200-Watt" Transmitter (Webb)	16, Apr.
A Complete 20-Watt Phone Operating on 110-Volt D. C. Mains (Spencer and Purinton)	9, June
A "Fly-Power" Phone Transmitter Using a 6A7 (Exp. Section)	41, Dec.
A New High-Efficiency High-Gain Audio Power Amplifier (Brewster and Bellem)	45, Mar.
A New Type Crystal Microphone	96, June
A Quick-Switch Phone Transmitter for Two-Band Operation (Millen)	18, Nov.

A Simple Neon-Tube Oscilloscope for Amateur Use (Vollmer)	48, Oct.
Adjusting the Phone Transmitter for Best Modulation Performance (Lent)	24, Aug.
Automatic Carrier Switching (Exp. Section)	39, Feb.
Automatic Microphone Battery Switch (Exp. Section)	40, Feb.
Background for Single-Side-Band Phone (Lamb)	33, Oct.
Choke-Coupled Modulation of R.F. Pentodes (Exp. Section)	49, Nov.
Class-B Carrier Control in the Low-Power Phone (Keen)	25, Dec.
Duplex Phone (Exp. Section)	43, Sept.
Frequency Modulation and Major Armstrong	21, Sept.
Further Controlled-Carrier Phone Systems	37, July
Greater Economy in Class-B Modulation Design for Speech (Grammer)	9, Aug.
Grid-Bias Modulation for the General Purpose Transmitter	17, Mar.
Grid-Bias Modulation of the 100-Watt Type Power Amplifier (Wirkler and Collins)	29, Mar.
More Audio Watts from a Single Type 10 (McCConnell and Raspet)	32, Mar.
Neutralizing the Class-B Modulator for Greater Fidelity (Burriss)	34, Mar.
New Crystal Microphones	78, Dec.
New Microphones	98, May
Overmodulation and Modulation Metering (J. J. L.)	21, June
Phone Transmission With Voice-Controlled Carrier Power (Fyler)	9, Jan.
Plate Modulation of Pentodes (Grammer)	13, Sept.
Remote Control, Push-to-Talk (Exp. Section)	44, Jan.
Screen-Grid Supply with Suppressor-Grid Modulation	38, Mar.
Simple Methods of Checking Modulation to Comply With the New Regulations (Lamb)	32, Aug.

RECEIVERS—REGENERATIVE

A Portable Receiver That Delivers the Goods (Vanderpool)	28, June
Improving Detector Stability (Exp. Section)	48, July
Midget Portable Receiver (Exp. Section)	53, Oct.

RECEIVERS—SUPERHETERODYNE

A 1935 Version of the Original S.S. Superhet (Hubbell)	44, May
A New Type of Two-Terminal Oscillator Circuit	45, Apr.
A Novel Dual-Tuner Superhet (Browning)	29, Nov.
An All-Purpose S.S. Superhet With Turret-Type Automatic Coil Changing (Fisher)	13, Aug.
Coil Data for "All-Purpose" S.S. Superhet	17, Sept.
An Audio Output Stage for the Regenerative S.S. Receiver (Exp. Section)	42, Sept.
Iron Core I.F. Transformers (Crossley)	22, Aug.
Looking Over the Circuits of the New Amateur-Band Superhets (Lamb)	21, May
Modern Design of High-Frequency Stages for the Amateur Superhet (Millen and Bacon)	13, Jan.
More Effective Pre-Selectors for Our Receivers	35, Mar.
Notes on Regenerative S.S. Receiver	42, Dec.
Regenerative Amplification at Signal Frequency (Exp. Section)	41, Dec.
Stabilizing the 2A7 Converter (Exp. Section)	53, Oct.
The Application of Iron-Core I.F. Transformers to Amateur-Band Superhet Design (Detrick and Morrison)	36, Aug.

RECEIVING—GENERAL

A Cure for Receiver Hum (Exp. Section)	60, May
A Detector Circuit for Reducing Noise Interference in C.W. Reception (Thompson)	38, Apr.
A New Filter-Speaker	80, Sept.
About Band-Spread	28, May
Antenna-Filter for Reception (Exp. Section)	59, May
Eliminating Hum Modulation (Exp. Section)	44, Jan.
More on Gaseous Voltage Regulators for Receiver "B" Supplies (Robinson)	29, Jan.
Receiver Selectivity Characteristics (Lamb)	37, May
Regenerative Amplification at Signal Frequency (Exp. Section)	41, Dec.
Resistor Color Code	104, Mar.

TEN METERS

(See ULTRA HIGH FREQUENCIES)

TRANSMITTERS—PORTABLE AND LOW POWER

A Complete Battery-Operated Portable Station (Van Deusen)	30, July
A "Fly-Power" Phone Transmitter Using a 6A7 (Exp. Section)	41, Dec.
A Generator Crystal-Controlled Portable Using 6-Volt Tubes (Waddingham)	23, July
An Experimental Station on Wheels (Selvidge)	25, July

Battery-Operated Portable Transmitter (Exp. Section).....	52, Apr.
Portable 75-Meter Phone (Exp. Section).....	58, May
Radio Equipment of General Utility (Robinson)	15, July
Rotary Polarity-Reversing Switch.....	88, Mar.

Vitreous R.F. Chokes.....	82, Mar.
What's in a Circuit (Grammer).....	19, Oct.
Why Does Automatic Grid Bias (Girkin).....	19, Jun.

TRANSMITTERS—MEDIUM AND HIGH POWER

A Compact "200-Watt" Transmitter (Webb)...	16, Apr.
A Complete 20 Watt Phone Operating on 110-Volt D.C. Mains (Spencer and Purinton)....	9, June
A Flexible E.C.—Controlled Transmitter (Learned).....	38, Sept.
A Four-Band Exciter (Hollister).....	21, July
A General Purpose 50 Watt Transmitter (Grammer).....	16, Jan.
A Modernized "Modern" Transmitter (Walleze)	30, Apr.
An R.K-20 Tri-Tet Transmitter for Three-Band Operation (Grammer).....	41, Apr.
Band Switching in the Universal Exciter Unit (Southworth).....	38, Feb.
Do You Want a Kilowatt? (Mix).....	8, Apr.
Four Bands with Two Tubes (Gow).....	18, Aug.
The Equipment on the "Morrissey" (Moe).....	16, Oct.
What's in a Circuit? (Grammer).....	19, Oct.

TRANSMITTING—CRYSTAL CONTROL

Better Crystal Stability without a Heater Oven (Dillard).....	34, Jan.
Cutting Quartz Crystal Plates (Loucks).....	36, Jan.
Grinding and Finishing Quartz Crystal Plates (Loucks).....	28, Feb.
High-Frequency Crystals of New Type Cut ...	23, Nov.
New All-Metal Crystal Holder.....	94, May
Oscillators Using 14-mc. Quartz Crystals (Wolf-skill).....	19, Dec.
Practical Operating Advantages of Low Temperature-Frequency Coefficient Crystals (Baldwin and Bokovoy).....	26, Jan.
Speeding Up Rough Grinding (Exp. Section)...	58, May

TRANSMITTING—GENERAL

A Frequency-Lock Multi-Vider (De Young) ...	32, Sept.
A New Radio Transmission Phenomenon.....	21, Dec.
Automatic Carrier Switching (Exp. Section)...	39, Feb.
Automatic Protection with Grid Leak Bias (Exp. Section).....	54, Oct.
Band Switching in the Universal Exciter Unit (Southworth).....	38, Feb.
Caliper Coupling (Exp. Section).....	54, Apr.
Crystal-Locked Hartley Oscillator (Exp. Section)	54, Mar.
Doublet Receiving Antenna and Bucking Circuit for Duplex Operation (Seeley).....	28, Jan.
Eliminating Hum Modulation (Exp. Section) ..	44, Jan.
Filament Voltage Regulator (Exp. Section)....	44, Jan.
Harmonic Suppression (Exp. Section).....	54, Apr.
Inexpensive Utility Switchboard Type Racks (Van Duzne).....	18, Dec.
More Effective Link Coupling for R.F. Power Amplifiers (Foreman).....	34, Apr.
Neutralizing the Final (Exp. Section).....	53, Oct.
Note on the "R" Circuit (Exp. Section).....	43, Jan.
Power Supply for Multi-Stage Transmitters (Exp. Section).....	43, Jan.
Push-Pull-Push Oscillator Circuits for 15-Watt Second Harmonic Output (Brown).....	53, May
QRP (Grammer).....	40, Nov.
R.F. Return Circuit in Interstage Coupling (Friend).....	50, Mar.
Reducing Power (Exp. Section).....	48, July
Remote Control, Push-to-Talk (Exp. Section) ..	44, Jan.
Self Regulating Grid-Bias Supply for Multi-Stage Transmitters (Friend).....	24, Dec.
Suggestions Wanted (Exp. Section).....	60, May
Time Delay Relay Using a 45 Tube (Exp. Section).....	41, June
TNT "R" Circuit (Exp. Section).....	55, Oct.
Type 59 Tube as Inverted Amplifier (Exp. Section).....	42, June

TUBES

A New 100-Watt Type Zero-Bias Transmitting Tube.....	27, Jun.
A New Hot-Cathode Gaseous Discharge Amplifier and Oscillator (Nelson and Le Van)...	23, Jun.
Acorn-Type Pentode Announced.....	42, Mar.
Blue Glow in Tubes.....	66, Jan.
Data on the Metal-Shell Receiving Tubes.....	35, July
New 2-Volt Battery Duo-Diode-Triode.....	52, Oct.
New Class-B Tubes With 125-Watt Output Rating.....	15, Mar.
New High-Power Transmitting Pentode.....	28, July
New Type Metal-Shell Receiving Tubes Announced for Summer Appearance.....	36, Mar.
Operating Notes on the New Pentodes.....	29, Feb.
The 803—High-Power Pentode.....	30, Aug.

ULTRA-HIGH FREQUENCIES—APPARATUS

A New Receiving System for the Ultra-High Frequencies (Hull).....	I 10, Nov.
II 31, Dec.	
A New Type Ultra-High-Frequency Transmitter (King).....	30, Sep.
An Experimental Station on Wheels (Selvidge) ..	25, July
Another Successful 56-mc. Directive Antenna....	15, Feb.
Design for Higher Performance in the Super-Regenerative Receiver (Fyler).....	11, July
Progress in Ultra-High-Frequency Gear (Hull) ..	30, May
R.F. Indicators for Ultra-High Frequencies (Exp. Section).....	49, July
Rationalizing the Resonant-Line U.H.F. Oscillator (Friend).....	26, Nov.
Reducing QRM on 56-mc. (Hadlock).....	27, Oct.
Stabilizing the Ultra-High-Frequency Transmitter (Hull).....	13, Feb.
Stepping Up the Output of the High-Stability 56-mc Transmitter (Conrad).....	14, Apr.
Two-Band U.H.F. Transceiver (Exp. Section) ..	44, Sept.

ULTRA-HIGH FREQUENCIES—TESTS

28-mc. Activities.....	51, Aug.
28-mc. Communication Continues.....	16, Nov.
28-mc. WAC Accomplished.....	11, Dec.
Air-Mass Conditions and the Bending of Ultra-High Frequency Waves (Hull).....	13, Jun.
A.R.R.L. 28-mc. Contest To Be Repeated.....	56, Nov.
Five-Meter Signals Do the Impossible.....	17, Aug.
Hartford-Boston Link Established on Two and One-half Meters (Hull).....	16, Mar.
International 28-mc. Communication Again! (Grammer).....	9, May
New 56-mc. Records in the Making.....	56, July
On Top of the U. S. (Wallace).....	13, Oct.
Progress on the Ultra-High Frequencies (Hull) ..	35, Jan.
Stratosphere Balloon Radio Tests.....	8, June
Ten Meter Activity Increasing.....	20, Aug.
W1XR (McKenzie).....	33, July
W2MO, Portable, Sets the Pace on 56-mc. (Diecks).....	31, Oct.

WHAT THE LEAGUE IS DOING

24, Jan.	51, Apr.	26, July	24, Oct.
26, Feb.	18, May	27, Aug.	25, Nov.
44, Mar.	33, June	22, Sept.	22, Dec.
Minutes of 1935 Board Meeting.....			34, June

WITH THE AFFILIATED CLUBS

42, Jan.	50, Apr.	42, July	37, Oct.
32, Feb.	57, May	38, Aug.	45, Nov.
53, Mar.			46, Dec.